

№ФОРВАРДА	№ OEM	№ NISSENS	МОДЕЛЬ	ТИП ДВИГАТЕЛЯ	БЕН/Д ИЗ	ТИП КП	КОНД ИЦИ	ГОД	ПРИМЕЧА НИЕ
-----------	-------	-----------	--------	---------------	-------------	-----------	-------------	-----	----------------

РАДИАТОРЫ ОХЛАЖДЕНИЯ

А108082-910	855121251F/A/D/E/893121251K/F	60441	AUDI 80 '82-94 РАДИАТОР ОХЛАЖДЕН (NISSENS)						477 377 42
-------------	-------------------------------	-------	--	--	--	--	--	--	------------



80 II 1,9 5S CD	1921WN	G	MA	*	8/81-7/83
80 II 2,0 CD 5S	1994JS	G	MA	*	7/83-9/86
80 II 2,2 CD 5E/GL 5E	2226WE	G	MA		8/81-7/83
80 III 2,0 E	1994PS	G	M	*	4/87-9/91
80 IV 2,3 E	2309NG	G	M		9/91-12/94
80 QUATTRO 2,2 E	KK	G	M		8/82-7/84
80 QUATTRO 2,3 E	2309NG	G	M		9/91-12/94
90 2,0	1994SK	G	M		2/86-8/87
90 2,0	1994JS	G	M		8/84-8/87
90 2,2	2226KV	G	M		10/84-8/87
90 2,2	2226KX	G	M		4/85-8/87
90 II 2,0	1994PS	G	M	*/-	4/87-12/91
90 II 2,0 20V	1994NM	G	M		8/88-9/91
90 II 2,2 E	2226KV	G	M		4/87-12/91
90 QUATTRO 2,2 QUATTRO	2226JT	G	M		8/85-3/87
90 QUATTRO 2,2 QUATTRO	2226KV	G	M		8/84-3/87
90 QUATTRO 2,2 QUATTRO	2226KV	G	M		4/87-12/91
90 QUATTRO 2,3 QUATTRO	2309NG	G	M		4/87-12/91
90 QUATTRO 2,3 QUATTRO 20V	2309 7A	G	M		6/88-12/91
COUPE 1,9 GT	1921WN	G	M		10/80-8/83
COUPE 2,0 GT	1984SK	G	M		4/86-7/87
COUPE 2,0 GT 5S	1984JS	G	M		9/83-7/87
COUPE 2,1 GT 5E	2144KE	G	M		4/82-9/84
COUPE 2,2 GT	2226KX	G	M		4/85-7/87
COUPE 2,2 GT	2226KV	G	M		8/84-7/87
COUPE II 2,0	1984NM	G	M		8/89-
COUPE II 2,2	2226KV	G	M		11/88-
COUPE II 2,3	2309KV	G	MA		11/88-7/91
COUPE II 2,3	2309NG	G	MA		11/88-
COUPE II 2,3	2309 7A	G	MA		8/89-7/91



А108083-911	893121253/811121253F/D	60461	AUDI 80 '83-91 РАДИАТОР ОХЛАЖДЕН (NISSENS)						430 322 33
-------------	------------------------	-------	--	--	--	--	--	--	------------





А108083-912	893121253/811121253F/D	60461	AUDI 80 '83-91 РАДИАТОР ОХЛАЖДЕН						430 322 33
-------------	------------------------	-------	----------------------------------	--	--	--	--	--	------------



80 II 1,3 C/CL/L/GL	1272EP	G	M		8/87-9/86
80 II 1,6 C/CC/CD	1588SA	G	MA		2/86-9/86
80 II 1,6 C/CC/CD/CL/GL	1588DT	G	MA		8/83-9/86
80 III 1,6	1595RN	G	M		9/86-9/91
80 III 1,6	1595PP	G	M		3/87-9/91
80 II 1,8	1781RU/RS	G	MA		9/86-1/90
COUPE 1,6 GL	1588DD	G	MA		8/83-6/84
COUPE 1,8 CL/GL/GT	1781DS	G	MA		8/83-6/84

№ФОРВАРДА	№ OEM	№ NISSENS	МОДЕЛЬ	ТИП ДВИГАТЕЛЯ	БЕН/Д ИЗ	ТИП КП	КОНД ИЦИ	ГОД	ПРИМЕЧА НИЕ
AI08087-910	893121251F/K	60330	AUDI 80 '87-91 (90) РАДИАТОР ОХЛАЖДЕН (NISSENS)						470 278 34
			80 III 2,0 E	1994PS	G	M		4/87-9/91	
			90 II 2,0 20V	1994NM	G	M		8/88-9/91	
			COUPE 2,0 GT 5S	1921WN	G	M		9/80-7/83	
AI08087-911	893121251	60487A	AUDI 80 '86-91 РАДИАТОР ОХЛАЖДЕН (NISSENS)						600 308 42
			80 III 1,6	1595AAB	G	MA	*/-	9/90-9/91	
			80 III 1,6 D	1588JK	D	M		9/86-8/89	
			80 III 1,6 E	1595AAB	G	M	*	9/86-9/91	
			80 III 1,6 TURBO DIESEL	1588SB	D	MA		4/89-9/91	
			80 III 1,6 TURBO DIESEL	1588RA	D	M		8/87-4/89	
			80 III 1,9 D	1896 1Y	D	M		8/89-9/91	
			80 III 1,9 E	1921SD	G	MA		9/86-8/89	
			80 QUATTRO 1,8 GTE	1781DZ	G	M		9/86-9/91	
			80 QUATTRO 1,8 S	1781SF	G	M		9/86-7/89	
			80 QUATTRO 1,8 S	1781NE/JN	G	M		9/86-9/91	
			80 QUATTRO 1,9 E	1921SD	G	M		9/86-7/88	
			80 QUATTRO 2,0 E	1994 3A	G	M		8/88-12/90	
			80 QUATTRO 2,0 E	1994AAD	G	M		10/90-9/91	
			90 II 1,6 TURBO DIESEL	1588RA/SB	D	M		4/88-12/91	
AI08087-912	893121251/251A/253A	60436	AUDI 80 '87-94 РАДИАТОР ОХЛАЖДЕН (NISSENS)						590 310 33
AI08087-913	893121251/251A/253A	60436	AUDI 80 '87-94 РАДИАТОР ОХЛАЖДЕН						590 310 33
			80 AVANT 2,0	1994ABT/ABK	G	M		9/92-12/94	
			80 III 1,6	1595AAB	G	MA		9/90-9/91	
			80 III 1,8 E	1781DZ	G	M		9/86-9/91	
			80 III 1,8 S	1781JN/NE	G	MA		9/86-01/90	
			80 III 1,8 S	1781PM	G	MA		3/88-9/91	
			80 III 1,9 E	1921SD	G	M		9/86-8/89	
			80 III 2,0 E	1984 3A	G	MA		8/88-9/91	
			80 III 2,0 E	1984AAD	G	M		3/90-9/91	
			80 IV 1,6	1595ABM	G	M		9/91-12/94	
			80 IV 2,0	1984ABT	G	M		9/91-7/92	
			80 IV 2,0 E	1984ABK	G	M		9/91-12/94	
			80 QUATTRO 1,8 GTE	1781DZ	G	M		9/86-9/91	
			80 QUATTRO 1,8 S	1781SF	G	M		9/86-7/90	
			80 QUATTRO 1,8 S	1781NE/JN	G	M		9/86-9/91	
			80 QUATTRO 1,9 E	1921SD	G	M		9/86-7/88	
			80 QUATTRO 2,0 E	1994 3A	G	M		8/88-12/90	
			80 QUATTRO 2,0 E	1994AAD	G	M		10/90-9/91	
			80 QUATTRO 2,0 E	1994ABK	G	M		9/91-12/94	
			COUPE II 1,8	1781DZ	G	M		8/89-7/91	
			COUPE II 2,0	1984 3A	G	MA		8/89-7/90	
			COUPE II 2,0	1984AAD	G	MA		8/90-8/91	
			COUPE II 2,0	1984ABK	G	M		9/91-	
			COUPE II 2,0 16V	1984 6A	G	M		01/92-	
			COUPE II 2,0 16V	1984ACE	G	M		8/92-	

№ФОРВАРДА	№ OEM	№ NISSENS	МОДЕЛЬ	ТИП ДВИГАТЕЛЯ	БЕН/Д ИЗ	ТИП КП	КОНД ИЦИ	ГОД	ПРИМЕЧА НИЕ
AI08091-910	8AO121251A	60448A	AUDI 80 '91-94 РАДИАТОР ОХЛАЖДЕН (NISSENS)						596 359 32
			AUDI 80/90 1,9 Tdi	1896 1Z	D	A	*/-	92/1-95/7	
			AUDI 80/90 2,0 i	1984 ABK	G	A	*/-	91/9-95/7	
			AUDI 80/90 2,0 i	1984 ABT	G	A	*/-	91/9-95/6	
			AUDI 80/90 2,0 i	1984 ACE	G	A		92/8-95/7	
			AUDI 80/90 2,0 i	1984 ADW	G	A	*/-	93/12-95/9	CN,RU
			AUDI 80/90 2,0 i 16V	1984 6A	G	A		91/9-94/12	
			COUPE 2,0 i	1984 ABK	G	A	*/-	91/8-95/12	
AI08091-911	893121251G/S	60442	AUDI 80 '91-94 (90 88-) РАДИАТОР ОХЛАЖДЕН (NISSENS)						477 377 42
			80 IV 2,3 E	2309NG	G	M	*	9/91-12/94	
			80 QUATTRO 2,3 E	2309NG	G	M	*	9/91-12/94	WAFTC
			90 AVANTO Q 2,3 QUATTRO	2309NG	G	M	*	9/92-12/94	WAFTC
			90 II 2,0 20V	1994NM	G	M	*	8/88-9/91	WAFTC
			90 II 2,0 20V	1994NM	G	A	*	8/88-9/91	WAFTC
			90 II 2,2 E	2226KV	G	M	*	4/87-12/91	WAFTC
			90 II 2,3	2309 7A	G	MA	*	4/90-12/91	WAFTC
			90 II 2,3 20V	2309 7A	G	MA	*	8/89-12/91	WAFTC
			90 II 2,3 E	2309NG	G	MA	*	4/87-12/91	WAFTC
			90 QUATTRO 2,2 QUATTRO	2226KV	G	M	*	4/87-12/91	WAFTC
			90 QUATTRO 2,3 QUATTRO	2309NG	G	M	*	4/87-12/91	WAFTC
			90 QUATTRO 2,3 QUATTRO	2309 7A	G	M	*	4/90-12/91	WAFTC
			90 QUATTRO 2,3 QUATTRO 20V	2309 7A	G	M	*	6/88-12/91	WAFTC
			CABRIO 2,3	2309NG	G	M	*	6/91-	WAFTC
			COUPE II 2,0	1984NM	G	M		8/89-	WAFTC
			COUPE II 2,3	2309 7A	G	MA		8/89-7/91	WAFTC
			COUPE Q 2,0 QUATTRO	1994NM	G	M	*	8/89-	WAFTC
COUPE Q 2,2 S2	2226 3B	G	M		9/90-				
COUPE Q 2,3 QUATTRO	2309NG	G	M	*	8/89-	WAFTC			
COUPE Q 2,3 QUATTRO 20V	2309 7A	G	M		11/88-	WAFTC			
AI08091-912	8AO121251	60465A	AUDI 80 '91-94 РАДИАТОР ОХЛАЖДЕН (NISSENS)						595 358 33
			80 AVANT 1,9 TDi	1896 1Z	G	M		9/92-5/94	
			80 AVANT 2,0	1994ABT/ABK	G	M	*	9/92-12/94	
			80 AVANT 2,0	1994ACE	G	M		8/92-12/94	
			80 IV 1,6	1595ABM	G	M	*	9/91-12/94	
			80 IV 1,9 TDi	1896 1Z	D	M		01/92-5/94	
			80 IV 2,0	1984ABT	G	M	*	9/91-7/92	
			80 IV 2,0	1984ACE	G	M		8/92-12/94	
			80 IV 2,0 16V	1984 6A	G	M		9/91-12/94	
			80 IV 2,0 E	1984ABK	G	M	*	9/91-12/94	
			80 QUATTRO 2,0 E	1994ABK	G	M	*	9/91-12/94	
80 QUATTRO 2,0 E	1994 6A	G	M		9/91-7/92				
80 QUATTRO 2,0 E	1994ACE	G	M		8/92-12/94				

№ ФОРВАРДА	№ OEM	№ NISSENS	МОДЕЛЬ	ТИП ДВИГАТЕЛЯ	БЕН/Д ИЗ	ТИП КП	КОНД ИЦИ	ГОД	ПРИМЕЧА НИЕ
AI08091-913	8A0121251E/G	60466A	AUDI 80 '91-94 РАДИАТОР ОХЛАЖДЕН МТ 1.9 (турбодизель) (NISSENS) AUDI 80/90 1.9 TD CABRIOLET 1,8 i	1896 AAZ 1781 ADR	D G	M M	*- *-	91/9-95/7 97/4-00/8	595 409 32
									
AI0A494-910	8D0121251K	60491A	AUDI A4 '94-96 РАДИАТОР ОХЛАЖДЕН (NISSENS) A4 1,6 E A4 1,8 E 20V A4 1,8 E TBO 20V A4 1,9 TDI	1595ADP 1781ADR/AFY/AEB 1781AEB 1896 1Z/AFF/AFN	G G G D	M M M M	*- *- *- *-	10/94-2/96 10/94-2/96 10/94-2/96 10/94-2/96	632 398 32
									
AI0A494-912	8D0121251B	60495A	AUDI A4 '94-96 РАДИАТОР ОХЛАЖДЕН A4 2,6 E A4 2,8 E	2598 ABC 2771 AAH/AFC	G G	A A	*- *-	10/94-2/96 10/94-2/96	632 399 32
									
AI0A496-912	8D0121251M	60499A	AUDI A4 '96-00 {A6 97-/PASSAT 96-} РАДИАТОР ОХЛАЖДЕН (NISSENS)	1595ADP	G	A	*-	3/96-	632 399 32
AI0A496-914	8D0121251M/BC	60499A	AUDI A4 '96-00 {A6 97-/PASSAT 96-} РАДИАТОР ОХЛАЖДЕН A4 1,6 E A4 1,8 E 20V A4 1,8 E TBO 20V A4 1,9 TDI A6 II 1,8 E 20V A6 II 1,8 E 20V A6 II 1,8 E 20V TURBO A6 II 1,9 TDI PASSAT V 1,8 20V	1781ADR/AFY/AEB 1781AEB 1896 1Z/AFF/AFN 1781AFY 1781AJP 1781AEB 1896AFN 1781ADR/AFY	G G G D G G G D G	A A A A A A A A A	*- *- *- *- *- *- *- *- *-	3/96- 3/96- 3/96- 3/96- 5/97- 12/97- 4/97- 4/97-12/97 10/96-	632 399 32
									

№ФОРВАРДА	№ OEM	№ NISSENS	МОДЕЛЬ	ТИП ДВИГАТЕЛЯ	БЕН/Д ИЗ	ТИП КП	КОНД ИЦИ	ГОД	ПРИМЕЧА НИЕ
AI0A496-913	8D0121251P/AJ/K/Q	60489A	AUDI A4 '96- {A1 A6 97-/PASSAT 96-} РАДИАТОР ОХЛАЖДЕН (NISSENS)						632 398 22
AI0A496-915	8D0121251P/AJ/K/Q	60489	AUDI A4 '96- {A1 A6 97-/PASSAT 96-} РАДИАТОР ОХЛАЖДЕН						632 398 22
			A4 1,6 E	1595ADP	G	M	*	3/96-	
			A4 1,6 E	1595ADP	G	M	*	3/96-	
			A4 1,8 E 20V	1781ADR/AFY/AEB	G	M	*	3/96-	
			A4 1,8 E 20V	1781ADR/AFY/AEB	G	M	*	3/96-	
			A4 1,8 E TBO 20V	1781AEB	G	M	*	3/96-	
			A4 1,8 E TBO 20V	1781AEB	G	M	*	3/96-	
			A4 1,9 TDI	1896 1Z/AFF/AFN	D	M	*	3/96-	
			A4 1,9 TDI	1897 1Z/AFF/AFN	D	M	*	3/96-	
			A6 AVANT 1,8 T	1781ARK	D	M	*/-	12/97-	
			A6 AVANT 1,8 T	1781AEB	G	M	*/-	12/97-	
			A6 AVANT 1,8 T	1781ANB	G	M	*/-	12/97-	
			A6 AVANT 1,8 T	1781APU	G	M	*/-	12/97-	
			A6 II 1,8 E 20V	1781AFY	G	M	*/-	5/97-	
			A6 II 1,8 E 20V	1781AJP	G	M	*/-	7/97-	
			A6 II 1,8 E 20V TURBO	1781AEB	G	M	*/-	4/97-	
			A6 II 1,8 E 20V TURBO	1781AJL	G	M	*/-	11/97-	
			A6 II 1,9 TDI	1896AFN	D	M	*/-	4/97-12/97	
PASSAT V 1,6	1595ADP/AHL	G	M	*/-	10/96-				
PASSAT V 1,8 20V	1781ADR/AFY	G	M	*/-	10/96-				
PASSAT V 1,8 TURBO 20V	1781AEB	G	M	*/-	10/96-				
PASSAT V 1,9 TDI	1896AFN/AHU	D	M	*/-	10/96-				
AI0A496-911	8D0121251L	60498A	AUDI A4 '96-00 РАДИАТОР ОХЛАЖДЕН (NISSENS)						632 399 32
AI0A496-916	8D0121251L	60498	AUDI A4 '96-00 РАДИАТОР ОХЛАЖДЕН						632 399 32
			A 4 / S 4 (94-) 2.4 i V6	AGA/AJG/ALF	G	A	+/-	08/97 -	
			A 4 / S 4 (94-) 2.4 i V6	AML/APS/APZ/ARJ	G	A	+/-	08/98 -	
			A 4 / S 4 (94-) 2.6 i V6	ABC	G	A	+/-	11/94 -	
			A 4 / S 4 (94-) 2.6 i V6	ACZ	G	A	+/-	01/96 -	
			A 4 / S 4 (94-) 2.8 i V6	AAH	G	A	+/-	11/94 -	
			A 4 / S 4 (94-) 2.8 i V6	ACK	G	A	+/-	03/96 -	
			A 4 / S 4 (94-) 2.8 i V6	ALG	G	A	+/-	08/97 -	
			A 4 / S 4 (94-) 2.8 i V6	AMX/APR/AQD	G	A	+/-	08/98 -	
			A 4 / S 4 (94-) 2.5 Tdi	AFB	D	A	+/-	11/97 -	
			A 4 / S 4 (94-) 2.5 Tdi	AKN	D	A	+/-	08/98 -	
			A 6 / S 6 (97-) 2.4 i V6	AML/AMM	G	A	+/-	06/00 - 05/01	
			A 6 / S 6 (97-) 2.8 i V6	ACK	G	A	+/-	04/97 - 01/99	
			A 6 / S 6 (97-) 2.8 i V6	AGE	G	A	+/-	10/97 - 05/00	
			A 6 / S 6 (97-) 2.8 i V6	ALG	G	A	+/-	06/97 - 01/99	
			A 6 / S 6 (97-) 2.8 i V6	AMX	G	A	+/-	06/00 - 04/01	
			A 6 / S 6 (01-) 2.4 i 30V	AMM	G	A	+/-	06/01 - 05/04	
			PASSAT (96-) 2.5 Tdi	AFB	D	A	+	08/98 - 08/00	
			PASSAT (96-) 2.5 Tdi	AKN	D	A	+	05/99 - 08/00	
			PASSAT (96-) 2.8 i V6	ACK	G	A	+/-	06/97 - 12/98	
			PASSAT (96-) 2.8 i V6	AGE	G	A	+/-	05/97 - 09/99	
PASSAT (96-) 2.8 i V6	ALG	G	A	+/-	06/97 - 08/00				
PASSAT (96-) 2.8 i V6	APR	G	A	+/-	01/99 - 08/00				
PASSAT (96-) 2.8 i V6	AQD/ATX	G	A	+/-	09/99 - 08/00				
AI0A496-917	8D0121251N	60497	AUDI A4 {A6 97-04/PASSAT 96-} РАДИАТОР ОХЛАЖДЕН						632 398 32
AI0A496-910	8D0121251N	60497A	AUDI A4 '96-00 РАДИАТОР ОХЛАЖДЕН (NISSENS)						632 398 32
			A 4 / S 4 (94-) 2.4 i V6	AFM	G	M	+/-	07/95 -	
			A 4 / S 4 (94-) 2.4 i V6	AGA/ALG/ALF	G	M	+/-	08/97 -	
			A 4 / S 4 (94-) 2.4 i V6	AMM	G	M	+/-	06/00 -	
			A 4 / S 4 (94-) 2.4 i V6	APS/APZ/ARJ/AML	G	M	+/-	08/98 -	
			A 4 / S 4 (94-) 2.6 i V6	ABC	G	M	+/-	11/94 -	
			A 4 / S 4 (94-) 2.6 i V6	ACZ	G	M	+/-	01/96 -	
			A 4 / S 4 (94-) 2.8 i V6	AAH	G	M	+/-	11/94 -	
			A 4 / S 4 (94-) 2.8 i V6	ACK	G	M	+/-	03/96 -	
			A 4 / S 4 (94-) 2.8 i V6	ALG	G	M	+/-	08/97 -	
			A 4 / S 4 (94-) 2.8 i V6	AMX/APR/AQD	G	M	+/-	08/98 -	
			A 4 / S 4 (94-) 2.8 i V6	ATX	G	M	+/-	03/99 -	

№ФОРВАРДА	№ OEM	№ NISSENS	МОДЕЛЬ	ТИП ДВИГАТЕЛЯ	БЕН/Д ИЗ	ТИП КП	КОНД ИЦИ	ГОД	ПРИМЕЧА НИЕ
			A 4 / S 4 (94-) 2.5 Tdi	AFB	D	M	+/-	11/97 -	
			A 4 / S 4 (94-) 2.5 Tdi	AKN	D	M	+/-	08/98 -	
			A 6 / S 6 (97-) 2.4 i V6	AGA/AJG/ALW/ALF	G	M	+/-	04/97 - 01/99	
			A 6 / S 6 (97-) 2.4 i V6	AML/AMM/ASM	G	M	+/-	06/00 - 05/01	
			A 6 / S 6 (97-) 2.4 i V6	APC	G	M	+/-	04/98 - 04/01	
			A 6 / S 6 (97-) 2.4 i V6	APS/APZ/ARJ	G	M	+/-	11/98 - 04/01	
			A 6 / S 6 (97-) 2.4 i V6	ARN	G	M	+/-	02/99 - 05/00	
			A 6 / S 6 (97-) 2.7 i V6 TURBO	AJK	G	M	+/-	02/99 - 08/00	
			A 6 / S 6 (97-) 2.7 i V6 TURBO	APB/AZA	G	M	+/-	09/00 - 04/01	
			A 6 / S 6 (97-) 2.8 i V6	ACK	G	M	+/-	04/97 - 01/99	
			A 6 / S 6 (97-) 2.8 i V6	AGE	G	M	+/-	10/97 - 05/00	
			A 6 / S 6 (97-) 2.8 i V6	ALG	G	M	+/-	06/97 - 01/99	
			A 6 / S 6 (97-) 2.8 i V6	AMX	G	M	+/-	06/00 - 04/01	
			A 6 / S 6 (97-) 2.8 i V6	APR/AQD	G	M	+/-	11/98 - 04/01	
			A 6 / S 6 (97-) 2.8 i V6	ATX	G	M	+/-	07/99 - 04/01	
			A 6 / S 6 (97-) 2.8 i V6	ATX	G	A	+/-	07/99 - 04/01	
			A 6 / S 6 (01-) 2.4 i 30V	AMM/ASM/BDV	G	M	+/-	06/01 - 05/04	
			A 6 / S 6 (01-) 2.7 i V6 TURBO	BEL	G	M	+/-	07/02 - 05/04	
			SUPERB (02-) 2.5 Tdi	AYM/AMX	D	M	+	12/01 -	
			SUPERB (02-) 2.5 Tdi	BDG	D	M	+	06/03 -	
			PASSAT (96-) 2.5 Tdi	AFB	D	M	+	08/98 - 08/00	
			PASSAT (96-) 2.5 Tdi	AKN	D	M	+	05/99 - 08/00	
			PASSAT (96-) 2.8 i V6	ACK/AGE/ALG	G	M	+/-	06/97 - 12/98	
			PASSAT (96-) 2.8 i V6	APR	G	M	+/-	01/99 - 08/00	
			PASSAT (96-) 2.8 i V6	AQD/ATX	G	M	+/-	09/99 - 08/00	
			PASSAT (00-) 2.5 Tdi	AKN/BAU	D	M	+/-	09/00 -	
			PASSAT (00-) 2.5 Tdi	BDG	D	M	+/-	05/03 -	
			PASSAT (00-) 2.5 Tdi	BDH	D	M	+/-	01/03 -	
			PASSAT (00-) 2.8 i V6	AMX/ATQ/BBG	G	M	+/-	09/00 -	
AI0A401-910	8E0121251L	60305A	AUDI A4 '01- РАДИАТОР ОХЛАЖДЕН (NISSENS)						632 399 26
AI0A401-913	8E0121251L	60305	AUDI A4 '01- РАДИАТОР ОХЛАЖДЕН						632 399 26

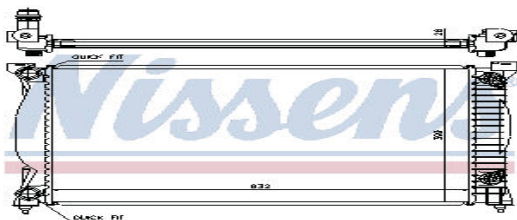

			A 4 / S 4 1.8 I 20V TURBO	AMB	G	A	+	07/01-	
			A 4 / S 4 1.8 I 20V TURBO	AVJ	G	A	+	12/00-06/02	
			A 4 / S 4 1.8 I 20V TURBO	BEX	G	A	+	11/02-	
			A 4 / S 4 1.8 I 20V TURBO	BFB	G	A	+	07/02 -05/03	
			A 4 / S 1.9 TDi	AVF	D	A	+	04/01-	
			A 4 / S 4 2.0 FSi	AWA	G	A	+	07/02-	
			A 4 / S 4 2.0 i 16V	ALT/BRE/BRF	G	A	+	12/00-	
			A 4 / S 4 2.0 PD TDi	BLB/BNA/BPW/BRC/BRC/BR	G	A	+	12/00-	
			A 4 / S 4 2.0 TFSi	BGB/BPG/BPJ/BUL/BWE/BW	G	A	+	12/00-	
			A 6 / S 6 2.0 i	ALT	G	A	+	06/01-05/04	

AI0A401-911	8E0121251/251A	60304A	AUDI A4 '01-РАДИАТОР 01- ОХЛАЖДЕН (NISSENS)						632 399 26
AI0A401-912	8E0121251/A	60304	AUDI A4 '01-РАДИАТОР ОХЛАЖДЕН						632 399 26

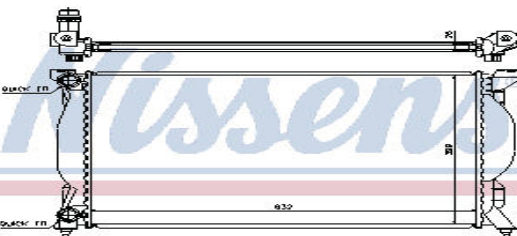



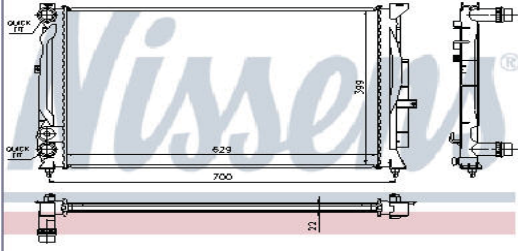

			A 4 / S 4 1.6 I 16V	ALZ	G	M	+	12/00-	
			A 4 / S 4 1.8 I 20V TURBO	AMB	G	M	+	07/01-	
			A 4 / S 4 1.8 I 20V TURBO	AVJ	G	M	+	12/00-06/02	
			A 4 / S 4 1.8 I 20V TURBO	BEX	G	M	+	11/02-	
			A 4 / S 4 1.8 I 20V TURBO	BFB	G	M	+	07/02-05/03	
			A 4 / S 4 1.9 TDi	AVB	D	M	+	04/01-05/04	
			A 4 / S 4 1.9 TDi	AVF	D	M	+	04/01-	
			A 4 / S 4 1.9 TDi	AWX	D	M	+	12/00-06/03	
			A 4 / S 4 1.9 TDi	BKE/BRB	D	M	+	06/04-	
			A 4 / S 4 2.0 FSi	AWA	G	M	+	07/02-	
			A 4 / S 4 2.0 i 16V	ALT/BRE/BRF	G	M	+	12/00-	
			A 4 / S 4 2.0 PD TDi	BLB/BNA/BPW/BRD/BVA/BV	D	M	+	12/00-	
			A 4 / S 4 2.0 TFSi	BGB/BPG/BPJ/BUL/BWE/BW	G	M	+	12/00-	
			A 6 / S 6 2.0 i	ALT	G	M	+	06/01-05/04	

№ ФОРВАРДА	№ OEM	№ NISSENS	МОДЕЛЬ	ТИП ДВИГАТЕЛЯ	БЕН/Д ИЗ	ТИП КП	КОНД ИЦИ	ГОД	ПРИМЕЧА НИЕ
A10A401-914	8D0121251BA/AT	60308	AUDI A4 '01- РАДИАТОР ОХЛАЖДЕН (NISSENS)						629 399 22
				A 4 / S 4 (94-) 1.6 i	ADP	G	M	+/-	11/94 -
				A 4 / S 4 (94-) 1.6 i	AHL	G	M	-	10/96 -
				A 4 / S 4 (94-) 1.6 i	ALZ	G	M	-	06/00 -
				A 4 / S 4 (94-) 1.6 i	ANA/ARM	G	M	-	08/98 -
				A 4 / S 4 (94-) 1.8 i 20V	ADR	G	M	-	11/94 -
				A 4 / S 4 (94-) 1.8 i 20V	AFY	G	M	-	07/95 -
				A 4 / S 4 (94-) 1.8 i 20V	APT	G	M	-	04/99 -
				A 4 / S 4 (94-) 1.8 i 20V	ARG	G	M	-	08/98 -
				A 4 / S 4 (94-) 1.8 i 20V	AVV	G	M	-	06/00 -
				A 4 / S 4 (94-) 1.8 i TURBO 20V	AEB	G	M	-	10/95 -
				A 4 / S 4 (94-) 1.8 i TURBO 20V	AJL	G	M	-	08/97 -
				A 4 / S 4 (94-) 1.8 i TURBO 20V	ANB	G	M	-	01/99 -
				A 4 / S 4 (94-) 1.8 i TURBO 20V	APU/ARK	G	M	-	04/98 -
				A 4 / S 4 (94-) 1.8 i TURBO 20V	AWT	G	M	-	06/00 -
				A 4 / S 4 (94-) 1.9 Tdi	AFF/AFN/AHU	D	M	-	03/96 -
				A 4 / S 4 (94-) 1.9 Tdi	AJM	D	M	-	08/98 -
				A 4 / S 4 (94-) 1.9 Tdi	ATJ/AVG	D	M	-	08/99 -
				A 4 / S 4 (94-) 1.9 Tdi	IZ	D	M	-	01/95 -
				A 6 / S 6 (97-) 1.8 i 20V	AFY	G	M	-	05/97 - 05/00
				A 6 / S 6 (97-) 1.8 i 20V	AJP	G	M	-	12/97 - 07/99
				A 6 / S 6 (97-) 1.8 i 20V	AQE/ARH	G	M	-	01/99 - 04/01
				A 6 / S 6 (97-) 1.8 i 20V TURBO	AEB	G	M	-	04/97 - 01/99
				A 6 / S 6 (97-) 1.8 i 20V TURBO	AJL	G	M	-	11/97 - 10/00
				A 6 / S 6 (97-) 1.8 i 20V TURBO	ANB/ARK	G	M	-	01/99 - 09/00
				A 6 / S 6 (97-) 1.8 i 20V TURBO	APU	G	M	-	11/98 - 04/01
				A 6 / S 6 (97-) 1.8 i 20V TURBO	AWT	G	M	-	05/00 - 04/01
				A 6 / S 6 (97-) 1.9 Tdi	AFN	D	M	-	04/97 - 04/01
				A 6 / S 6 (97-) 1.9 Tdi	AJM	D	M	-	01/98 - 04/01
				SUPERB (02-) 1.9 Tdi	AVB/AVF/BPZ/BSV	D	M	-	06/02 -
				SUPERB (02-) 1.9 Tdi	AWX	D	M	-	12/01 -
				SUPERB (02-) 2.0 i	AZM	G	M	+/-	12/01 -
				SUPERB (02-) 2.0 i 16V	BSS	G	M	+/-	12/01 -
				PASSAT (96-) 1.6 i	ADP	G	M	-	01/97 - 10/97
				PASSAT (96-) 1.6 i	AHL	G	M	-	10/96 - 08/00
				PASSAT (96-) 1.6 i	ANA/ARM	G	M	-	07/99 - 08/00
				PASSAT (96-) 1.8 i	ADR	G	M	-	12/96 - 01/99
				PASSAT (96-) 1.8 i	AFY	G	M	-	01/97 - 04/00
				PASSAT (96-) 1.8 i	APT/ARG	G	M	-	01/99 - 08/00
				PASSAT (96-) 1.8 i 20V TURBO	AEB	G	M	-	10/96 - 12/98
				PASSAT (96-) 1.8 i 20V TURBO	ANB/APU	G	M	-	01/99 - 08/00
PASSAT (96-) 1.9 Tdi	AFN/AHU	D	M	-	10/96 - 08/99				
PASSAT (96-) 1.9 Tdi	AHH	D	M	-	05/98 - 08/00				
PASSAT (96-) 1.9 Tdi	AJM	D	M	-	01/99 - 12/99				
PASSAT (96-) 1.9 Tdi	ATJ	D	M	-	01/00 - 08/00				
PASSAT (96-) 1.9 Tdi	AVG	D	M	-	08/99 - 08/00				
PASSAT (00-) 1.6 i	ALZ	G	M	-	09/00 -				
PASSAT (00-) 1.8 i 20V TURBO	AWM/AWT	G	M	-	09/00 -				
PASSAT (00-) 1.9 Tdi	AVB/AVF/AWX	D	M	-	09/00 -				
PASSAT (00-) 2.0 i	AZM	G	M	-	09/00 -				
PASSAT (00-) 2.0 i 16V	ALT	G	M	-	09/00 -				
PASSAT (00-) 2.0 Tdi	BGW	D	M	-	11/03 -				

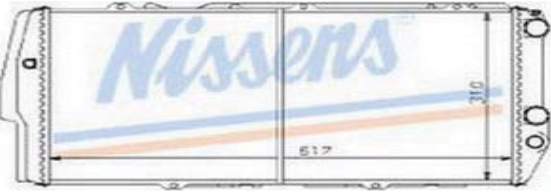
№ФОРВАРДА	№ OEM	№ NISSENS	МОДЕЛЬ	ТИП ДВИГАТЕЛЯ	БЕН/Д ИЗ	ТИП КП	КОНД ИЦИ	ГОД	ПРИМЕЧА НИЕ
AI10076-910	431121251A/C/K/L/M/R/T/433J/443HJMP	60455	AUDI 100 '76-90 {200 79-88} РАДИАТОР ОХЛАЖДЕН (NISSENS)						570 308 42
AI10076-911	431121251A/C/K/L/M/R/T/433J/443HJMP	60455	AUDI 100 '76-90 {200 79-88} РАДИАТОР ОХЛАЖДЕН						570 308 42
			100 AVANT 1,6 L/GL	1588YV	G	M		8/81-8/82	
			100 AVANT 1,9 L5/CL5/GL5/C5S/G	1871WH	G	M	*/-	8/80-8/82	
			100 AVANT 2,0 L5D/CL5D/GL5D/CD	1986CN	D	M		10/78-8/82	
			100 AVANT 2,0 LS/GLS	1994WA	G	M		9/77-7/78	
			100 AVANT 2,1 L5E/CL5E/GL5E/CD	2144WC	G	M	*/-	9/77-8/82	
			100 AVANT 2,1 L5E/CL5E/GL5E/CD	2144WB	G	M	*/-	4/78-8/82	
			100 AVANT Q 2,2 QUATTRO CS	2226PX	G	M		8/85-7/86	
			100 AVANT Q 2,2 QUATTRO CS	2226KU	G	M		10/84-11/88	
			100 AVANT Q 2,2 QUATTRO CS	2309NF	G	M		8/86-11/88	
			100 II 1,6 GL/C/CL/L/CS	1588YV	G	M	*/-	8/81-8/82	
			100 II 2,0 L5D/C5D/CL5D/GL5	1986CN	D	M		10/78-8/82	
			100 II 2,0 S/LS/GLS	1994WA	G	M		6/76-7/78	
			100 II 2,1 5E/L5E/GL5E/C5E	2100WC	G	M	*/-	3/77-8/82	
			100 II 2,1 5S/C5S/L5S/CL5/G	2100WB	G	M	*/-	4/78-8/82	
			100 III 1,9 CS/CD/CC	1871WH	G	M		9/82-7/84	
			100 III 2,0 CS/CD/CC	1994SL	G	MA		2/86-12/87	
			100 III 2,0 CS/CD/CC	1994KP	G	MA		9/84-12/84	
			100 III 2,0 CS/CD/CC	1994KP/RT	G	MA		12/84-12/90	
			100 III 2,0 DIESEL CS/CD/CC	1986CN	D	M		9/82-7/89	
			100 III 2,1 CS/CD/CC	2100KF/WC	G	M		8/82-7/84	
			100 III 2,1 CS/CD/CC	2100KF/WC	G	M	*	1/84-7/84	
			100 III 2,2 CS/CD/CC	2226KU	G	M		8/83-11/90	
			100 III 2,2 CS/CD/CC	2226KZ	G	M		8/84-9/86	
			100 III 2,3 CS/CD/CC	2309NF	G	M		1/87-12/90	
			100 QUATTRO 2,2 QUATTRO CS	2226PX	G	M		8/85-7/86	
			100 QUATTRO 2,2 QUATTRO CS	2226KU	G	M		10/84-11/88	
			100 QUATTRO 2,3 QUATTRO CS	2309NF	G	M		8/86-11/88	
			200 2,1 5E	2144WC	G	M		9/79-8/83	
			200 2,1 5E TURBO	2144WJ	G	M		9/79-8/83	
			200 AVANT Q 2,1 QUATTRO	2144KG	G	M		12/84-1/88	
			200 II 2,1	2144WC	G	M		12/84-7/85	
			200 II 2,1 TURBO	2144KH	G	M		1/84-7/85	
			200 II 2,1 TURBO	2144KG	G	M		8/83-1/88	
			200 II 2,2	2226WB	G	M		9/84-7/86	
			200 II 2,2	2226KU	G	M		9/84-1/88	
			200 QUATTRO 2,1 QUATTRO	2144KG	G	M		9/84-1/88	
AI10082-910	443121253C/A	60420	AUDI 100 '82-90 РАДИАТОР ОХЛАЖДЕН (NISSENS)						660 270 38
AI10082-913	443121253C/A	604201	AUDI 100 '82-90 РАДИАТОР ОХЛАЖДЕН						660 270 38
			100 AVANTO Q 1,8 QUATTRO CS	1781NP/PH/4B	G	M		10/84-12/90	
			100 AVANTO Q 1,8 QUATTRO CS	1781SH	G	M		2/86-7/88	
			100 III 1,8 CC	DR/RS	G	M		2/83-12/87	
			100 III 1,8 CS/CD/CC	1781SH	G	M		2/86-12/90	
			100 III 1,8 CS/CD/CC	1781DS	G	M		9/83-12/84	
			100 III 1,8 CS/CD/CC	1781DR	G	M		12/84-7/88	
			100 III 1,8 CS/CD/CC	1781PH	G	M		12/84-12/90	
			100 III 1,8 CS/CD/CC	1781DR	G	M		9/82-12/84	
			100 QUATTRO 1,8 QUATTRO CS	1781SH	G	M		2/86-7/88	
			100 QUATTRO 1,8 QUATTRO CS/CC/CD	1781NP/PH/4B	G	M		10/84-12/90	



№ФОРВАРДА	№ OEM	№ NISSENS	МОДЕЛЬ	ТИП ДВИГАТЕЛЯ	БЕН/Д ИЗ	ТИП КП	КОНД ИЦИ	ГОД	ПРИМЕЧА НИЕ
АП10082-911	447121251/L/1/443121251K/L	60478	AUDI 100 '82-90 РАДИАТОР ОХЛАЖДЕН (NISSENS)						617 310 42
АП10082-912	447121251/L/1/443121251K/L	60478	AUDI 100 '82-90 РАДИАТОР ОХЛАЖДЕН						617 310 42
			100 AVANT 2,3 QUATTRO	2309NF	G	M	*/-	8/89-12/90	
			100 AVANT Q 2,2 QUATTRO	2226KU	G	M	*/-	8/89-12/90	
			100 AVANT Q 2,2 QUATTRO	2226MC	G	M		8/89-12/90	
			100 AVANT Q 2,2 QUATTRO CS	2226KU	G	M	*/-	11/88-7/89	
			100 AVANT Q 2,2 QUATTRO CS	2226KU	G	M	*	10/84-11/88	
			100 AVANT Q 2,2 TURBO QUATTRO	2226MC	G	M		3/86-7/89	
			100 AVANT Q 2,3 QUATTRO	2309AAR	G	M	*/-	11/88-12/90	
			100 AVANT Q 2,3 QUATTRO CS	2309NF	G	M	*/-	11/88-7/89	
			100 III 2,0 TURBO DIESEL CS	1986NC	D	M		3/88-11/90	
			100 III 2,1 CS/CD/CC	2100KF/WC	G	M	*	8/82-1/84	
			100 III 2,2 CS/CD/CC	2226KZ	G	M	*	8/84-9/86	
			100 III 2,2 CS/CD/CC	2226KU	G	M	*	8/84-11/90	
			100 III 2,2 TURBO CS	2226MC	G	M		4/86-12/90	
			100 III 2,2 TURBO CS	2226 2B/1B	G	M		1/88-12/90	
			100 III 2,3 CS/CD/CC	2309NF	G	M	*	1/87-12/90	
			100 QUATTRO 2,2 QUATTRO	2226KU	G	M	*/-	8/89-12/90	
			100 QUATTRO 2,2 QUATTRO CS	2226KU	G	M	*/-	11/88-7/89	
			100 QUATTRO 2,2 QUATTRO TURBO	2226MC	G	M		3/86-12/90	
			100 QUATTRO 2,3 QUATTRO	2309NF	G	M	*/-	4/89-12/90	
			100 QUATTRO 2,3 QUATTRO CS	2309NF	G	M	*/-	11/88-3/89	
			200 AVANT Q 2,2 QUATTRO TURBO	2226MC	G	M		1/85-12/90	
			200 AVANT Q 2,2 QUATTRO TURBO	2226 1B	G	M		2/88-12/90	
			200 AVANT Q 2,3 QUATTRO	2309NF	G	M	*/-	8/89-12/90	
			200 II 2,2 TURBO	2226 2B/1B	G	M		2/88-12/90	
			200 II 2,3	2309NF	G	M	*/-	8/89-12/90	
			200 QUATTRO 2,2 QUATTRO TURBO	2226MC	G	M		1/85-12/90	
			200 QUATTRO 2,2 QUATTRO TURBO	2226 1B	G	M		2/88-12/90	
АП10090-910	4AO121251A/D/E/N	60457	AUDI 100 '90-94 {A6 94-} РАДИАТОР ОХЛАЖДЕН (NISSENS)						632 414 32
АП10090-913	4AO121251A/D/E/N	60457	AUDI 100 '90-94 {A6 94-} РАДИАТОР ОХЛАЖДЕН						632 414 32
			100 IV 2,3 E	2309AAR	G	M	*	12/90-7/94	
			100 IV 2,4 DIESEL	2370AAS	D	M	*	12/90-7/94	
			100 IV 2,5 TURBO DIESEL TDI	2460AAT/ABP	D	M	*	12/90-7/94	
			100 QUATTRO 2,3 QUATTRO	2309AAR	G	M		1/90-12/90	
			A6 1,8 20V	1781ADR	G	M	*/-	1/96-	
			A6 1,9 TDI	1896	D	M	*	7/94-	
			A6 2,0	1984ACE	G	M	*	7/94-	
			A6 2,5 TDI	2460	D	M	*	7/94-	
АП10090-911	4AO121251L/Q/K	60459A	AUDI 100 '90-94 {A6 94-} РАДИАТОР ОХЛАЖДЕН (NISSENS)						632 414 32
АП10090-912	4AO121251L/Q/K	60459A	AUDI 100 '90-94 {A6 94-} РАДИАТОР ОХЛАЖДЕН						632 414 32
			100 AVANT C4 2,6 E	2598ABC	G	M		7/92-6/94	
			100 AVANT C4 2,8 E	2771AAH	G	M	*/-	10/91-6/94	
			100 AVANT Q 2,6 QUATTRO	2598ABC	G	M	*/-	3/92-6/94	
			100 AVANT Q 2,8 QUATTRO	2771AAH	G	M	*/-	8/91-6/94	
			100 IV 2,6 E	2598ABC	G	M	*/-	3/92-7/94	
			100 IV 2,8 E	2771AAH	G	M	*/-	1/92-7/94	
			100 QUATTRO 2,6 QUATTRO	2598ABC	G	M	*/-	3/92-6/94	
			100 QUATTRO 2,8 QUATTRO E	2771AAH	G	M	*/-	12/90-6/94	
			A6 2,6 V6	2598ABC	G	M	*/-	7/94-	
			A6 2,8 V6	2771AAH	G	M	*/-	7/94-	

№ФОРВАРДА	№ OEM	№ NISSENS	МОДЕЛЬ	ТИП ДВИГАТЕЛЯ	БЕН/Д ИЗ	ТИП КП	КОНД ИЦИ	ГОД	ПРИМЕЧА НИЕ
AI10091-912	4A0121251/E	60460A	AUDI 100 '91-94 {A6 94-} РАДИАТОР ОХЛАЖДЕН (NISSENS)						632 414 22
			100 AVANT C4 2,0	1984AAE	G	M	*/-	10/91-6/94	
			100 AVANT C4 2,0 16V	1994ACE	G	M	*	12/90-6/94	
			100 AVANT C4 2,0 E	1994AAD	G	M	*/-	10/91-12/92	
			100 AVANT C4 2,3 E	2309AAR	G	M	*/-	10/91-6/94	
			100 AVANT C4 2,4 DIESEL	2370AAS	D	M	*/-	10/91-6/94	
			100 AVANT C4 2,5 TURBO DIESEL TDI	2460AAT	D	M	*/-	10/91-6/94	
			100 AVANT Q 2,0 QUATTRO	1984ACE	G	M		8/92-6/94	
			100 AVANT Q 2,0 QUATTRO	1984AAD	G	M	*/-	10/91-6/94	
			100 AVANT Q 2,2 S4	2226AAN	G	M		10/91-6/94	
			100 AVANT Q 2,3 QUATTRO	2309AAR	G	M	*/-	10/91-6/94	
			100 IV 2,0 16V	1984ACE	G	M		1/92-7/94	
			100 IV 2,3 E	2309AAR	G	M		12/90-7/94	
			100 IV 2,5 TURBO DIESEL TDI	2460AAT/ABP	D	M		12/90-7/94	
			100 QUATTRO 2,0 QUATTRO	1994ACE	G	M	*/-	8/92-6/94	
			100 QUATTRO 2,0 QUATTRO	1994AAD	G	M		1/91-6/94	
			100 QUATTRO 2,2 S4	2226AAN	G	M		9/91-6/94	
			100 QUATTRO 2,3 QUATTRO E	2309AAR	G	M	*/-	12/90-6/94	
			100AVANT Q 2,3 QUATTRO	2309AAR	G	M	*/-	1/90-12/90	
			100IV 2,4 DIESEL	2370AAS	D	M		12/90-7/94	
			200 AVANT Q 2,3 QUATTRO	2309AAR	G	M		1/90-12/90	
			200 II 2,3	2309AAR	G	M		1/90-12/90	
			200 QUATTRO 2,3 QUATTRO	2309AAR	G	M		1/90-12/90	
			A6 1,9 TDI	1896 1Z	D	M		7/94-	
			A6 2,0	1984ACE	G	M		7/94-	
			A6 2,5 TDI	2460	D	M		7/94-	
COUPE II 2,3	2309AAR	G	M		8/90-				
COUPE Q 2,3 QUATTRO	2309AAR	G	M		9/90-				

AI10091-913	4A0121251C	60477A	AUDI 100 '91-94 {A6 94-} РАДИАТОР ОХЛАЖДЕНИЯ (NISSENS)						632 409 26
AI10091-914	4A0121251C/F	60477	AUDI 100 {A6 94-} РАДИАТОР ОХЛАЖДЕН						632 409 26

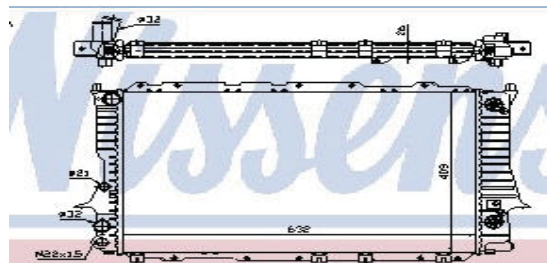

AUDI 100 2,0 E	1984AAD	G	A	*/-	12/90-12/92
AUDI 100 2,0 E	1984AAD	G	A	*/-	12/90-12/92
AUDI 100 2,0 E	1984ABK	G	A	*/-	1/93-7/94
AUDI 100 2,0 E	1984ABK	G	A	*/-	1/93-7/94
AUDI 100 2,0 E	1984ADW	G	A	*/-	12/93-7/94
AUDI 100 2,2 S 4	2226AAN	G	A	*/-	8/91-7/94
AUDI 100 2,3 E	2309AAR	G	A	*/-	12/90-7/94
AUDI 100 2,3 E	2309AAR	G	A	*/-	12/90-7/94
AUDI 100 2,5 TDI	2460AAT	D	A	*/-	12/90-7/94
AUDI 100 2,5 TDI	2460AAT	D	A	*/-	12/90-7/94
AUDI 100 2,5 TDI	2460ABP	D	A	*/-	8/91-7/92
AUDI 100 2,5 TDI	2460ABP	D	A	*/-	8/91-7/92
AUDI A6 1,8 20V	1781ADR	G	A	*/-	10/95-6/96
AUDI A6 1,8 20V	1781ADR	G	A	*/-	10/95-6/96
AUDI A6 1,8 20V	1781ADR	G	A	*/-	7/96-10/97
AUDI A6 1,8 20V	1781ADR	G	A	*/-	7/96-10/97
AUDI A6 1,9 TDI	1896AHU	D	A	*/-	8/96-7/98
AUDI A6 1,9 TDI	1896AHU	D	A	*/-	8/96-7/98
AUDI A6 1,9 TDI	18961Z	D	A	*/-	7/95-6/96
AUDI A6 1,9 TDI	18961Z	D	A	*/-	7/95-6/96
AUDI A6 1,9 TDI	18961Z	D	A	*/-	7/94-7/95
AUDI A6 1,9 TDI	18961Z	D	A	*/-	7/94-7/95
AUDI A6 1,9 TDI	1896AHU	D	A	*/-	7/96-10/97
AUDI A6 1,9 TDI	1896AHU	D	A	*/-	7/96-10/97
AUDI A6 2,0	1984AAE	G	A	*/-	7/95-6/96
AUDI A6 2,0	1984AAE	G	A	*/-	7/95-6/96
AUDI A6 2,0	1984ABK	G	A	*/-	7/95-6/96
AUDI A6 2,0	1984ABK	G	A	*/-	7/95-6/96
AUDI A6 2,0	1984ABK	G	A	*/-	6/94-5/97
AUDI A6 2,0	1984ABK	G	A	*/-	6/94-5/97
AUDI A6 2,0	1984ADW	G	A	*/-	7/95-6/96
AUDI A6 2,0	1984ADW	G	A	*/-	7/95-6/96
AUDI A6 2,0	1984ADW	G	A	*/-	7/9610/97

№ФОРВАРДА	№ OEM	№ NISSENS	МОДЕЛЬ	ТИП ДВИГАТЕЛЯ	БЕН/Д ИЗ	ТИП КП	КОНД ИЦИ	ГОД	ПРИМЕЧА НИЕ
		AUDI A6 2,0		1984ADW	G	A	*/-	7/9610/97	
		AUDI A6 2,2		2226ANN	G	A	*/-	7/96-7/97	
		AUDI A6 2,3 20V		AAR	G	A	*/-	6/94-7/95	
		AUDI A6 2,3 20V		AAR	G	A	*/-	6/94-7/95	
		AUDI A6 2,5 TDI		2460AAT	D	A	*/-	7/95-6/96	
		AUDI A6 2,5 TDI		2460AAT	D	A	*/-	7/95-6/96	
		AUDI A6 2,5 TDI		2460AAT	D	A	*/-	7/96-10/97	
		AUDI A6 2,5 TDI		2460AAT	D	A	*/-	7/96-10/97	
		AUDI A6 2,5 TDI		2460AAT	D	A	*/-	6/94-7/95	
		AUDI A6 2,5 TDI		2460AAT	D	A	*/-	6/94-7/95	
		AUDI A6 2,5 TDI		2460AEL	D	A	*/-	7/95-6/96	
		AUDI A6 2,5 TDI		2460AEL	D	A	*/-	7/95-6/96	
		AUDI A6 2,5 TDI		2460AEL	D	A	*/-	7/96-10/97	

ВМ0Х500-911 1439101 60787 X5 '00- РАДИАТОР ОХЛАЖДЕНИЯ (NISSENS) 590 598 40

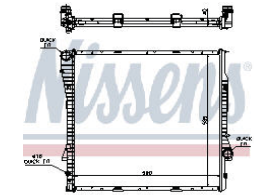

BMW X5 E 53 3,0D	2926 M57N	D	M/A	*/-	04/10-
BMW X5 E 53 4,4i	4398	G	A	*/-	03/10-
BMW X5 E 53 4,6i	4398	G	M/A	*/-	00/9-04/3
BMW X5 E 53 4,8i	4398	G	M/A	*/-	00/9-

ВМЕ3082-910 1151700/1152070/752 60678 E30 '82-87 {E28 80-84} РАДИАТОР ОХЛАЖДЕН (NISSENS) 350 443 33







E28 518	M10	G	M		11/80-9/84
E28 518i	M10	G	M		11/80-9/84
E30 2 DOORS 316	M10	G	M		9/82-9/87
E30 2 DOORS 316i M10	M10	G	M		9/87-6/88
E30 2 DOORS 318i M10	M10	G	M		9/82-9/87
E30 4 DOORS 316	M10	G	M		/83-9/87
E30 4 DOORS 316i M10	M10	G	M		9/87-6/88
E30 4 DOORS 318i M10	M10	G	M		/83-9/87





ВМЕ3085-910 1719260/2242313/1468078/1728908/1469179 60619A E30 '85-93 {E36 93-96} РАДИАТОР ОХЛАЖДЕН (NISSENS) 550 438 32

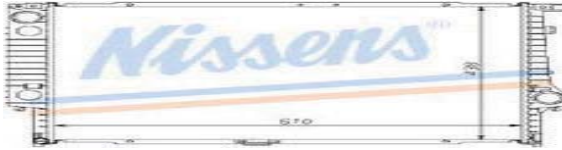
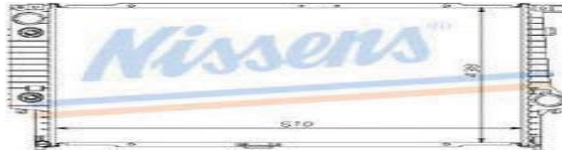

E30 4 DOORS 324 d	M21D24	D	M	*/-	9/87-11/90
E30 4 DOORS 324 d	M21D24	D	M	*/-	4/85-9/87
E30 4 DOORS 324 td	M21	D	M	*/-	4/87-11/90
E30 TOURING 324 td	M21	D	M	*	9/87-11/93
E30 TOURING 324 td	M21	D	M		9/87-11/93
E36 325 iT	M50	G	MA		/93-/96

№ФОРВАРДА	№ OEM	№ NISSENS	МОДЕЛЬ	ТИП ДВИГАТЕЛЯ	БЕН/Д ИЗ	ТИП КП	КОНД ИЦИ	ГОД	ПРИМЕЧА НИЕ		
ВМЕ3087-910	2241913/1719261/1468079/1723825	60618A	E30 '87-93 {E32 91-94/E34 92-93} РАДИАТОР ОХЛАЖДЕН (NISSENS)						550 438 32		
			E30 4 DOORS 324 d	M21D24	D	A	*/-	9/87-11/90			
			E30 4 DOORS 324 d	M21D24	D	A	*/-	4/85-9/87			
			E30 4 DOORS 324 td	M21	D	A	*/-	4/87-11/90			
			E30 TOURING 324 td	M21	D	A	*	9/87-11/93			
			E30 TOURING 324 td	M21	D	A		9/87-11/93			
			E32 730 i M60	M60	G	A		3/91-5/94			
			E32 730 iL M60	M60	G	A		3/91-5/94			
			E34 530 i M60	M60	G	A		3/92-9/93			
			E34 TOURING 530 i	M60	G	A		3/92-9/93			
ВМЕ3087-911	1719256/1712256	60797A	E30 '87-93 РАДИАТОР ОХЛАЖДЕН (NISSENS)					440 328 32			
ВМЕ3087-915	1719256/1712256	60797	E30 '87-93 РАДИАТОР ОХЛАЖДЕН					440 329 32			
			E30 4 DOORS 320 i	M20	G	M		9/87-12/90			
			E30 4 DOORS 325 i	M20	G	M		9/87-11/90			
			E30 4 DOORS 325 ix	M20	G	M		9/87-11/90			
			E30 CABRIO 320 i	M20	G	M		9/87-11/93			
			E30 CABRIO 325 i	M20	G	M		9/87-11/92			
			E30 TOURING 320 i	M20	G	M		9/87-12/90			
			E30 TOURING 325 i	M20	G	M		9/87-11/93			
			E30 TOURING 325 ix	M20	G	M		9/87-3/92			
			ВМЕ3087-912	1719024/300	60729A	E30 '87-93 РАДИАТОР ОХЛАЖДЕН (NISSENS)					380 328 32
ВМЕ3087-917	1719024/300	60729	E30 '87-93 РАДИАТОР ОХЛАЖДЕН					380 329 32			
			E30 2 DOORS 316 i M40	M40	G	M		6/88-10/91			
			E30 2 DOORS 318 i M40	M40	G	M		9/87-11/91			
			E30 4 DOORS 316 i M40	M40	G	M		6/88-10/90			
			E30 4 DOORS 318i M40	M40	G	M		9/87-11/91			
			E30 CABRIO 318 i	M40	G	M		/90-11/93			
			E30 TOURING 316 i	M40	G	M		6/91-1/95			
			E30 TOURING 318 i	M40	G	M		8/90-1/95			
			ВМЕ3087-913	1719301	60731A	E30 '87-93 РАДИАТОР ОХЛАЖДЕН (NISSENS)					380 328 32
			ВМЕ3087-918	1719301	60731	E30 '87-93 РАДИАТОР ОХЛАЖДЕН					380 329 32
			E30 2 DOORS 316 i M40	M40	G	A		6/88-10/91			
			E30 2 DOORS 318 i M40	M40	G	A		9/87-11/91			
			E30 4 DOORS 316 i M40	M40	G	A		6/88-10/90			
			E30 4 DOORS 318i M40	M40	G	A		9/87-11/91			
			E30 CABRIO 318 i	M40	G	A		/90-11/93			
			E30 TOURING 316 i	M40	G	A		6/91-1/95			
			E30 TOURING 318 i	M40	G	A		8/90-1/95			

№ФОРВАРДА	№ OEM	№ NISSENS	МОДЕЛЬ	ТИП ДВИГАТЕЛЯ	БЕН/Д ИЗ	ТИП КП	КОНД ИЦИ	ГОД	ПРИМЕЧА НИЕ
ВМЕ3087-914	1719303/305	60703A	E30 '87-91 {E34 88-92} РАДИАТОР ОХЛАЖДЕН (NISSENS)						440 328 32
ВМЕ3087-916	1719303/305	60703	E30 '87-91 {E34 88-92} РАДИАТОР ОХЛАЖДЕН						440 329 32
			E30 2 DOORS 316 i M40	M40	G	A	*	6/88-10/91	
			E30 2 DOORS 318 i M40	M40	G	A	*	9/87-11/91	
			E30 4 DOORS 316 i M40	M40	G	A	*	6/88-10/90	
			E30 4 DOORS 318 i M40	M40	G	A	*	9/87-11/91	
			E30 CABRIO 318 i	M40	G	A	*	/90-11/93	
			E30 TOURING 316 i	M40	G	A	*	6/91-1/95	
			E30 TOURING 318 i	M40	G	A	*	8/90-1/95	
			E34 520 i M20	M20	G	A	*	6/88-/90	
			E34 520 i M20	M20	G	A	*	6/87-6/88	
			E34 520 i M50	M50	G	A	*	9/89-9/92	
			E34 525 i M20	M20	G	A	*	6/87-6/88	
			E34 525 i M20	M20	G	A	*	6/88-8/90	
			E34 525 i M50	M50	G	A	*	9/89-9/92	
			E34 525 ix	M50	G	A	*	4/91-9/92	
E34 TOURING 520 i	M50	G	A	*	11/90-9/92				
E34 TOURING 525 i	M50	G	A	*	12/90-9/92				
E34 TOURING 525 ix	M50	G	A	*	7/91-9/92				
ВМЕ3285-915	1723689/2226336/1468085/082	60596A	E32 '85-94 {E34 87-96} РАДИАТОР ОХЛАЖДЕН						610 438 40
ВМЕ3285-910	1723689/2226336/1468085/082	60596A	E32 '85-94 {E34 87-96} РАДИАТОР ОХЛАЖДЕН (NISSENS)						610 438 40
			E32 735 i L	M30	G	M	*	10/85-2/92	
			E34 530 i M30	M30	G	M	*	6/87-/90	
			E34 535 i	M30	G	M	*	3/87-/93	
			E34 M5 3,6	S38	G	MA	*/-	4/88-6/92	
			E34 M5 3,8	S38	G	MA	*/-	1/91-5/95	
			E34 TOURING M5	S38	G	M	*/-	/92-/96	
ВМЕ3285-911	1723467/1468080/1709459	60597A	E32 '85-94 {E34 87-93} РАДИАТОР ОХЛАЖДЕН (NISSENS)						610 438 40
			E32 735 i L	M30	G	A	*	10/85-2/92	
			E34 530 i M30	M30	G	A	*	6/87-6/88	
			E34 530 i M30	M30	G	A	*	6/88-/90	
			E34 535 i	M30	G	A	*	6/88-/93	
			E34 535 i	M30	G	A	*	3/87-6/88	
ВМЕ3285-912	1712005	60742	E32 '85-94 РАДИАТОР ОХЛАЖДЕН (NISSENS)						470 330 33
			E32 730 i M30	M30	G	M	*	7/86-7/94	
			E32 735 i	M30	G	M	*	10/85-/87	
			E32 735 i L	M30	G	M	*	/87-/92	

№ФОРВАРДА	№ OEM	№ NISSENS	МОДЕЛЬ	ТИП ДВИГАТЕЛЯ	БЕН/Д ИЗ	ТИП КП	КОНД ИЦИ	ГОД	ПРИМЕЧА НИЕ	
	1723365/1712365	60642A	E32 '85-94 {E34 87-93} РАДИАТОР ОХЛАЖДЕН (NISSENS)						548 328 42	
			E32 730 i L M30	M30	G	A	6/86-7/94			
			E32 730 i M30	M30	G	A	7/86-7/94			
			E32 735 i	M30	G	A	10/85-2/92			
			E32 735 i L	M30	G	A	10/85-2/92			
			E34 530 i M30	M30	G	A	6/87-6/88			
			E34 530 i M30	M30	G	A	6/88-9/90			
			E34 535 i	M30	G	A	3/87-6/88			
			E34 535 i	M30	G	A	6/88-9/93			
	1712007	60744A	E32 '85-94 {E34 87-93} РАДИАТОР ОХЛАЖДЕН (NISSENS)						548 328 33	
			BMW Z1 2.5 ROADSTER	M20	G	M	10/88-6/91			
			E32 730 i L M30	M30	G	M	6/86-7/94			
			E32 730 i M30	M30	G	M	7/86-7/94	КАТ		
			E32 735 i	M30	G	M	10/85-2/92	КАТ		
			E32 735 i L	M30	G	M	10/85-2/92	КАТ		
			E34 530 i M30	M30	G	M	6/87-7/90			
			E34 535 i	M30	G	M	3/87-9/93			
	1723468/398/1468081/1712265/267	60748A	E32 '86-94 {E34 87-93} РАДИАТОР ОХЛАЖДЕН						650 438 42	
			E32 '86-94 {E34 87-93} РАДИАТОР ОХЛАЖДЕН (NISSENS)							650 438 42
				E31 850 CS i	M70	G	A	10/92-10/96		
				E31 850 i	M70	G	A	11/89-12/94		
				E32 730 i L M60	M60	G	A	3/91-5/94	*	
				E32 730 i M60	M60	G	A	3/91-5/94	*	
				E32 750 i	M70	G	A	9/86-5/94	*/-	
				E32 750 i L	M70	G	A	9/86-5/94	*	
				E34 524 td	M21	D	A	7/87-8/91	*/-	
				E34 530 i M60	M60	G	A	3/92-9/93	*	
E34 TOURING 530 i	M60	G		A	3/92-9/93	*				
	2242138/2243445	60747A	E32 '91-94 {E34 87-96} РАДИАТОР ОХЛАЖДЕН (NISSENS)						650 438 42	
			E32 '91-94 {E34 87-96} РАДИАТОР ОХЛАЖДЕН (NISSENS)							650 438 42
				E31 850 CS i	M70	G	M	10/92-10/96		
				E31 850 i	M70	G	M	11/89-12/94		
				E32 730 i L M60	M60	G	M	3/91-5/94	*	
				E32 730 i M60	M60	G	M	3/91-5/94	*	
				E32 740 i	M60	G	MA	9/91-5/94	*	
				E32 740 i L	M60	G	MA	9/91-5/94	*	
				E34 524 td	M21	D	M	7/87-8/91	*/-	
				E34 525 td	M51	D	MA	9/92-9/95	*/-	
				E34 530 i M60	M60	G	M	3/92-6/94	*	
				E34 540 i	M60	G	MA	9/92-9/95	*	
				E34 TOURING 525 td	M51	D	MA	9/92-9/96	*/-	
				E34 TOURING 530 i	M60	G	M	3/92-6/94	*	
				E34 TOURING 540 i	M60	G	MA	9/93-9/96	*	
	1719302/304/1712982/1723537	60735A		E34 '87-95 {E30/E36} РАДИАТОР ОХЛАЖДЕН (NISSENS)						440 328 32
			E34 '87-95 {E30/E36} РАДИАТОР ОХЛАЖДЕН (NISSENS)							440 328 32
				E30 2 DOORS 316 i M40	M40	G	M	6/88-10/91	*	
				E30 2 DOORS 318 i M40	M40	G	M	9/87-11/91	*	
				E30 2 DOORS 318 is	M42	G	M	2/89-2/91		
				E30 2 DOORS 318 is	M42	G	M	2/89-2/91	*	
				E30 4 DOORS 316 i M40	M40	G	M	6/88-10/90	*	
				E30 4 DOORS 318 i M40	M40	G	M	9/87-11/91	*	
				E30 CABRIO 318 i	M40	G	M	9/90-11/93	*	
				E30 TOURING 316 i	M40	G	M	6/91-1/95	*	
				E30 TOURING 318 i	M40	G	M	8/90-1/95	*	
				E34 518 i M40	M40	G	M	4/89-5/94		
				E34 518 i M43	M43	G	M	9/90-11/95		
E34 520 i M20	M20	G		M	6/87-9/90					



№ФОРВАРДА	№ OEM	№ NISSENS	МОДЕЛЬ	ТИП ДВИГАТЕЛЯ	БЕН/Д ИЗ	ТИП КП	КОНД ИЦИ	ГОД	ПРИМЕЧА НИЕ
			E34 520 i M50	M50	G	M		9/89-9/91	
			E34 525 i M20	M20	G	M		6/87-8/90	
			E34 525 i M50	M50	G	M		9/89-9/92	
			E34 525 ix	M50	G	M		4/91-/95	
			E34 TOURING 518 g	M43	G	M		/95-/96	
			E34 TOURING 518 i M40	M40	G	M		/92-/94	
			E34 TOURING 518 i M43	M43	G	M		/92-/94	
			E34 TOURING 520 i	M50	G	M		11/90-9/91	
			E34 TOURING 525 i	M50	G	M		12/90-/96	
			E34 TOURING 525 ix	M50	G	M		7/91-/96	
			E36 316 i M40	M40	G	M		11/90-12/94	
			E36 316 i M43	M43	G	M		/93-4/98	
			E36 318 i M40	M40	G	M		11/90-	
			E36 318 i M43	M43	G	M		/93-4/98	
			E36 318 is M42	M42	G	M		/93-/96	
			E36 318 is M44	M44	G	M		3/94-4/98	
			E36 320 i M50	M50	G	M		11/90-/95	
			E36 320 i M52	M52	G	M		/93-4/98	
			E36 323 i	M52	G	M		/94-4/98	
			E36 325 i	M50	G	M		11/89-/95	
			E36 CABRIO 318 i	M43	G	M		/93-4/98	
			E36 CABRIO 318 i M50	M50	G	M		/92-/95	
			E36 CABRIO 320 i M52	M52	G	M		/94-4/98	
			E36 CABRIO 323 i	M52	G	M		/95-4/98	
			E36 CABRIO 325 i	M50	G	M		/92-/95	
			E36 COMPACT 316 g	M43	G	M		/95-4/98	
			E36 COMPACT 316 i 1,6	M43	G	M		/93-4/98	
			E36 COMPACT 318 ti M42	M42	G	M		/94-/96	
			E36 COMPACT 318 ti M44	M44	G	M		/94-/96	
			E36 COUPE 316 i	M43	G	M		/93-4/98	
			E36 COUPE 318 is M42	M42	G	M		/91-/96	
			E36 COUPE 318 is M44	M44	G	M		/95-4/98	
			E36 COUPE 320 i M50	M50	G	M		/91-/95	
			E36 COUPE 320 i M52	M52	G	M		/94-4/98	
			E36 COUPE 323 i	M52	G	M		/94-4/98	
			E36 COUPE 325 i	M50	G	M		11/89-/95	
			E36 TOURING 316 i	M43	G	M		/96-4/98	
			E36 TOURING 318 i	M43	G	M		/95-4/98	
			E36 TOURING 320 i	M52	G	M		3/94-4/98	
			E36 TOURING 323 i	M52	G	M		/95-4/98	
ВМЕ3488-910	1728769/1719306/1737760/1247376/1469177	60743A	E34 '88-95 РАДИАТОР ОХЛАЖДЕН (NISSENS)						520 438 32
ВМЕ3488-913	1728769/1719306/1737760/1247376/1469177	60743A	E34 '88-95 РАДИАТОР ОХЛАЖДЕН						520 438 32





E34 518 i M40	M40	G	A		4/89-5/94
E34 518 i M40	M40	G	M	*	4/89-5/94
E34 518 i M43	M43	G	A		/90-11/95
E34 518 i M43	M43	G	A	*	/90-11/95
E34 518 i M43	M43	G	M	*	/90-11/95
E34 520 i M20	M20	G	M	*	6/87-/90
E34 520 i M50	M50	G	M	*	9/89-/95
E34 520 i M50	M50	G	A	*	9/92-/95
E34 520 i M50	M50	G	A		9/92-/95
E34 525 i M20	M20	G	M	*	6/87-8/90
E34 525 i M50	M50	G	M	*	9/89-/95
E34 525 i M50	M50	G	A		9/92-/95
E34 525 i M50	M50	G	A	*	9/92-/95

№ФОРВАРДА	№ OEM	№ NISSENS	МОДЕЛЬ	ТИП ДВИГАТЕЛЯ	БЕН/Д ИЗ	ТИП КП	КОНД ИЦИ	ГОД	ПРИМЕЧА НИЕ
			E34 525 ix	M50	G	M	*	4/91-/95	
			E34 525 ix	M50	G	A	*	9/92-/95	
			E34 525 ix	M50	G	A	*	9/92-/95	
			E34 TOURING 518 g	M43	G	M	*	/95-/96	
			E34 TOURING 518 i M40	M40	G	M	*	/92-/94	
			E34 TOURING 518 i M43	M43	G	M	*	/92-/94	
			E34 TOURING 520 i	M50	G	A	*	9/92-/96	
			E34 TOURING 520 i	M50	G	M	*	11/90-/96	
			E34 TOURING 520 i	M50	G	A	*	9/92-/96	
			E34 TOURING 525 i	M50	G	A	*	9/92-/96	
			E34 TOURING 525 i	M50	G	M	*	12/90-/96	
			E34 TOURING 525 i	M50	G	A	*	9/92-/96	
			E34 TOURING 525 ix	M50	G	A	*	9/92-/96	
			E34 TOURING 525 ix	M50	G	A	*	9/92-/96	
			E34 TOURING 525 ix	M50	G	M	*	7/91-/96	
ВМЕ3488-911	1719309/1468469/1737760	60709A	E34 '88-94 РАДИАТОР ОХЛАЖДЕН (NISSENS)						520 438 32
ВМЕ3488-912	1719309/1468469/1737760	60709A	E34 '88-94 РАДИАТОР ОХЛАЖДЕН						520 438 32
			E34 525 i M20	M20	G	A	*	6/88-8/90	
			E34 525 i M50	M50	G	A	*	9/89-9/92	
			E34 525 ix	M50	G	A	*	4/91-9/92	
			E34 TOURING 520 i	M50	G	A	*	11/90-9/92	
			E34 TOURING 525 i	M50	G	A	*	12/90-9/92	
			E34 TOURING 525 ix	M50	G	A	*	7/91-9/92	
									
ВМЕ3491-910	1723941	60736A	E34 '91-95 РАДИАТОР ОХЛАЖДЕН (NISSENS)						520 328 32
ВМЕ3491-911	1723941	60736A	E34 '91-95 РАДИАТОР ОХЛАЖДЕН						520 328 32
			E34 520 i M50	M50	G	M	*	9/91-/95	
			E34 TOURING 520 i	M50	G	M	*	9/91-/96	
									
ВМЕ3690-910	1728905/1469176/1247145/1723990/1723898	60623A	E36 '90-00 РАДИАТОР ОХЛАЖДЕН (NISSENS)						440 439 32
ВМЕ3690-912	1728905/1469176/1247145/1723990/1723898	60623A	E36 90-00 РАДИАТОР ОХЛАЖДЕН						440 439 32
			E36 316 i M40	M40	G	M	*	11/90-12/94	
			E36 316 i M40	M40	G	A	*	10/91-12/94	
			E36 316 i M43	M43	G	M	*	/93-04/98	
			E36 316 i M43	M43	G	A	*	/93-04/98	
			E36 318 i M40	M40	G	M	*	11/90-	
			E36 318 i M43	M43	G	M	*	/93-4/98	
			E36 318 i M43	M43	G	A	*	/93-4/98	
			E36 318 is M42	M42	G	M	*	/93-/96	
			E36 318 is M42	M42	G	A	*	/93-/96	
			E36 318 is M44	M44	G	A	*	3/94-4/98	
			E36 318 is M44	M44	G	M	*	3/94-4/98	
			E36 320 i M50	M50	G	A	*	9/92-/95	
			E36 320 i M50	M50	G	A	*	9/92-/95	
			E36 320 i M50	M50	G	M	*	11/90-/95	
									

№ФОРВАРДА	№ OEM	№ NISSENS	МОДЕЛЬ	ТИП ДВИГАТЕЛЯ	БЕН/Д ИЗ	ТИП КП	КОНД ИЦИ	ГОД	ПРИМЕЧА НИЕ
		E36 320 i M50		M50	G	A		11/90-9/92	
		E36 320 i M52		M52	G	A		/93-4/98	
		E36 320 i M52		M52	G	M	*	/93-4/98	
		E36 323 i		M52	G	A		/94-4/98	
		E36 323 i		M52	G	MA	*	/94-4/98	
		E36 325 i		M50	G	A	*	9/92-/95	
		E36 325 i		M50	G	A		11/89-9/92	
		E36 325 i		M50	G	A		9/92-/95	
		E36 325 i		M50	G	M	*	11/89-/95	
		E36 328 i		M52	G	M	*/-	11/94-4/98	
		E36 CABRIO 318 i		M43	G	M	*	/93-4/98	
		E36 CABRIO 318 i		M43	G	A	*	/93-4/98	
		E36 CABRIO 320 i M50		M50	G	M	*	/92-/95	
		E36 CABRIO 320 i M50		M50	G	A	*	/92-/95	
		E36 CABRIO 320 i M50		M50	G	A		/92-/95	
		E36 CABRIO 320 i M52		M52	G	A		/94-4/98	
		E36 CABRIO 320 i M52		M52	G	M	*	/94-4/98	
		E36 CABRIO 323 i		M52	G	A		/95-4/98	
		E36 CABRIO 323 i		M52	G	MA	*	/95-4/98	
		E36 CABRIO 325 i		M50	G	A		/92-/95	
		E36 CABRIO 325 i		M50	G	M	*	/92-/95	
		E36 CABRIO 325 i		M50	G	A	*	/92-/95	
		E36 CABRIO 328 i		M52	G	M	*/-	11/94-4/98	
		E36 COMPACT 316 g		M43	G	M	*	/95-4/98	
		E36 COMPACT 316 i 1,6		M43	G	A	*	/93-4/98	
		E36 COMPACT 316 i 1,9		M43	G	MA		/98-	
		E36 COMPACT 318 ti M42		M42	G	A	*	/94-/96	
		E36 COMPACT 318 ti M42		M42	G	M	*	/94-/96	
		E36 COMPACT 318 ti M44		M44	G	A	*	/94-/96	
		E36 COMPACT 318 ti M44		M44	G	M	*	/94-/96	
		E36 COMPACT 323 ti		M52	G	MA		/97-/98	
		E36 COUPE 316 i		M43	G	M	*	/93-4/98	
		E36 COUPE 316 i		M43	G	A	*	/93-4/98	
		E36 COUPE 318 is M42		M42	G	M	*	/91-/96	
		E36 COUPE 318 is M42		M42	G	A	*	/91-/96	
		E36 COUPE 318 is M44		M44	G	M	*	/95-4/98	
		E36 COUPE 318 is M44		M44	G	A	*	/95-4/98	
		E36 COUPE 320 i M50		M50	G	M	*	/91-/95	
		E36 COUPE 320 i M50		M50	G	A		/91-9/92	
		E36 COUPE 320 i M50		M50	G	A	*	9/92-/95	
		E36 COUPE 320 i M50		M50	G	A		9/92-/95	
		E36 COUPE 320 i M52		M52	G	A		/94-4/98	
		E36 COUPE 320 i M52		M52	G	M	*	/94-4/98	
		E36 COUPE 323 i		M52	G	A		/94-4/98	
		E36 COUPE 323 i		M52	G	A	*	/94-4/98	
		E36 COUPE 325 i		M50	G	A		11/89-9/92	
		E36 COUPE 325 i		M50	G	A		9/92-/95	
		E36 COUPE 325 i		M50	G	M	*	11/89-/95	
		E36 COUPE 325 i		M50	G	A	*	9/92-/95	
		E36 COUPE 328 i		M52	G	M	*/-	/94-4/98	
		E36 TOURING 316 i		M43	G	M	*	/96-4/98	
		E36 TOURING 316 i		M43	G	A	*	/96-4/98	
		E36 TOURING 318 i		M43	G	M	*	/95-4/98	
		E36 TOURING 318 i		M43	G	A	*	/95-4/98	
		E36 TOURING 320 i		M52	G	A		3/94-4/98	
		E36 TOURING 320 i		M52	G	M	*	3/94-4/98	
		E36 TOURING 323 i		M52	G	A		/95-4/98	
		E36 TOURING 323 i		M52	G	M	*	/95-4/98	
		E36 TOURING 328 i		M52	G	M	*/-	/94-4/98	
		E36 Z3 1,8 ROADSTER		M43	G	MA	*/-	/94-/98	
		E36 Z3 1,9 M43 ROADSTER		M43	G	MA	*/-	/98-	
		E36 Z3 1,9 M44 ROADSTER		M44	G	MA	*/-	/95-/98	

№ФОРВАРДА	№ OEM	№ NISSENS	МОДЕЛЬ	ТИП ДВИГАТЕЛЯ	БЕН/Д ИЗ	ТИП КП	КОНД ИЦИ	ГОД	ПРИМЕЧА НИЕ
ВМЕ3690-911	1719264/1723528	60613A	E36 '90-92 {E30 88-91} РАДИАТОР ОХЛАЖДЕН (NISSENS)						440 439 32
ВМЕ3690-913	1719264/1723528	60613	E36 '90-92 {E30 88-91} РАДИАТОР ОХЛАЖДЕН						440 439 32
			E36 316 i M40	M40	G	A	*	11/90-12/91	
			E36 318 i M40	M40	G	A	*	11/90-10/91	
			E36 318 i M40	M40	G	A	*	11/90-10/91	
			E36 320 i M50	M50	G	A	*	11/90-9/92	
			E36 325 i	M50	G	A	*	11/89-9/92	
			E36 COUPE 320 i M50	M50	G	A	*	/91-9/92	
			E36 COUPE 325 i	M50	G	A	*	11/89-9/92	
ВМЕ3691-911	2244647/648	60792	E36 '91-93 РАДИАТОР ОХЛАЖДЕН (NISSENS)						550 408 42
			E36 325 td	M51	D	A	*	90/9-93/9	
			E36 325 td	M51	D	A	*	90/9-93/9	
ВМЕ3691-912	2244753/646	60793	E36 '91-98 РАДИАТОР ОХЛАЖДЕН (NISSENS)						550 408 42
			E36 325 td	M51	D	M	*/-	9/91-4/98	
			E36 325 td	M51	D	A	*/-	9/93-4/98	
ВМЕ3694-910	2245511	60757A	E36 '94-98 РАДИАТОР ОХЛАЖДЕН (NISSENS)						548 328 40
			E36 318 tds	M41	D	M		3/94-4/98	
			E36 318 tds	M41	D	M	*	3/94-4/98	
			E36 COMPACT 318 tds	M41	D	M		3/94-4/98	
			E36 COMPACT 318 tds	M41	D	M	*	3/94-4/98	
			E36 TOURING 318 tds	M41	D	M		3/94-4/98	
			E36 TOURING 318 tds	M41	D	M	*	3/94-4/98	
ВМЕ3893-910	1737813/710/1740702/704	60604A	E38 '93-97 РАДИАТОР ОХЛАЖДЕН (NISSENS)						650 438 32
			E38 730 i	3000M60	G	MA	*/-	/93-/96	
			E38 730 i L	3000M60	G	MA	*/-	/93-9/94	
			E38 740 i L M60	M60	G	A	*	/94-/96	
			E38 740 i L M62	M62	G	A	*	/95-3/97	
			E38 740 i M60	M60	G	A	*	/93-/96	
			E38 740 i M60	M60	G	M	*	/93-9/94	
			E38 740 i M62	M62	G	A	*	/94-3/97	

№ФОРВАРДА	№ OEM	№ NISSENS	МОДЕЛЬ	ТИП ДВИГАТЕЛЯ	БЕН/Д ИЗ	ТИП КП	КОНД ИЦИ	ГОД	ПРИМЕЧА НИЕ
ВМЕ3894-910	1702969/1737711	60752A	E38 '94-98 {E39 95-99} РАДИАТОР ОХЛАЖДЕН (NISSENS)						
			E38 728 i	2800M52	G	MA	*/-	9/94-9/98	
			E38 728 i L	2800M52	G	MA	*/-	9/94-9/98	
			E38 730 i	3000M60	G	MA	*/-	/93-/96	
			E38 730 i L	3000M60	G	MA	*/-	/93-/96	
			E38 735 i	3500M62	G	MA	*/-	/94-9/98	
			E38 735 i L	3500M62	G	MA	*/-	9/94-9/98	
			E38 740 i L M60	M60	G	A	*	/94-/96	
			E38 740 i L M62	M62	G	A	*	/95-9/98	
			E38 740 i M60	M60	G	A	*	/93-/96	
			E38 740 i M60	M60	G	M	*	9/94-/96	
			E38 740 i M62	M62	G	M	*	/94-9/98	
			E38 740 i M62	M62	G	A	*	/94-9/98	
			E38 750 i	M73	G	MA	*	/93-9/98	
			E38 750 i L	M73	G	MA	*	/94-9/98	
			E39 523 i T		G	MA	*	/97-3/99	
		E39 535 i	3498M62	G	MA	*	/95-9/98		
		E39 540 i	4398M62	G	MA	*	/95-9/98		
		E39 TOURING 528 i	2793M52	G	MA	*/-	/96-9/98	HD	
		E39 TOURING 540 i	M52	G	MA	*/-	/96-9/98		
ВМЕ3895-910	2246012/009/010/011	60603A	E38 '95- {E39 94-} РАДИАТОР ОХЛАЖДЕН (NISSENS)						650 439 32
			E38 725 TDS	2503M51	D	A	*/-	9/95-	
			E39 525 tds	2498M51	D	MA	*/-	/96-	
			E39 525 tds	2498M51	D	MA	*/-	9/94-	
			E39 TOURING 525 tds	2498M51	D	A	*	/96-	
			E39 TOURING 525 tds	2498M51	D	MA	*	/96-	
			E39 TOURING 525 tds	2498M51	D	M	*	/96-	
ВМЕ3898-910	1436063	60754A	E38 '98- {E39 98-} РАДИАТОР ОХЛАЖДЕН (NISSENS)						650 438 40
			E38 735 i	3500M62	G	MA	*/-	9/98-	
			E38 735 i L	3500M62	G	MA	*/-	9/98-	
			E38 740 i L M62	M62	G	A	*	9/98-	HD
			E38 740 i M62	M62	G	A	*	9/98-	HD
			E38 750 i	M73	G	MA	*	9/98-	
			E38 750 i L	M73	G	MA	*	9/98-	
			E39 535 i	3498M62	G	A	*	9/98-	HD
		E39 TOURING 540 i	M52	G	MA	*/-	9/98-		
ВМЕ3898-911	2247345	60634	E38 '98- {E39 98-} РАДИАТОР ОХЛАЖДЕН (NISSENS)						650 328 42
			E38 730 d		D	MA	*/-	/97-	
			E38 740 d		D	MA	*/-	/98-	
			E39 520 d		D	MA	*/-	/99-	
			E39 525 d		D	MA	*/-	/99-	
			E39 530 d	2926M57	D	MA	*	8/98-	
			E39 TOURING 520 d		D	MA	*/-	/99-	
			E39 TOURING 525 d		D	MA	*/-	/99-	
		E39 TOURING 530 d	2926M57	D	MA	*/-	8/98-		

№ФОРВАРДА	№ OEM	№ NISSENS	МОДЕЛЬ	ТИП ДВИГАТЕЛЯ	БЕН/Д ИЗ	ТИП КП	КОНД ИЦИ	ГОД	ПРИМЕЧА НИЕ
ВМЕ3995-910	1740698/695/701/699/1427153/154	60607A	E39 '95-98 РАДИАТОР ОХЛАЖДЕН (NISSENS)						520 439 32
ВМЕ3995-911	1740698/695/701/699/1427153/154	60607A	E39 '95-98 РАДИАТОР ОХЛАЖДЕН						520 439 32
			E39 520 i M52	1994M52	G	M		9/95-10/96	
			E39 520 i M52	1994M52	G	A		9/95-9/98	
			E39 520 i M52	1994M52	G	MA	*	9/95-9/98	
			E39 523 i	2256M52	G	M		9/95-10/96	
			E39 523 i	2256M52	G	A		9/95-9/98	
			E39 523 i	2256M52	G	MA	*	9/95-9/98	
			E39 528 i	2793M52	G	M		/95-10/96	
			E39 528 i	2793M52	G	A		/95-9/98	
			E39 528 i	2793M52	G	MA	*	9/95-9/98	
			E39 TOURING 520 i M52	1994M52	G	A		/96-9/98	
			E39 TOURING 520 i M52	1994M52	G	MA	*	/96-9/98	
			E39 TOURING 523 i	2256M52	G	A		/96-9/98	
			E39 TOURING 523 i	2256M52	G	MA	*	/96-9/98	
			E39 TOURING 528 i	2793M52	G	A		/96-9/98	
			E39 TOURING 528 i	2793M52	G	MA	*	/96-9/98	
			E39 TOURING 528 i	2793M52	G	MA	*	/96-9/98	
ВМЕ4698-910	9071518/19	60782A	E46 '98-03 {+Z4} РАДИАТОР ОХЛАЖДЕНИЯ (NISSENS)						582 439 32
ВМЕ4698-912	9071518/9071519	60782	E46 '98-03 {+Z4} РАДИАТОР ОХЛАЖДЕН						582 439 32
			3E 46 316i		G	M	*	98/2-	
			3E 46 316i		G	A	*	98/2-	
			3E 46 316i		G	A		98/2-	
			3E 46 316d		G	M	*	01/6-	
			3E 46 316d		G	A	*	01/6-	
			3E 46 316d		G	A		01/6-	
			3E 46 318d		D	M	*	98/2-	
			3E 46 318d		D	M		98/2-	
			3E 46 318i		G	M	*	98/2-	
			3E 46 318i		G	A	*	98/2-	
			3E 46 318i		G	A		98/2-	
			3E 46 318td		D	M	*	01/6-	
			3E 46 318td		D	M		01/6-	
			3E 46 318d	N42	G	M/A	*	01/6-	
			3E 46 318d	N42	G	M/A		01/6-	
			3E 46 318d	N42	G	M	*	01/6-	
			3E 46 318d	N46	G	A	*	01/6-	
			3E 46 318d	N46	G	A		01/6-	
			3E 46 320d		D	M/A	*	98/2-	
			3E 46 320d		D	M/A		98/2-	
3E 46 320i		G	M	*	98/2-				
3E 46 320i		G	A	*	98/2-				
3E 46 320i		G	M		98/2-				
3E 46 320i		G	A		98/2-				
3E 46 320td		D	M	*	01/6-				
3E 46 320td		D	M		01/6-				
3E 46 323i		G	M	*	98/2-				
3E 46 323i		G	A	*	98/2-				
3E 46 323i		G	M		98/2-				

№ ФОРВАРДА	№ OEM	№ NISSENS	МОДЕЛЬ	ТИП ДВИГАТЕЛЯ	БЕН/Д ИЗ	ТИП КП	КОНД ИЦИ	ГОД	ПРИМЕЧА НИЕ
		3E 46 323i			G	A		98/2-	
		3E 46 325i			G	M/A	*	98/2-	
		3E 46 325ti			G	M	*	01/6-	
		3E 46 325ti			G	M		01/6-	
		3E 46 328i			G	M	*	98/2-	
		3E 46 328i			G	A	*	98/2-	
		3E 46 328i			G	M		98/2-	
		3E 46 328i			G	A		98/2-	
		3E 46 330d			D	M/A	*	98/2-	
		3E 46 330d			D	M/A		98/2-	
		3E 46 330i			G	M/A	*	98/2-	
		Z4 2, 0i			G	A	*	2/01-	
		Z4 2, 2i			G	A	*	2/01-	
		Z4 2, 5i			G	A	*	2/01-	
		Z4 3, 0i			G	A	*	2/01-	

ВМЕ4698-911 17119071517 60784A E46 {+Z4}98-03 РАДИАТОР ОХЛАЖДЕН (NISSENS) 582 439 22

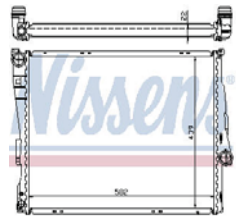

3 E 46 316 i		G	M	-	02/98 -
3 E 46 318 i		G	M	-	02/98 -
3 E 46 COMPACT 316 ti		G	M	-	06/01 -
3 E 46 COMPACT 318 ti	N46	G	M	-	06/01 -
Z4 2.0 i		G	M	+	01/02 -
Z4 2.2 i		G	M	+	01/02 -
Z4 2.5 i		G	M	+	01/02 -
Z4 3.0 i		G	M	+	01/02 -

ВМЕ6002-910 7519209/7519211 60763 E60 '02- РАДИАТОР ОХЛАЖДЕНИЯ (NISSENS) 623 486 24

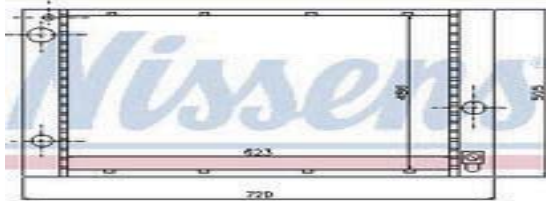

5E 60 520i		G	M/A	*	02/1-
5E 60 520i		G	M/A	*	02/1-04/3
5E 60 525i	M54	G	M/A	*	02/1-
5E 60 525i	M54	G	M/A	*	02/1-04/3
5E 60 530i	M54	G	M/A	*	02/1-
5E 60 530i	M54	G	M/A	*	02/1-04/3

СNBER96-910 133047/1331CT 63716 BERLINGO '96- {+PARTNER 98-} РАДИАТОР ОХЛАЖДЕНИЯ (NISSENS) 610 378 23

СNBER96-911 133047 63716 BERLINGO 96- {+PARTNER 98-} РАДИАТОР ОХЛАЖДЕН 610 378 23

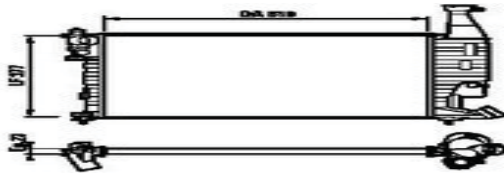





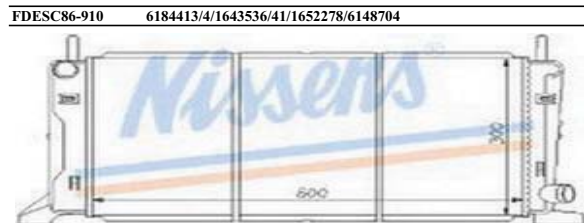

BERLINGO 1,4i	1360 TU3JP	G	M	*/-	98/10-
BERLINGO 1,6i 16V	1587 TU5JP4	G	M	*/-	98/10-
BERLINGO 1,8i	1762 XU7JB	G	M	*/-	98/10-
PARTNER 1,4i	1360 TU3JP	G	M	*/-	98/10-
PARTNER 1,6i 16V	1587 TU5JP4	G	M	*/-	98/10-
PARTNER 1,8i	1762 XU7JB	G	M	*/-	98/10-

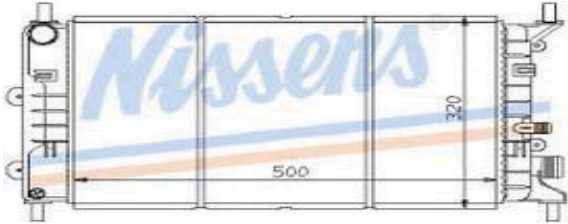
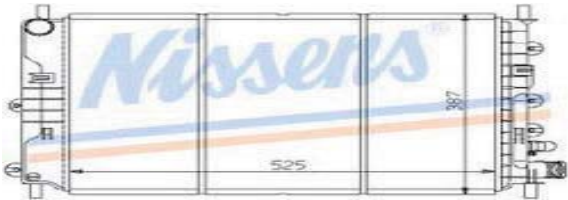
№ФОРВАРДА	№ OEM	№ NISSENS	МОДЕЛЬ	ТИП ДВИГАТЕЛЯ	БЕН/Д ИЗ	ТИП КП	КОНД ИЦИ	ГОД	ПРИМЕЧА НИЕ
			RELAY (02-) 2.0 Hdi	DW10JTD	D	M	-	01/02 -	
			RELAY (02-) 2.0 Hdi	DW10JTD	D	M	+	01/02 -	
			RELAY (02-) 2.2 Hdi	DW12TED4	D	M	-	01/02 -	
			RELAY (02-) 2.2 Hdi	DW12TED4	D	M	+	01/02 -	
			RELAY (02-) 2.8 Hdi	F28TDCR	D	M	-	01/02 -	
			RELAY (02-) 2.8 Hdi	F28TDCR	D	M	+	01/02 -	
			DUCATO (94-) 2.0 i	RFW	G	M	+	02/94 - 01/02	
			DUCATO (94-) 1.9 D	D9B	D	M	+/-	02/94 - 01/02	
			DUCATO (94-) 1.9 TD	XUD9TF	D	M	+	02/94 - 01/02	
			DUCATO (94-) 2.0 JTD	DW10TD	D	M	+	02/94 - 01/02	
			DUCATO (94-) 2.0 JTD	DW10TD	D	M	-	02/94 - 01/02	
			DUCATO (94-) 2.5 D	8140.67	D	M	-	02/94 - 08/98	
			DUCATO (94-) 2.5 JTD	8140.47	D	M	-	02/94 - 01/02	
			DUCATO (94-) 2.5 TD	8140.47	D	M	-	02/94 - 01/02	
			DUCATO (94-) 2.8 D	8140.63	D	M	+/-	02/94 - 01/02	
			DUCATO (94-) 2.8 JTD	8140.43S	D	M	+/-	02/94 - 11/01	
			DUCATO (94-) 2.8 TD	8140.43	D	M	+/-	02/94 - 11/01	
			DUCATO (02-) 2.0 JTD	DW10TD	D	M	-	01/02 -	
			DUCATO (02-) 2.0 JTD	DW10TD	D	M	+	01/02 -	
			DUCATO (02-) 2.2 JTD	DW12TED	D	M	-	01/02 -	
			DUCATO (02-) 2.2 JTD	DW12TED	D	M	+	01/02 -	
			DUCATO (02-) 2.3 JTD	F1AE0481C	D	M	-	01/02 -	
			DUCATO (02-) 2.3 JTD	F1AE0481C	D	M	+	01/02 -	
			DUCATO (02-) 2.8 JTD	8140.43S	D	M	-	01/02 -	
			DUCATO (02-) 2.8 JTD	8140.43S	D	M	+	01/02 -	
			DUCATO (02-) 2.8 TD	8140.43S	D	M	-	01/02 -	
			BOXER (94-) 2.0	XU10J2U	G	M	+	02/94 - 01/02	
			BOXER (94-) 1.9 D	XUD9AU	D	M	+/-	02/94 - 01/02	
			BOXER (94-) 1.9 TD	XUD9UTF	D	M	+/-	02/94 - 01/02	
			BOXER (94-) 2.5 D	DJ5	D	M	-	02/94 - 01/02	
			BOXER (94-) 2.5 TD	DJ5T	D	M	-	02/94 - 01/02	
			BOXER (94-) 2.8 D	SOFIM	D	M	+/-	02/94 - 01/02	
			BOXER (94-) 2.8 Hdi	8140-43	D	M	+/-	02/94 - 01/02	
			BOXER (94-) 2.8 TD	8140-43/63	D	M	+/-	02/94 - 01/02	
			BOXER (02-) 2.0 Hdi	DW10TD	D	M	-	01/02 -	
			BOXER (02-) 2.0 Hdi	DW10TD	D	M	+	01/02 -	
			BOXER (02-) 2.2 Hdi	DW12TED	D	M	-	01/02 -	
			BOXER (02-) 2.2 Hdi	DW12TED	D	M	+	01/02 -	
			BOXER (02-) 2.8 Hdi	8140-43S	D	M	-	01/02 -	
			BOXER (02-) 2.8 Hdi	8140-43S	D	M	+	01/02 -	
			BOXER (02-) 2.8 TD	8140-43S	D	M	-	01/02 -	

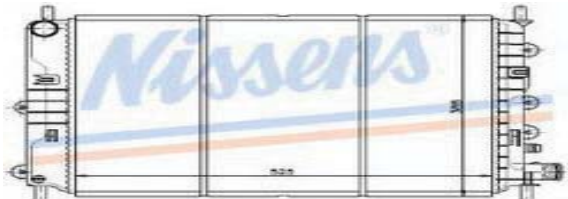

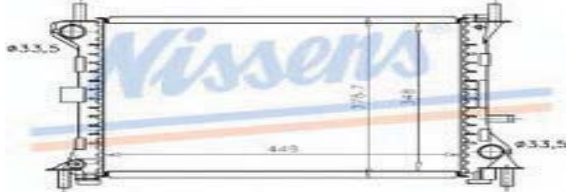

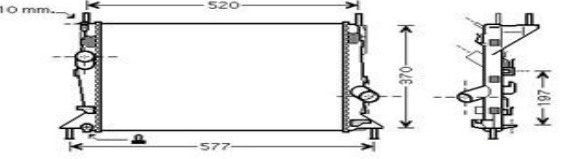
FDESC86-910	6184413/4/1643536/41/1652278/6148704	62154	ESCORT '86-90 РАДИАТОР ОХЛАЖДЕН (NISSENS)					600 300 33
			ESCORT IV 1,6D	1608D16	D	M		3/86-8/90
			ESCORT IV 1,6XR31	1598HL161	G	M		3/86-8/90
			ESCORT IV 1,8D	1753D18	D	M		11/88-6/89
			ORION II 1,4	1397HL14	G	M		3/86-8/90
			ORION II 1,6	1598HL16	G	M		3/86-8/90
			ORION II 1,6D	1608D16	D	M		3/86-8/90
			ORION II 1,6i	1598HL161	G	M		3/86-8/90
			ORION II 1,8D	1753D18	D	M		11/88-6/89

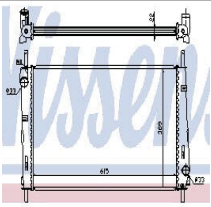
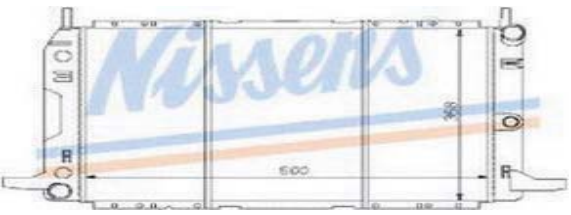

№ФОРВАРДА	№ OEM	№ NISSENS	МОДЕЛЬ	ТИП ДВИГАТЕЛЯ	БЕН/Д ИЗ	ТИП КП	КОНД ИЦИ	ГОД	ПРИМЕЧА НИЕ
FDESC90-910	6912232/6562898/1664070/92AB8005CB/DB/CC	621621	ESCORT '90-95 РАДИАТОР ОХЛАЖДЕН (NISSENS)						500 320 33
FDESC90-914	92AB8005CB/DB	62162	ESCORT '90-95 РАДИАТОР ОХЛАЖДЕН (DELPHI)						
			ESCORT V 1,4 CF i	1392HL14	G	M		1/94-1/95	
			ESCORT V 1,4 EF i	1392HL14	G	M		8/90-1/95	
			ESCORT V 1,6 EF i	1597HL16	G	M		8/90-1/95	
			ESCORT VI 1,6 G	1597HL16	G	M		1/95-	
			ORION III 1,4/1,4I	1392HL14/HL14I	G	M		9/90-	
			ORION III 1,6/1,6I	1597HL16/HL16I	G	M		9/90-	
FDESC90-911	6912231/1029559/6562896/92AB8005BC/YC	62164A	ESCORT '90-95 {ESCORT 96-} РАДИАТОР ОХЛАЖДЕН (NISSENS)						525 390 32
			ESCORT V 1,8TD	1753D18T	D	M		8/90-1/95	
			ESCORT V 1,8TD	1753D18T	D	M	*	8/90-1/95	
			ESCORT VI 1,8D	1752D18	D	M		8/90-1/95	
			ESCORT VI 1,8D	1753D18	D	M	*/-	1/95-	
			ESCORT VI 1,8TD	1753D18T	D	M	*/-	1/95-	
			ORION III 1,8D	1752D18	D	M		9/90-	
FDESC90-912	6912237/33/6616483/1664633/92AB8005EB/EC	62217A	ESCORT '90-95 {ESCORT 96-} РАДИАТОР ОХЛАЖДЕН (NISSENS)						525 389 32
			ESCORT V 1,4EF i	1392HL14	G	M	--	1/94-9/94	
			ESCORT V 1,4EF i	1392HL14	G	M	*	8/90-1/95	
			ESCORT V 1,6 EF i	1597ZH16	G	M	*	9/92-1/95	ZETEC
			ESCORT V 1,6 EF i	1597ZH16	G	M		1/92-	ZETEC
			ESCORT V 1,8EF i	1796ZH18	G	M		1/92-1/95	
			ESCORT V 1,8EF iXR3i	1796ZH18	G	M		1/92-	
			ESCORT V 2,0EF i 16VRS	1998DH20	G	M		8/90-1/95	
			ESCORT VI 1,4EF i	1392HL14	G	M		1/95-	
			ESCORT VI 1,6 CF i	1597ZH16	G	M	*/-	1/95-	
			ESCORT VI 1,6EF i	1597ZH16	G	M	*/-	1/95-	
			ESCORT VI 1,6G	1597HL16	G	M	*	1/95-	
			ESCORT VI 1,8EF i	1796ZH18	G	M		1/95-	105HP
			ESCORT VI 1,8EF i	1796ZH18	G	M		1/95-	130HP
			ESCORT VI 1,8EF i	1796ZH18	G	M		1/95-8/97	115HP
			ESCORT VI 1,8EF i	1796ZH18	G	M	*/-	8/97-	115HP
			ESCORT VI 2,0EF i 16V	1998DH20	G	M		1/95-8/96	
			ORION III 1,6 16V	1597ZH16	G	M		7/92-	
			ORION III 1,8 16V	1796ZH18N/P	G	M		7/92-	
FDESC90-913	6912234/92AB8005FA/B/C/D	62047	ESCORT '90-95 {ESCORT 96-} РАДИАТОР ОХЛАЖДЕН (NISSENS)						525 388 42
			ESCORT V 1,8EF i	1796ZH18	G	M	*	8/90-1/95	
			ESCORT V 2,0EF i 16VRS	1998DH20	G	M	*	5/93-1/95	
			ESCORT VI 1,8EF i	1796ZH18	G	M	*	1/95-8/97	115HP
			ESCORT VI 1,8EF i	1796ZH18	G	M	*	1/95-	130HP
			ESCORT VI 2,0EF i 16V	1998DH20	G	M	*	1/95-8/96	

№ФОРВАРДА	№ OEM	№ NISSENS	МОДЕЛЬ	ТИП ДВИГАТЕЛЯ	БЕН/Д ИЗ	ТИП КП	КОНД ИЦИ	ГОД	ПРИМЕЧА НИЕ
FDFOC98-910	1093713/98AB8005JB/C	62074A	FOCUS '98- РАДИАТОР ОХЛАЖДЕН (NISSENS)						449 379 22
			FOCUS 1,4EF i FOCUS 1,6EF i	1388ZH14 1596ZH16	G G	M M	— —	8/98- 8/98-	
FDFOC98-911	1061180/1093711/95AB8005DD/DE/PC	62075A	FOCUS '98- РАДИАТОР ОХЛАЖДЕН (NISSENS)						596 378 22
FDFOC98-912	1061180/1093711/95AB8005DD/DE/PC	62075	FOCUS '98- РАДИАТОР ОХЛАЖДЕН						597 378 22
			FOCUS 1,4EF i FOCUS 1,6EF i FOCUS 1,8EF i	1388ZH14 1596ZH16 1796ZH18	G G G	M M M	* * */-	8/98- 8/98- 8/98-	
FDFOC05-910	1305491	62112	FOCUS 05- РАДИАТОР ОХЛАЖДЕН (NISSENS)						450 376 14
			FOCUS 1.4 i 16V FOCUS 1.6 i 16V FOCUS C-MAX 1.6 i 16V		G G G	M M/A M/A	- - -	07/04 - 07/04 - 10/03 -	
FDUS02-910	120655012147842S6H8005BB2S6H8K161BB	62026A	FUSION '02-04 (+ FIESTA 02-)РАДИАТОР ОХЛАЖДЕНИЯ (NISSENS)						499 349 22
			FIESTA 1,25 EFi FIESTA 1,4 EFi FIESTA 1,6 EFi FUSION 1,25 EFi FUSION 1,4 EFi FUSION 1,6 EFi	FUJA FXJ FYJA FUJA FXJ FYJA	G G G G G G	M M M M M M	*/- */- */- */- */- */-	01/11-04/1 01/11-04/1 01/11-04/1 01/11-04/1 01/11-04/1 01/11-04/1	

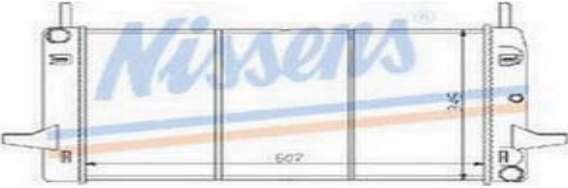
№ФОРВАРДА	№ OEM	№ NISSENS	МОДЕЛЬ	ТИП ДВИГАТЕЛЯ	БЕН/Д ИЗ	ТИП КП	КОНД ИЦИ	ГОД	ПРИМЕЧА НИЕ
FDUS02-911	1141491/1152149/1214085/1325832/13597982S6H8005AC/Y40115200 62027A	FUSION '02- {+ FIESTA 02-/MAZDA 2 03-} РАДИАТОР ОХЛАЖДЕНИЯ(NISSENS)							499 349 22
		FIESTA 1,3 EFI FIESTA 1,3 EFI FIESTA 1,4 TDCi FIESTA 1,4 TDCi FUSION 1,3 EFI FUSION 1,3 EFI MAZDA 2 1,4 DE MAZDA 2 1,6 DE	A9J BAJA F6JA F6JA A9J BAJA F6JA	G G D D G G D D	M M M M M M M M	*/- */- */- */- */- */- */- */-	04/03- 04/03- 01/11-03/12 01/11-03/12 04/03- 04/03- 03/04-03/12 03/04-03/12		
FDUS02-912	1141490/1214785/1222562/2S6H8005CC/1325831/C20115200 62028A	FUSION '02- {+ FIESTA 02-/MAZDA 2 03-} РАДИАТОР ОХЛАЖДЕНИЯ (NISSENS)							499 349 16
		FIESTA 1,25 EFI FIESTA 1,3 EFI FIESTA 1,3 EFI FIESTA 1,4 EFI FIESTA 1,6 EFI FUSION 1,25 EFI FUSION 1,3 EFI FUSION 1,3 EFI FUSION 1,4 EFI FUSION 1,6 EFI MAZDA 2 1,6i 16V MAZDA 2 1,6i 16V MAZDA 2 1,3i 16V MAZDA 2 1,3i 16V MAZDA 2 1,4i 16V MAZDA 2 1,4i 16V	FUJA A9J BAJA FXJ FYJA FUJA A9J BAJA FXJ FYJA ZYVE ZYVE ZJVE ZJVE FXJA FXJA	G G G G G G G G G G G G G G G G G	M M M M M M M M M M M M M M M M M	*/- */- */- */- */- */- */- */- */- */- */- */- */- */- */-	04/01- 01/11-04/03 01/11-04/04 04/01- 04/01- 04/01- 01/11-04/03 01/11-04/03 04/01- 04/01- 03/04-04/01 04/01- 03/04-04/01 04/01- 03/04-04/01 04/01-		
FDGAL95-911	7M0121253B	63991	GALLAXY '96- {SHARAN 95-/ALHAMBRA 96-} РАДИАТОР ОХЛАЖДЕН						647 377 34
		GALAXY (95-) 1.9 Tdi ALHAMBRA (96-) 2.0 i ALHAMBRA (96-) 1.9 Tdi ALHAMBRA (96-) 1.9 Tdi ALHAMBRA (96-) 1.9 Tdi SHARAN (95-) 1.9 Tdi SHARAN (95-) 1.9 Tdi SHARAN (95-) 1.9 Tdi SHARAN (95-) 1.9 Tdi SHARAN (95-) 2.0 i SHARAN (95-) 2.0 i	ADY AFN AHU IZ IZ AFN AHU AVG ADY ADY	D G D D D D D D D G G	M/A M/A M/A M M M/A M M/A M/A M M A	+/- +/- +/- +/- +/- +/- +/- +/- +/- +/- +/-	10/95 - 03/96 - 02/00 09/97 - 02/00 05/97 - 02/00 03/96 - 07/96 09/95 - 07/96 12/96 - 07/99 08/96 - 02/00 08/99 - 02/00 09/95 - 02/00 09/95 - 02/00		

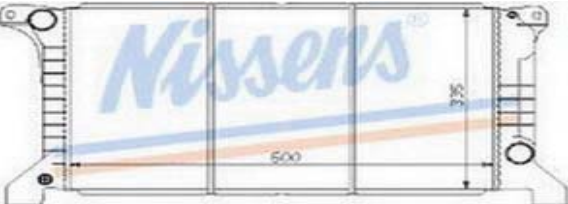
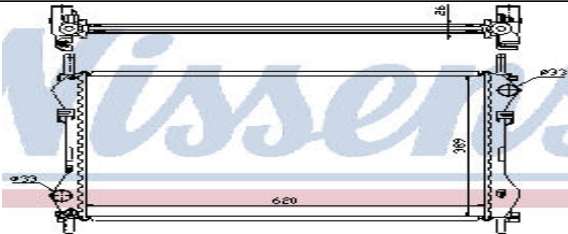
№ ФОРВАРДА	№ OEM	№ NISSENS	МОДЕЛЬ	ТИП ДВИГАТЕЛЯ	БЕН/Д ИЗ	ТИП КП	КОНД ИЦИ	ГОД	ПРИМЕЧА НИЕ
FDMON93-910	6899903/1086946/93BB8005ED	62104A	MONDEO '93-00 РАДИАТОР ОХЛАЖДЕН (NISSENS)						616 419 22
FDMON93-911	6899903/1086946/93BB8005ED	62104	MONDEO '93-00 РАДИАТОР ОХЛАЖДЕН						616 419 22
			MONDEO I 1,6 16V	1597ZH16	G	M	*/-	3/93-8/96	
			MONDEO I 1,8 16V	1796ZH18	G	M	*/-	3/93-8/96	
			MONDEO I 2,0 16V	1988ZH20	G	M	*/-	3/93-8/96	
			MONDEO II 1,6EF i	1597ZH16	G	M	*/-	8/96-	
			MONDEO II 1,8EF i	1796ZH18	G	M	*/-	8/96-	
			MONDEO II 2,0EF i	1988ZH20	G	M	*/-	8/96-	
FDMON00-910	1142808/1S7H8005AD/CA/CC/AA	620411	MONDEO 00- РАДИАТОР ОХЛАЖДЕН (NISSENS)						616 389 22
FDMON00-911	1142808/1S7H8005AD/CA/CC/AA	62041	MONDEO 00- РАДИАТОР ОХЛАЖДЕН						616 389 22
			MONDEO 1.8 i 16V	CGBA/CGBB	G	M/A	+/-	10/00 -	
			MONDEO 2.0 i 16V	CJBA/CGBB	G	M/A	+/-	10/00 -	
			MONDEO 3.0 i V6 24V	REBA	G	M/A	+/-	05/02 -	
			MONDEO ST 220	MEBA	G	M/A	+/-	05/02 -	
FDSCR89-910	6184416/6165323/1652281/86GB8005AC	62228	SCORPIO '89-94 РАДИАТОР ОХЛАЖДЕН (NISSENS)						600 368 42
			GRANADA 85 2,0,2,0I TWIN CAM	1998DL20/DL20I	G	M	*/-	9/89-	
			GRANADA 85 2,4I	2394TV24	G	M	*/-	2/86-	
			GRANADA 85 2,9I	2933TV29	G	M	*/-	2/86-	
			SCORPIO 2,0,2,0I TWIN CAM	1998DL20/DL20I	G	M	*/-	9/89-9/94	
			SCORPIO 2,4I	2394TV24	G	M	*/-	2/86-9/94	
			SCORPIO 2,9I	2933TV29	G	M	*/-	2/86-9/94	
FDSCR89-911	6165324/6184417/1652282/86GB8005BC	62229	SCORPIO '89-94 РАДИАТОР ОХЛАЖДЕН (NISSENS)						600 368 42
			SCORPIO 2,0,2,0I TWIN CAM	1998DL20/DL20I	G	A	*/-	9/89-9/94	
			SCORPIO 2,4I	2394TV24	G	A	*/-	2/86-9/94	
			SCORPIO 2,9I	2933TV29	G	A	*/-	2/86-9/94	

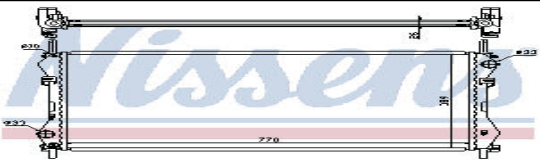
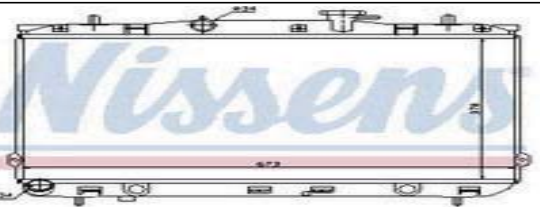
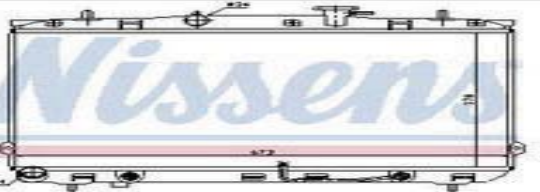
№ФОРВАРДА	№ OEM	№ NISSENS	МОДЕЛЬ	ТИП ДВИГАТЕЛЯ	БЕН/Д ИЗ	ТИП КП	КОНД ИЦИ	ГОД	ПРИМЕЧА НИЕ
FDSIE87-910	1652501/87BB8005GA/GB/1640385	62178	SIERRA '87-93 РАДИАТОР ОХЛАЖДЕН (NISSENS)						607 345 33
			SIERRA 87 1,4 SIERRA 87 1,6 SIERRA 87 1,8	1392TL14 1593TL16OHC 1796TL18OHC	G G G	M M M		1/8710/87 1/87-3/93 1/87-3/93	
FDTRT86-910	6160271/4/86VB8005EB/BB/BC	62369A	TRANSIT '86-92 РАДИАТОР ОХЛАЖДЕН (NISSENS)						600 335 33
			TRANSIT III 1,6 TRANSIT III 2,0 TRANSIT III 2,5D TRANSIT TOURNEO 2,0/2,0I TRANSIT TOURNEO 2,5D	1593TL16 1994TL20/TL20I 2496D25 1994TL20/TL20I 2496D25	G G D G D	M M M M M		11/85-8/92 11/85-8/92 11/85-8/92 11/85- 11/85-	
FDTRT91-910	6640241/1040077/92VB8005FC/BC/BD/BE/EC	62177	TRANSIT '91-94 РАДИАТОР ОХЛАЖДЕН (NISSENS)						600 329 32
FDTRT91-911	6640241/1040077/92VB8005FC/BC/BD/BE/EC	62177	TRANSIT '91-'94 РАДИАТОР ОХЛАЖДЕН						600 329 32
			TRANSIT IV 2,0EF i TRANSIT IV 2,5D	1993TL20 D25NA	G D	M M		8/91-8/94 9/92-8/94	
FDTRT00-910	1104319/4323785/4484464/459670	62044A	TRANSIT 00- РАДИАТОР ОХЛАЖДЕН (NISSENS)						620 389 26
			TRANSIT 2.4 D 75 HP TRANSIT 2.4 D 90 HP TRANSIT 2.4 D 115 HP TRANSIT 2.4 D 120 HP TRANSIT 2.4 D 125 HP TRANSIT 2.4 TDCI 135 HP		D D D D D D	M M M M M M	- - - - - -	01/00 - 01/00 - 01/00 - 01/00 - 01/00 - 03/04 -	

№ ФОРВАРДА	№ OEM	№ NISSENS	МОДЕЛЬ	ТИП ДВИГАТЕЛЯ	БЕН/Д ИЗ	ТИП КП	КОНД ИЦИ	ГОД	ПРИМЕЧА НИЕ
FDTRT00-911	1104320/1113204/УС1Н8005СD/СE	62043А	TRANSIT '00- РАДИАТОР ОХЛАЖДЕН (NISSENS)						770 389 26
			TRANSIT 2.4 D 75 HP		D	M	+	01/00 -	
			TRANSIT 2.4 D 90 HP		D	M	+	01/00 -	
			TRANSIT 2.4 D 115 HP		D	M	+	07/00 -	
			TRANSIT 2.4 D 120 HP		D	M	+	07/00 -	
			TRANSIT 2.4 D 125 HP		D	M	+	07/00 -	
			TRANSIT 2.4 TDCI 135 HP		D	M	+	03/04 -	
			TRANSIT 2.3 I 16V		G	M	+/-	01/00 -	
HNELA00-910	253102D500	67024	ELANTRA '00- РАДИАТОР ОХЛАЖДЕНИЯ (NISSENS)						378 673 16
			ELANTRA 1,6i	1599	G	M	*/-	00/2-	
			ELANTRA 2,0CDRi	1975	D	M	*/-	00/04-	
			ELANTRA 2,0i	1975	G	M	*/-	00/04-	
			LANTRA 1,5i	1495	G	M	*/-	00/04-	
			LANTRA 1,6i 16V	1599	G	M	*/-	00/04-	
			LANTRA 2,0i 16V	1975	G	M	*/-	00/04-	
HNELA00-911	253102D510	67025	ELANTRA '00- РАДИАТОР ОХЛАЖДЕНИЯ (NISSENS)						378 673 16
			ELANTRA 1,6i	1599	G	A	*/-	00/04	
			ELANTRA 2,0 CDRi		D	A	*/-	00/04	
			ELANTRA 2,0i	1975	G	A	*/-	00/04	
			LANTRA 1,5i	1495	G	A	*/-	00/04	
			LANTRA 1,6i 16V	1599	G	A	*/-	00/04	
			LANTRA 2,0i 16V	1975	G	A	*/-	00/04	
HNGEZ02-910	25310-1C100	67495	GETZ '02- РАДИАТОР ОХЛАЖДЕНИЯ (NISSENS)						372 495 19
			GETZ 1,1i	1086	G	M	*/-	02/9-	
			GETZ 1,3i	1341	G	M	*/-	02/9-	
			GETZ 1,4i	1399	G	M	*/-	02/9-	
			GETZ 1,6i	1594	G	M	*/-	02/9-	

№ФОРВАРДА	№ OEM	№ NISSENS	МОДЕЛЬ	ТИП ДВИГАТЕЛЯ	БЕН/Д ИЗ	ТИП КП	КОНД ИЦИ	ГОД	ПРИМЕЧА НИЕ
HNGEZ02-911	253101C150	67496	GETZ '02- РАДИАТОР ОХЛАЖДЕНИЯ (NISSENS)						372 495 19
HNGEZ02-912	253101C150	67496	GETZ '02-РАДИАТОР ОХЛАЖДЕН						372 495 19



GETZ 1,3i 1341 G A +/- 02/09-
GETZ 1,4i 1399 G A +/- 02/09-

HNSON94-915	2531034000	67006	SONATA '95- РАДИАТОР ОХЛАЖДЕН МТ						400 675 25
-------------	------------	-------	----------------------------------	--	--	--	--	--	------------

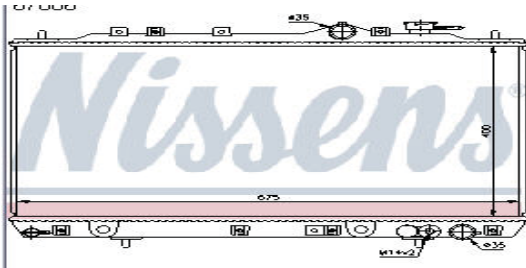

SONATA (95-) 1.8 i
SONATA (95-) 2.0 i
SONATA (95-) 2.0 i 16V
SONATA (95-) 3.0 i V6

G4CP G M +/- 07/95 > 02/98
G4CP-DM G M +/- 07/95 > 02/98
G6AT G M +/- 07/95 > 02/98

LRFR197-910	PCC000320	64310A	FREELANDER '97- РАДИАТОР ОХЛАЖДЕНИЯ (NISSENS)						612 459 32
-------------	-----------	--------	---	--	--	--	--	--	------------



FREELANDER 1,8i K16 G M/A +/- 00/9-
FREELANDER 2,0 TD 16V M47 D M +/- 97/9-
FREELANDER 2,5i 24V KV6 G M/A +/- 00/10-

MBCAR95-915	MB925637/MR299522	62857A	CARISMA '95-04 РАДИАТОР ОХЛАЖДЕН МТ 1.6 1.8 (NISSENS)						400 659 22
-------------	-------------------	--------	---	--	--	--	--	--	------------



CARISMA DA 1,8 1731 2A G M 6/95-
CARISMA DA 1,6 1597 1A G M 6/95-
SPACE STAR 1,3 i 16V 4G13
SPACE STAR 1,6 i 16V 4G16
SPACE STAR 1,8 i 16V 4G18
SPACE STAR 1,8 i 16V 4G93

№ФОРВАРДА	№ OEM	№ NISSENS	МОДЕЛЬ	ТИП ДВИГАТЕЛЯ	БЕН/Д ИЗ	ТИП КП	КОНД ИЦИ	ГОД	ПРИМЕЧА НИЕ
МBCAR95-916	MB925638	62860A	CARISMA '95-04 РАДИАТОР ОХЛАЖДЕН АТ 1.6 1.8 (NISSENS)						400 678 32
			CARISMA DA 1,8	1731 2A	G	A		5/95-	
			CARISMA DA 1.6	1597 1A	G	A		6/95-	
			SPASE STARE 1,3i 16V	4G13					
			SPASE STARE 1,6i 16V	4G16					
			SPASE STARE 1,8i 16V	4G18					
			SPASE STARE 1,8i 16V	4G93					
									
МВLAN04-912	MR968857/MR968858	62894	LANCER '04- РАДИАТОР ОХЛАЖДЕНИЯ (NISSENS)						375 688 16
			LANCER 1,3i 16V	4G13	G	M/A	*	03/09-	
			LANCER 1,6i 16V	4G18	G	M/A	*	03/09-	
			LANCER 2,0i 16V	4G94	G	M/A	*	03/09-	
									
МВРАJ84-910	MB365155/6	62840	PAJERO '84-91 РАДИАТОР ОХЛАЖДЕН МТ 2.5 (турбодизель) (NISSENS)						425 598 33
			PAJERO 2300 TD L043G	4D55	D	M		9/84-4/86	
			PAJERO 2300 TD L043G	4D55	D	M		9/84-4/86	
			PAJERO 2500 TD L044G	4D56	D	M		5/86-10/89	
			PAJERO 2500 TD L049G	4D56	D	M		5/86-10/89	
			PAJERO 2500 TD L144G	4D56	D	M		11/89-4/91	
									
МВРАJ93-910	MB890954	62852	PAJERO '93- РАДИАТОР ОХЛАЖДЕН МТ 2.8 (турбодизель) (NISSENS)						500 628 42
			PAJERO 2800 TD V26W	4M40	D	M		7/93-	
			PAJERO 2800 TD V46W	4M40	D	M		7/93-	
									

№ФОРВАРДА	№ OEM	№ NISSENS	МОДЕЛЬ	ТИП ДВИГАТЕЛЯ	БЕН/Д ИЗ	ТИП КП	КОНД ИЦИ	ГОД	ПРИМЕЧА НИЕ
МВРАJ93-911	МВ890955	62853	РАJЕRО '93- РАДИАТОР ОХЛАЖДЕН АТ 2.8 (турбодизель) (NISSENS)						500 628 42
			РАJЕRО 2800 TD V26W	4M40	D	A		7/93-	
			РАJЕRО 2800 TD V46W	4M40	D	A		7/93-	
МBSWA94-910	МВ906097/МВ924249/54	62887	SPACE WAGON '92- {SPACE RUNNER/RVR} РАДИАТОР ОХЛАЖДЕН (NISSENS)						370 660 26
			1.8 i 16V SUMMIT WAGON (92-) 1.8 i 16V	4G63	G	M/A	+/-	01/94 > 00/00	
			1.8 i 16V SPACE RUNNER (91-) 1.8 i 16V	4G93	G	A	+/-	09/94 > 00/00	
			2.0 i 16V SPACE WAGON (92-) 2.0 i 16V	4G63	G	A	+/-	06/93 > 00/00	
MD10087-910	6315000502	62516	МВ100 '87-91 РАДИАТОР ОХЛАЖДЕН (NISSENS)						415 488 33
			LIGHT VAN MB 100 D 2,4 DIESEL	24000M616	D	M		9/87-6/91	
			LIGHT VAN MB 100 D 2,4 DIESEL	24000M616	D	M		6/91-	
MD12376-910	1235015601/1201/2901/3803/4003/5703/3603	62740	W123 '76-85 {W126 79-85} РАДИАТОР ОХЛАЖДЕН (NISSENS)						417 495 33
			W123 200	1997 115938/939	G	A	*/-	1/76-8/84	
			W123 200	1997 102920/939	G	A	*/-	9/80-12/85	
			W123 200D	1988 615940	D	A	*/-	1/76-11/85	
			W123 200T	1997 115938/939	G	A	*/-	9/80-11/85	
			W123 220D	2197 615941	D	A	*/-	1/76-8/84	
			W123 220D	2197 615941	D	M	*	1/76-8/84	
			W123 230	2299 115954/102980	G	A		1/76-8/84	
			W123 230C	2299 115920	G	A		3/77-8/80	
			W123 230CE	2299 115954/102980	G	A	*/-	9/80-12/85	
			W123 230E	2299 115954/102980	G	A	*/-	1/76-8/84	
			W123 230T	2299 115954	G	A		9/78-8/80	
			W123 230TE	2299 115954/102980	G	A	*/-	4/80-12/85	
			W123 240D	2399 616912	D	A	*/-	1/76-8/84	
			W123 240D	2399 616912	D	M	*	1/76-8/84	
			W123 240TD	2399 616912	D	A		6/78-11/85	
			W123 250	2525 123920/921	G	M	*	11/81-12/85	

№ФОРВАРДА	№ OEM	№ NISSENS	МОДЕЛЬ	ТИП ДВИГАТЕЛЯ	БЕН/Д ИЗ	ТИП КП	КОНД ИЦИ	ГОД	ПРИМЕЧА НИЕ
			W123 250	2525 123920/921	G	A	*	11/81-12/85	
			W123 250T	2525 123920/921	G	A	*	11/81-11/85	
			W123 250TS	2525 123920/921	G	A	*	9/83-8/84	
			W123 280	2746 110923/84/88	G	A	*/-	1/76-8/84	
			W123 280C	2746 110923/84/88	G	A	*/-	1/76-8/84	
			W123 280CE	2746 110923/84/88	G	A	*/-	1/76-8/84	
			W123 280E	2746 110923/84/88	G	A	*/-	1/76-8/84	
			W123 280TE	2746 110923/84/88	G	A	*/-	1/76-8/84	
			W123 300D	3005 617912	D	A		1/76-11/85	
			W123 300TD	2998 617952	D	A		8/79-11/85	
			W126 280SE	2746 110987/989	G	A	*/-	9/79-8/85	
			W126 280SEL	2746 110987/989	G	A	*/-	9/79-8/85	

MD12484-910 2015002903 62650 W124 '84-92 РАДИАТОР ОХЛАЖДЕН (NISSENS) 410 370 42

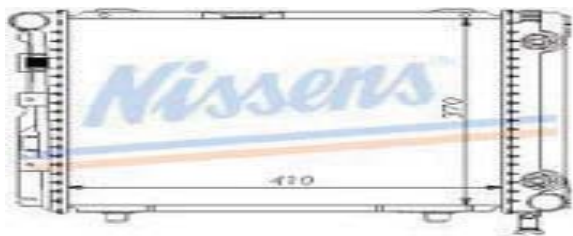

W124 200CE	1998M111	G	A	—	9/84-8/92
W124 200CE	1996M102	G	A	—	9/84-8/92
W124 200E	1996M102	G	A	—	9/84-8/92
W124 200TE	1998M111	G	A	—	9/84-8/92
W124 200TE	1996M102	G	A	—	9/84-8/92
W124 230CE	2298M102	G	A	—	9/84-8/92
W124 230E	2298M102	G	A	—	9/84-8/92
W124 230TE	2298M102	G	A	—	9/84-8/92

MD12484-911 1245001503/1403 62711 W124 '84-95 РАДИАТОР ОХЛАЖДЕН (NISSENS) 450 370 42

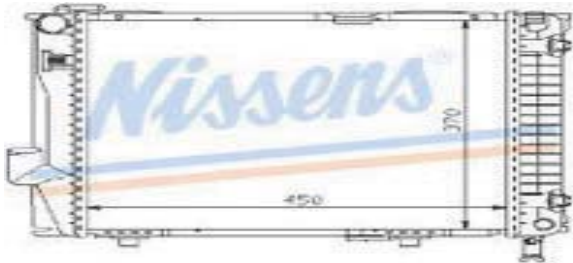

MD12485-910 1245001503/1403 62711 W124 '84-95 РАДИАТОР ОХЛАЖДЕН 450 370 42



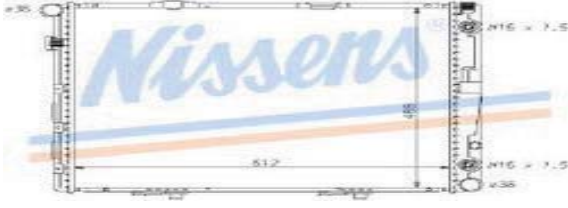

W124 260E	2597M103	G	MA	—	9/84-6/93
W124 260E 4MATIC	2597M103	G	MA	—	9/84-6/93
W124 280E	2799M104	G	MA	—	8/92-6/93
W124 280TE	2799M104	G	MA	—	8/92-6/93
W124 300 TE	2962M103	G	MA	—	6/85-6/93
W124 300CE	2962M103	G	MA	—	9/84-6/93
W124 300E	2962M103	G	MA	—	9/84-6/93
W124 300E 24V	2962M104	G	MA	—	9/89-6/93
W124 300E 4MATIC	2962M103	G	MA	—	9/84-6/93
W124 300E CABRIO	2962M104	G	MA	—	5/92-6/93
W124 300TE 4MATIC	2962M103	G	MA	—	6/85-6/93
W124 320CE	3199M104	G	MA	—	6/93-6/95
W124 320E	3199M104	G	MA	—	6/93-6/95
W124 320TE	3199M104	G	MA	—	6/93-6/95
W124 E 280	2799M104	G	MA	—	8/92-6/95
W124 E 280T	2799M104	G	MA	—	6/93-6/95
W124 E 320	3199M104	G	MA	—	6/93-6/95
W124 E 320 4MATIC	3199M104	G	MA	—	6/93-6/95
W124 E 320 CABRIO	3199M104	G	MA	—	6/93-6/95
W124 E 320 COUPE	3199M104	G	MA	—	6/93-6/95
W124 E 320T	3199M104	G	MA	—	6/93-6/95
W124 E 320T 4MATIC	3199M104	G	MA	—	6/93-6/95

№ФОРВАРДА	№ OEM	№ NISSENS	МОДЕЛЬ	ТИП ДВИГАТЕЛЯ	БЕН/Д ИЗ	ТИП КП	КОНД ИЦИ	ГОД	ПРИМЕЧА НИЕ
MD12484-912	1245000403/2303/1202/4903	62549A	W124 '84-93 РАДИАТОР ОХЛАЖДЕН (NISSENS)						532 370 32
MD12485-912	1245000403/2303/1202/4903	62549	W124 '84-93 РАДИАТОР ОХЛАЖДЕН						532 370 32
			W124 200D	1997OM601	D	M		9/84-6/93	
			W124 200TD	1997OM601	D	M		9/84-6/93	
			W124 250D	2497OM602	D	M		9/84-12/89	
			W124 250TD	2497OM602	D	M		1/85-12/89	
			W124 E 200D	1997OM601	D	M	—	4/84-	
MD12484-913	1245002303/0503	62557A	W124 '84-93 РАДИАТОР ОХЛАЖДЕН (NISSENS)						530 370 42
			W124 200D	1997OM601	D	A		9/84-6/93	
			W124 200TD	1997OM601	D	A		9/84-4/90	
			W124 250D	2497OM602	D	A		9/84-12/89	
			W124 250TD	2497OM602	D	A		1/85-12/89	
			W124 E 200D	1997OM601	D	A	—	9/84-4/90	
MD12484-914	1245009003/2803	62683A	W124 '84-95 РАДИАТОР ОХЛАЖДЕН (NISSENS)						532 490 40
			W124 260E	2597M103	G	A	*	9/84-6/93	
			W124 260E 4MATIC	2597M103	G	A	*	9/84-6/93	
			W124 280E	2799M104	G	A	*	8/92-6/93	
			W124 280TE	2799M104	G	A	*	8/92-6/93	
			W124 300CE	2962M103	G	A	*	9/84-6/93	
			W124 300E	2962M103	G	A	*	9/84-6/93	
			W124 300E 24V	2962M104	G	A	*	9/89-6/93	
			W124 300E 4MATIC	2962M103	G	A	*	9/84-6/93	
			W124 300E CABRIO	2962M104	G	A	*	5/92-6/93	
			W124 300TE	2962M103	G	A	*	6/85-6/93	
			W124 300TE 4MATIC	2962M103	G	A	*	4/86-6/93	
			W124 320CE	3199M104	G	MA	*	10/92-6/93	
			W124 320E	3199M104	G	MA	*	10/92-6/93	
			W124 320TE	3199M104	G	MA	*	10/92-6/93	
			W124 E 280	2799M104	G	A	*	8/92-6/95	
			W124 E 280T	2799M104	G	MA	*	8/92-6/95	
			W124 E 320	3199M104	G	A	*	6/93-6/95	
			W124 E 320 4MATIC	3199M104	G	MA	*	6/93-6/95	
			W124 E 320 CABRIO	3199M104	G	MA	*	6/93-6/95	
			W124 E 320 COUPE	3199M104	G	MA	*	6/93-6/95	
			W124 E 320T	3199M104	G	MA	*	6/93-6/95	
			W124 E 320T 4MATIC	3199M104	G	MA	*	6/93-6/95	

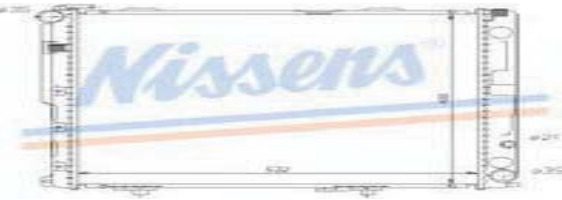

№ФОРВАРДА	№ OEM	№ NISSENS	МОДЕЛЬ	ТИП ДВИГАТЕЛЯ	БЕН/Д ИЗ	ТИП КП	КОНД ИЦИ	ГОД	ПРИМЕЧА НИЕ
MD12484-915	1245002703/8903	62684A	W124 '84-93 РАДИАТОР ОХЛАЖДЕН (NISSENS)						532 490 40
			W124 260E	2597M103	G	M	*	9/84-6/93	
			W124 260E 4MATIC	2597M103	G	M	*	9/84-6/93	
			W124 280E	2799M104	G	M	*	8/92-6/93	
			W124 280TE	2799M104	G	M	*	8/92-6/93	
			W124 300CE	2962M103	G	M	*	9/84-6/93	
			W124 300E	2962M103	G	M	*	9/84-6/93	
			W124 300E 24V	2962M104	G	M	*	9/89-6/93	
			W124 300E 4MATIC	2962M103	G	M	*	9/84-6/93	
			W124 300E CABRIO	2962M104	G	M	*	5/92-6/93	
			W124 300TE	2962M103	G	M	*	6/85-6/93	
			W124 300TE 4MATIC	2962M103	G	M	*	6/85-6/93	
			W124 E 280	2799M104	G	M	*	8/92-6/95	
			W124 E 320	3199M104	G	M	*	6/93-6/95	
MD12484-916	1245009203/2103	62693A	W124 '84-93 РАДИАТОР ОХЛАЖДЕН (NISSENS)						532 490 32
			W124 200D	1997OM601	D	M	*	1/90-6/93	
			W124 200TD	1997OM601	D	M	*	1/90-6/93	
			W124 250D	2497OM602	D	M	*	1/90-6/93	
			W124 250D	2497OM602	D	M	*	9/84-6/93	
			W124 250TD	2497OM602	D	M	*	9/84-6/93	
			W124 250TD	2497OM602	D	M	*	1/90-6/93	
			W124 E 200D	1997OM601	D	M	*	9/84-	
			MD12484-917	1245009503/2103/0903	62697A	W124 '84-95 РАДИАТОР ОХЛАЖДЕН (NISSENS)			
			W124 200D	1997OM601	D	M	*	9/84-12/89	
			W124 200TD	1997OM601	D	M	*	9/84-12/89	
			W124 300D	2996OM603	D	M	*/-	9/84-6/93	
			W124 300D 4MATIC	2996OM606	D	M	*/-	9/84-6/93	
			W124 E 250TD	2497OM602	D	M	*/-	6/88-6/95	
MD12484-918	1245009803/2203/1003/4403	62698A	W124 '84-95 РАДИАТОР ОХЛАЖДЕН (NISSENS)						532 490 40
MD12485-911	1245009803/2203/1003/4403	62698	W124 '84-85 РАДИАТОР ОХЛАЖДЕН						532 490 40
			W124 200D	1997OM601	D	A	*	9/84-12/89	
			W124 200TD	1997OM601	D	A	*	9/84-12/89	
			W124 250D	2497OM602	D	A	*	9/84-6/93	
			W124 250TD	2497OM602	D	A	*	9/84-6/93	
			W124 300D	2996OM603	D	A	*/-	9/84-6/93	
			W124 300D 4MATIC	2996OM606	D	A	*/-	9/84-6/93	
			W124 E 200D	1997OM601	D	A	*	9/84-	
W124 E 250TD	2497OM602	D	A	*/-	6/88-6/95				

№ФОРВАРДА	№ OEM	№ NISSENS	МОДЕЛЬ	ТИП ДВИГАТЕЛЯ	БЕН/Д ИЗ	ТИП КП	КОНД ИЦИ	ГОД	ПРИМЕЧА НИЕ
MD12484-919	1245000103	62748A	W124 '84-95 РАДИАТОР ОХЛАЖДЕН (NISSENS)						488 488 42
MD12485-913	1245000103	62748	W124 '84-'85 РАДИАТОР ОХЛАЖДЕН (NISSENS)						488 488 40
			W124 200	1996M102	G	M	*	9/84-3/90	
			W124 200CE	1998M111	G	M	*	9/84-8/95	
			W124 200CE	1996M102	G	M	*	9/84-8/95	
			W124 200E	1996M102	G	M	*	9/84-8/92	
			W124 200T	1996M102	G	M	*	9/84-3/90	
			W124 200TE	1998M111	G	M	*	9/84-8/95	
			W124 200TE	1996M102	G	M	*	9/84-8/95	
			W124 230CE	2298M102	G	M	*	9/84-8/92	
			W124 230E	2298M102	G	M	*	9/84-8/92	
			W124 230TE	2298M102	G	M	*	9/84-8/92	
MD12486-910	1245000002/3103/3203	62695A	W124 '86-95 РАДИАТОР ОХЛАЖДЕН (NISSENS)						610 490 42
			W124 300TD	2996OM603	D	MA	*/-	1/86-6/93	
			W124 300TD 4MATIC	2996OM603	D	MA	*/-	1/86-6/93	
			W124 E 300TD	2996OM603	D	A	*	6/93-6/95	
MD12490-910	1245009303	62694A	W124 '90-93 РАДИАТОР ОХЛАЖДЕН (NISSENS)						532 490 32
			W124 200D	1997OM601	D	A	*	1/90-6/93	
			W124 200TD	1997OM601	D	A	*	1/90-6/93	
			W124 250D	2497OM602	D	A		1/90-6/93	
			W124 250TD	2497OM602	D	A		1/90-6/93	
			W124 E 200D	1997OM601	D	A	—	4/90-	
MD12492-910	1245006003/5903	62659	W124 '92-95 РАДИАТОР ОХЛАЖДЕН (NISSENS)						410 378 32
			W124 E 220	2199M111	G	MA	—	8/92-6/95	
			W124 E 220 CABRIO	2199M111	G	MA	—	8/92-6/95	
			W124 E 220 COUPE	2199M111	G	MA	—	8/92-6/95	
			W124 E 220T	2199M111	G	MA	—	8/92-6/95	

№ ФОРВАРДА	№ OEM	№ NISSENS	МОДЕЛЬ	ТИП ДВИГАТЕЛЯ	БЕН/Д ИЗ	ТИП КП	КОНД ИЦИ	ГОД	ПРИМЕЧА НИЕ
MD12492-911	1245006303/6202	62763A	W124 '92-95 РАДИАТОР ОХЛАЖДЕН (NISSENS)						488 488 40
			W124 E 200	1998 111940	G	A	*	8/92-6/95	
			W124 E 200 CABRIO	1998M111	G	MA	*	8/92-6/95	
			W124 E 200T	1998M111	G	MA	*	8/92-6/95	
			W124 E 220	2199M111	G	A	*	8/92-6/95	
			W124 E 220 CABRIO	2199M111	G	MA	*	8/92-6/95	
			W124 E 220 COUPE	2199M111	G	MA	*	8/92-6/95	
			W124 E 220T	2199M111	G	MA	*	8/92-6/95	
MD12492-912	1245006203	62764A	W124 '92-95 РАДИАТОР ОХЛАЖДЕН (NISSENS)						488 488 40
			W124 E 200	1998 111940	G	M	*	8/92-6/95	
			W124 E 220	2199M111	G	M	*	8/92-6/95	
MD12492-913	1245005603/7103	62658	W124 '92-94 РАДИАТОР ОХЛАЖДЕН (NISSENS)						292 348 42
			W124 E 200 CABRIO	1998M111	G	MA	—	8/92-6/95	
			W124 E 200 COUPE	1998M111	G	MA	—	8/92-6/95	
			W124 E 200 COUPE	1998 111940	G	MA	—	8/92-6/95	
			W124 E 200T	1998M111	G	MA	—	8/92-6/95	
MD12493-910	1245007603/1902	62696A	W124 '93-95 РАДИАТОР ОХЛАЖДЕН (NISSENS)						532 490 40
			W124 E 250D	2497OM602	D	M	*/-	6/93-	
			W124 E 300D	2998OM606	D	M	—	7/93-	

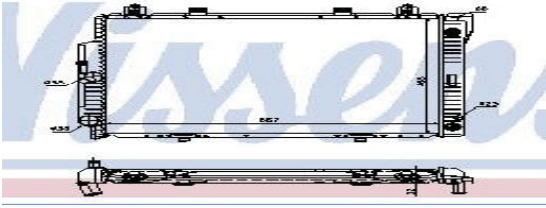
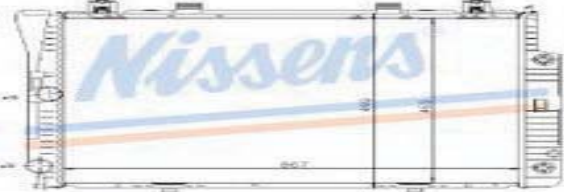
№ФОРВАРДА	№ OEM	№ NISSENS	МОДЕЛЬ	ТИП ДВИГАТЕЛЯ	БЕН/Д ИЗ	ТИП КП	КОНД ИЦИ	ГОД	ПРИМЕЧА НИЕ
MD12493-911	1245007803/2002/9803/1802/7603	62699A	W124 '93-95 РАДИАТОР ОХЛАЖДЕН (NISSENS)						532 490 40
			W124 250D	24970M602	D	M	*/-	6/93-6/95	
			W124 250D	24970M602	D	A	*/-	6/93-6/95	
			W124 E 250D	24970M602	D	A	*/-	6/93-	
			W124 E 300D	29980M606	D	A	—	7/93-	
									
MD12493-912	1245008103/2202/2302	62762A	W124 '93-95 РАДИАТОР ОХЛАЖДЕН (NISSENS)						610 490 42
			W124 E 300D	29980M606	D	MA	*	6/93-	
									
MD12681-910	1265004803/3303/0103/1103/1803	62727A	W126 '81-91 РАДИАТОР ОХЛАЖДЕН (NISSENS)						426 669 40
MD12681-911	1265004803/3303/0103/1103/1803	62727A	W126 '81-91 РАДИАТОР ОХЛАЖДЕН						426 669 40
			W126 380SE	3839 116963	G	A	*	9/81-8/85	
			W126 380SE	3839 116963	G	A		9/81-4/82	
			W126 380SEC	3839 116963	G	A		9/81-4/82	
			W126 380SEC	3839 116963	G	A	*	9/81-9/85	
			W126 380SEL	3839 116963	G	A	*	9/81-9/85	
			W126 380SEL	3839 116963	G	A		9/81-4/82	
			W126 420SE	4200 116965	G	A	*	9/85-2/91	
			W126 420SEC	4200 116965	G	A	*	9/85-2/91	
			W126 420SEL	4200 116965	G	A	*	9/85-2/91	
			W126 500SE	4973 117963/117965	G	A	*	9/81-2/91	
			W126 500SEC	4973 117965/117963	G	A	*	9/81-2/91	
			W126 500SEL	4973 117965/117963	G	A	*	9/81-2/91	
			W126 560SE	5547 117968	G	A	*	9/85-2/91	
			W126 560SEC	5547 117968	G	A	*	9/85-2/91	
			W126 560SEL	5547 117968	G	A	*	9/85-2/91	
MD12685-910	1265004003	62704A	W126 '85-91 РАДИАТОР ОХЛАЖДЕН (NISSENS)						487 488 42
			W126 260SE	2597 130941	G	M	*/-	9/85-2/91	
			W126 300SE	2960 116961/963	G	M	*/-	9/85-2/91	
			W126 300SEL	2960 116961/963	G	M	*/-	9/85-2/91	
									

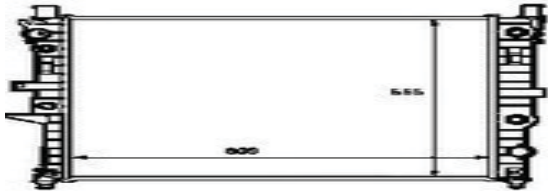
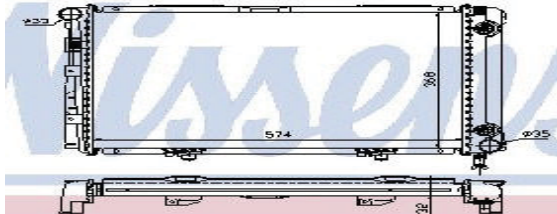

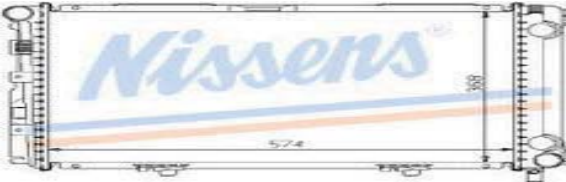
№ФОРВАРДА	№ OEM	№ NISSENS	МОДЕЛЬ	ТИП ДВИГАТЕЛЯ	БЕН/Д ИЗ	ТИП КП	КОНД ИЦИ	ГОД	ПРИМЕЧА НИЕ
MD14090-910	1405001403/1003/1603	62716A	W140 '90-'99 РАДИАТОР ОХЛАЖДЕН (NISSENS)						667 469 40
MD14090-911	1405001403/1003/1603	62716	W140 '90-'99 РАДИАТОР ОХЛАЖДЕН						667 469 40
			W140 400SE	4196M119	G	A	*/-	9/90-	
			W140 400SEL	4196M119	G	A	*/-	9/90-	
			W140 500SE	4973M119	G	A	*/-	9/90-	
			W140 500SEC	4973M119	G	A	*/-	9/90-	
			W140 500SEL	4973M119	G	A	*/-	9/90-	
			W140 600SE	5991M120	G	A	*	9/90-	
			W140 600SEC	5987M120	G	A	*	9/90-	
			W140 600SEL	5991M120	G	A	*	9/90-	
			W140 S 420	4196M119	G	A	*/-	9/90-	
			W140 S 420 COUPE	4196M119	G	A	*/-	2/91-	
			W140 S 500	4973M119	G	A	*/-	1/93-	
			W140 S 500 COUPE	4973M119	G	A	*/-	1/93-1/99	
			W140 S 600	5987M120	G	A	*	1/93-	
			W140 S 600 COUPE	5987M120	G	A	*	1/93-	
MD14091-910	1405000403/0303	62713A	W140 '91-'92 РАДИАТОР ОХЛАЖДЕН (NISSENS)						670 468 32
MD14091-911	1405000403/0303	62713	W140 '91-'92 РАДИАТОР ОХЛАЖДЕН						667 468 32
			S-CLASS W 140 (91-) 300 SE/SEL	M104.990/M104.994	G	M/A	+/-	02/91 - 12/92	
									
MD14092-910	1405002103	62746A	W140 '92-'99 РАДИАТОР ОХЛАЖДЕН (NISSENS)						667 468 32
			W140 300SE	3199M104	G	MA	*/-	12/92-/00	
			W140 300SE	2799M104	G	MA	*/-	12/92-	
			W140 300SEL	3199M104	G	MA	*/-	12/92-	
			W140 S 320	3199M104	G	A	*/-	7/93-	
									

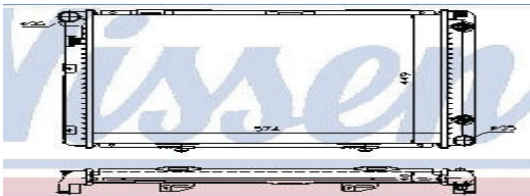
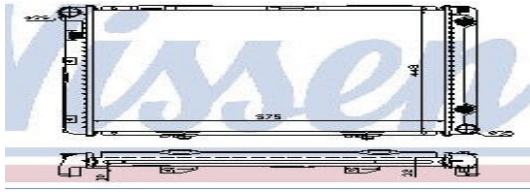
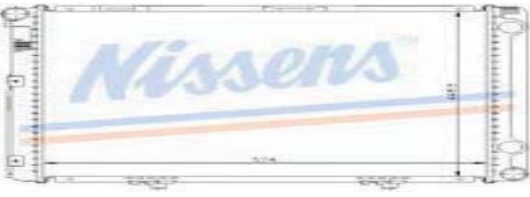
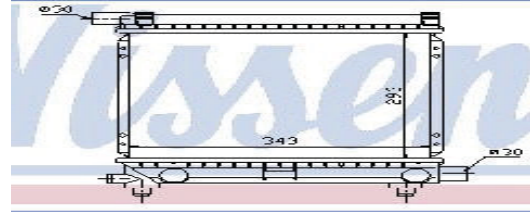
№ФОРВАРДА	№ OEM	№ NISSENS	МОДЕЛЬ	ТИП ДВИГАТЕЛЯ	БЕН/Д ИЗ	ТИП КП	КОНД ИЦИ	ГОД	ПРИМЕЧА НИЕ
MD16397-910	163500003/1635000404/1635002204	62788A	W163/ML '97-РАДИАТОР ОХЛАЖДЕНИЯ (NISSENS)						609 555 30
			W 163 ML 230	M111 977	G	M/A	*/-	97/9-	
			W 163 ML 320	M 112 942	G	M/A	*/-	97/9-	
			W 163 ML 350	M112 970	G	M/A	*/-	02/8-	
			W 163 ML 430	M113 942	G	M/A	*/-	97/9-	
			W 163 ML 500	M113 965	G	M/A	*/-	01/9-	
			W 163 ML 55 AMG	M113 981	G	M/A	*/-	00/2-	
									
MD20181-910	2015004203/4103	62670A	W201 '81-93 РАДИАТОР ОХЛАЖДЕН (NISSENS)						575 368 32
MD20181-911		62670	W201 '81-93 РАДИАТОР ОХЛАЖДЕН						574 368 32
			190 W 201 (82-) 190	M 102	G	A	+	09/83 - 08/93	
			190 W 201 (82-) 190 E 2.0	M 102	G	A	+	09/82 - 08/93	
			190 W 201 (82-) 190 D 2.0	M601.911	D	A	-	09/83 - 08/93	
			190 W 201 (82-) 190 D 2.2	M601.911	D	A	-	09/83 - 08/93	
			C-CLASS W 201 (82-) 190	M 102	G	A	+	09/83 - 08/93	
			C-CLASS W 201 (82-) 190 E 2.0	M 102	G	A	+	09/82 - 08/93	
			C-CLASS W 201 (82-) 190 D 2.0	M601.911	D	A	-	09/83 - 08/93	
			C-CLASS W 201 (82-) 190 D 2.2	M601.911	D	A	-	09/83 - 08/93	
									
MD20182-910	2015004603/7603/3803/4003/0603	62550	W201 '82-93 {W124 84-90} РАДИАТОР ОХЛАЖДЕН (NISSENS)						292 344 52
			W124 200	1996M102	G	A	—	9/84-3/90	
			W124 200T	1996M102	G	A	—	9/84-3/90	
			W201 190	1996M102	G	A	—	8/82-10/86	
			W201 190E	1996M102	G	A	—	11/86-8/93	
			W201 190E	1996M102	G	A	—	8/82-10/86	
			W201 190E 1,8	1996M102	G	A	—	11/86-8/93	
			W201 190E 2,0	1797M102	G	A	—	7/89-8/93	
			W201 190E 2,0	1996 102961/962	G	A	*	9/82-	
			W201 190E 2,0	1996 102964/67	G	M	*	3/85-12/86	
			W201 190E 2,0	1996 102964/67	G	A	*	3/85-12/86	
									
MD20182-911	2015000803/1903	62671A	W201 '82-93 РАДИАТОР ОХЛАЖДЕН (NISSENS)						575 368 32
MD20185-914	2015000803/1903	62671	W201 '82-93 РАДИАТОР ОХЛАЖДЕН						577 368 32
			W201 190	1996M102	G	M	*	8/82-8/93	
			W201 190D 2,0	1997OM601	D	M	*/-	9/83-8/93	
			W201 190E	1996M102	G	M	*	8/82-8/93	
			W201 190E 2,0	1996 102961/962	G	M	*	9/82-	
			W201 190E 2,0	1996 102964/67	G	M	*	3/85-12/86	
									

№ФОРВАРДА	№ OEM	№ NISSENS	МОДЕЛЬ	ТИП ДВИГАТЕЛЯ	БЕН/Д ИЗ	ТИП КП	КОНД ИЦИ	ГОД	ПРИМЕЧА НИЕ
MD20182-912	2015005503/1703/4403/8303/8103	62721A	W201 '82-93 РАДИАТОР ОХЛАЖДЕН (NISSENS)						574 449 40
MD20182-918		62721	W201 '82-93 РАДИАТОР ОХЛАЖДЕН						574 449 40
			W201 190D 2,0	19970M601	D	A	*	9/83-8/93	USA
			W201 190D 2,2	2199	D	A	*	1/86-	
			W201 190E	1996M102	G	A	*	8/82-8/93	HD
			W201 190E 1,8	1797M102	G	A	*	7/89-8/93	
									
MD20182-913	2015002203/8103/1203/4303/2103	62722A	W201 '82-93 РАДИАТОР ОХЛАЖДЕН (NISSENS)						574 449 32
MD20182-917	2015002203/8103/1203/4303/2103	62722	W201 '82-93РАДИАТОР ОХЛАЖДЕН						574 449 32
			W201 190D 2,2	2199	D	A		1/86-	
			W201 190E	1996M102	G	A	*	8/82-8/93	
			W201 190E 2,3	2299M102	G	A	*	10/84-8/93	
			W201 190E 2,3	2299M102	G	A	*	6/86-8/93	USA-J
									
MD20182-914	2015002203/8103	62732A	W201 '82-93 РАДИАТОР ОХЛАЖДЕН (NISSENS)						574 449 32
			W201 190E	1996M102	G	M	*	8/82-8/93	
			W201 190E 2,3	2299M102	G	M	*	10/84-10/92	
									
MD20182-915	2015007603/3703/0503/5703//1245008303	62551	W201 '82-93 РАДИАТОР ОХЛАЖДЕН (NISSENS)						293 343 42
MD20182-919	2015007603/3703/0503/5703//1245008303	62551	W201 '82-93РАДИАТОР ОХЛАЖДЕН						293 343 42
			W124 200	1996M102	G	M	—	9/84-3/90	
			W124 200CE	1998M111	G	M	—	9/84-8/92	
			W124 200CE	1996M102	G	M	—	9/84-8/92	
			W124 200E	1996M102	G	M	—	9/88-6/93	
			W124 200T	1996M102	G	M	—	9/84-3/90	
			W124 200TE	1998M111	G	M	—	9/84-8/92	
			W124 200TE	1996M102	G	M	—	9/84-8/92	
			W124 230CE	2298M102	G	M	—	9/84-8/92	
			W124 230E	2298M102	G	M	—	9/84-8/92	
			W124 230TE	2298M102	G	M	—	9/84-8/92	
			W201 190	1996 102921	G	M	—	8/82-10/86	
			W201 190	1996M102	G	M	—	8/82-10/86	
			W201 190	1996M102	G	M	—	11/86-8/93	
			W201 190E	1996M102	G	M	—	8/82-10/86	
			W201 190E	1996M102	G	M	—	11/86-8/93	
			W201 190E 1,8	1797M102	G	M	—	7/89-8/93	
			W201 190E 2,0	1996 102961/962	G	M	—	9/82-	
			W201 190E 2,3	2299M102	G	M	—	10/84-8/93	
									

№ФОРВАРДА	№ OEM	№ NISSENS	МОДЕЛЬ	ТИП ДВИГАТЕЛЯ	БЕН/Д ИЗ	ТИП КП	КОНД ИЦИ	ГОД	ПРИМЕЧА НИЕ
MD20182-916	2015001803	62731A	W201 '82-93 РАДИАТОР ОХЛАЖДЕН (NISSENS)						574 449 40
			W201 190D 2,0	1996OM601	D	M	*	9/83-8/93	USA
			W201 190D 2,2	2199	D	M	*	9/83-	
			W201 190E	1996M102	G	M	*	8/82-8/93	HD
									
MD20185-910	2015002803/3303/3403	62728	W201 '85-93 РАДИАТОР ОХЛАЖДЕН (NISSENS)						487 448 33
			W201 190E 2,3	2299M102	G	A	*	6/86-8/93	
			W201 190E 2,3 16V	2299M102	G	A	*	9/85-8/88	
			W201 190E 2,5 16V	2463M102	G	A	*	10/88-8/93	
									
MD20185-911	2015008003/3503/1103	62729	W201 '85-93 РАДИАТОР ОХЛАЖДЕН (NISSENS)						487 448 33
			W201 190E 1,8	1797M102	G	M	*	7/89-8/93	
			W201 190E 2,3	2299M102	G	M	*	6/86-	
			W201 190E 2,3 16V	2299M102	G	M	*	9/85-8/88	
			W201 190E 2,5 16V	2463M102	G	M	*	10/88-8/93	
									
MD20185-912	2015008603/8503	62734A	W201 '85-93 РАДИАТОР ОХЛАЖДЕН (NISSENS)						574 449 32
			W201 190D 2,5	2497OM602	D	MA	*/-	5/85-8/93	
									

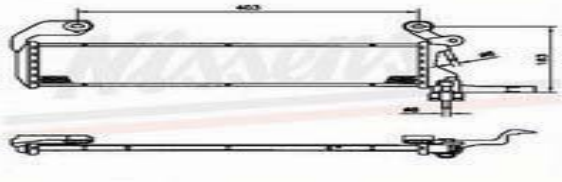
№ ФОРВАРДА	№ OEM	№ NISSENS	МОДЕЛЬ	ТИП ДВИГАТЕЛЯ	БЕН/Д ИЗ	ТИП КП	КОНД ИЦИ	ГОД	ПРИМЕЧА НИЕ			
MD20293-913	2025002203/6703	62756A	W202 '93-00 РАДИАТОР ОХЛАЖДЕН (NISSENS)						615 422 32			
			R 170 SLK 200	1998M111	G	M	*	4/96-				
			R 170 SLK 200	1998M111	G	A	*	4/96-				
			R 170 SLK 200 КОМПРЕССОР	1998M111	G	M	*	4/96-				
			R 170 SLK 200 КОМПРЕССОР	1998M111	G	A	*	4/96-				
			R 170 SLK 230 КОМПРЕССОР	2295M111	G	A	*	4/96-				
			R 170 SLK 230 КОМПРЕССОР	2295M111	G	M	*	4/96-				
			W202 C 180	1799M111	G	A	*	6/93-				
			W202 C 180 T-MODEL	1799M111	G	A	*	6/93-				
			W202 C 200 T-MODEL	1998M111	G	A	*	1/94-				
			W202 C 220	2199M111	G	A	*	6/93-				
			W202 C 240	2397M112	G	A	*	1/97-				
			W202 C 240 T-MODEL	2397M112	G	A	*	1/97-				
			W202 C 200	1998M111	G	A	*	6/93-				
			W208 CLK 200	1998	G	M	*	3/97-				
			MD20293-914	2025004103	62739A	W202 '93-00 РАДИАТОР ОХЛАЖДЕН (NISSENS)						615 420 40
						W202 C 280	2799M112	G	MA	*/-	6/93-	
W202 C 280 T-MODEL	2799M112	G				MA	*/-	6/93-				
MD20293-915	2025006103/2603/5803/59036003	62708A	W202 '93-00 РАДИАТОР ОХЛАЖДЕН (NISSENS)						360 436 33			
			W202 C 180	1799M111	G	MA	—	3/93-				
			W202 C 180 T-MODEL	1799M111	G	MA	—	3/93-				
			W202 C 200	1998M111	G	MA	—	6/93-				
			W202 C 200 T-MODEL	1998M111	G	MA	—	1/94-				
			W202 C 220	2199M111	G	MA	—	6/93-				
			W202 C 230	2295M111	G	A	—	3/96-				
			W202 C 230 T-MODEL	2295M111	G	A	—	3/96-				
			W208 CLK 200	1998	G	M	—	3/97-				
			W210 E 200	1998M111	G	MA	—	7/95-				
			W210 E 200 T-MODEL	1998M111	G	MA	—	7/95-				
			W210 E 230	2295M111	G	MA	—	7/95-				
W210 E 230 T-MODEL	2295M111	G	MA	—	7/95-							
MD20295-910	2025005203	62712	W202 '95-00 РАДИАТОР ОХЛАЖДЕН (NISSENS)						520 418 0			
			W202 C 200 КОМПР. T-MODEL	1998M111	G	MA	*/-	4/95-				
			W202 C 200 КОМПРЕССОР	1998M111	G	MA	*/-	4/95-				
			W202 C 230 КОМПР. T-MODEL	2295M111	G	MA	*/-	4/95-				
			W202 C 230 КОМПРЕССОР	2295M111	G	MA	*/-	4/95-				

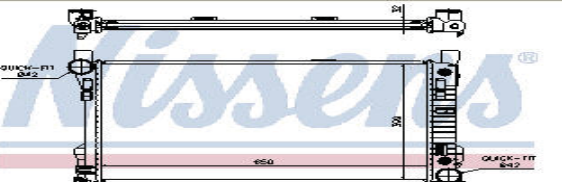
№ФОРВАРДА	№ OEM	№ NISSENS	МОДЕЛЬ	ТИП ДВИГАТЕЛЯ	БЕН/Д ИЗ	ТИП КП	КОНД ИЦИ	ГОД	ПРИМЕЧА НИЕ
MD20297-910	2025007903/6903	62761	W202 '97-00 РАДИАТОР ОХЛАЖДЕН (NISSENS)						400 91 0
			W202 C 200 CDI	21510M611	D	MA	*/-	7/97-5/00	
			W202 C 200 CDI T-MODEL	21510M611	D	MA	*/-	7/97-	
			W202 C 220 CDI	21510M611	D	MA	*/-	7/97-	
			W202 C 220 CDI T-MODEL	21510M611	D	MA	*/-	7/97-	
									
MD20297-911	2025006403	62618	W202 '97-00 РАДИАТОР ОХЛАЖДЕН (NISSENS)						615 422 0
			W202 C 200 CDI	21510M611	D	A	*	10/97-5/00	
			W202 C 200 CDI T-MODEL	21510M611	D	A	*	10/97-	
			W202 C 220 CDI	21510M611	D	A	*	1/98-	
			W202 C 220 CDI T-MODEL	21510M611	D	A	*	1/98-	
									
MD20298-910	2025006303	62617	W202 '98-00 РАДИАТОР ОХЛАЖДЕН (NISSENS)						615 422 0
			W202 C 200 CDI	21510M611	D	M	*	1/98-5/00	
			W202 C 200 CDI T-MODEL	21510M611	D	M	*	1/98-	
			W202 C 220 CDI	21510M611	D	M	*	1/98-	
			W202 C 220 CDI T-MODEL	21510M611	D	M	*	1/98-	
									
MD20300-910	2035000303/0603/1103/0503/0603/0703/1003	62786A	W203 00- {+ W209 02- / W171 04-} РАДИАТОР ОХЛАЖДЕН (NISSENS)						650 399 32
			C-CLASS W 203 160 KOMPRESSOR	M271.946	G	M/A	+/-	05/00 -	
			C-CLASS W 203 180	M111.951	G	M/A	+/-	09/00 -	
			C-CLASS W 203 180 KOMPRESSOR	M271.946	G	M/A	+/-	05/00 -	
			C-CLASS W 203 200 CDI	M611.962	D	M/A	+/-	04/00 -	
			C-CLASS W 203 200 CGI	M271.942	G	M/A	+/-	05/00 -	
			C-CLASS W 203 200 CGI KOMPR.	M271.942	G	A	+/-	05/00 -	
			C-CLASS W 203 200 KOMPRESSOR	M111.955	G	M/A	+/-	05/00 -	
			C-CLASS W 203 220 CDI	M611.962	D	M/A	+/-	04/00 -	
			C-CLASS W 203 230	M272.920	G	M/A	+/-	04/00 -	
			C-CLASS W 203 230 KOMPRESSOR	M271.948	G	A	+/-	05/00 -	
			C-CLASS W 203 240	M112.946	G	M/A	+/-	04/00 -	
			C-CLASS W 203 240 4-MATIC	M112.946	G	M/A	+/-	04/00 -	
			C-CLASS W 203 280	M272.940	G	A	+/-	04/00 -	
			C-CLASS W 203 280 4-MATIC	M272.940	G	A	+/-	04/00 -	
			C-CLASS W 203 30 CDI AMG	M612.990	D	M/A	+	05/00 -	
			C-CLASS W 203 32 AMG KOMP	M112.961	G	A	+/-	04/00 -	
			C-CLASS W 203 320	M112.946	G	A	+/-	04/00 -	
			C-CLASS W 203 320 4-MATIC	M112.946	G	A	+/-	04/00 -	
			C-CLASS W 203 350	M272.960	G	A	+/-	04/00 -	
			C-CLASS W 203 350 4-MATIC	M272.960	G	A	+/-	04/00 -	
			C-CLASS W 203 36 AMG	M272.940	G	A	+/-	04/00 -	
			C-CLASS W 203 55 AMG	M113.988	G	A	+/-	04/00 -	
			CLK-CLASS W 209 200 CGI	M271.942	G	M/A	+/-	06/02 -	
			CLK-CLASS W 209 200 KOMPR.	M271.940	G	M/A	+/-	06/02 -	
									

№ФОРВАРДА	№ OEM	№ NISSENS	МОДЕЛЬ	ТИП ДВИГАТЕЛЯ	БЕН/Д ИЗ	ТИП КП	КОНД ИЦИ	ГОД	ПРИМЕЧА НИЕ
			CLK-CLASS W 209 220 CDI	M646.963	D	M/A	+/-	06/02 -	
			CLK-CLASS W 209 240	M112.912	G	M/A	+/-	06/02 -	
			CLK-CLASS W 209 270 CDI	M612.962/M612.967	D	M/A	+/-	06/02 -	
			CLK-CLASS W 209 280	M272.940	G	M/A	+/-	06/02 -	
			CLK-CLASS W 209 300	M272.940	G	M/A	+/-	06/02 -	
			CLK-CLASS W 209 300	M112.955	G	M/A	+/-	06/02 -	
			CLK-CLASS W 209 350	M272.960	G	M/A	+/-	06/02 -	
			CLK-CLASS W 209 500	M113.968	G	M/A	+/-	06/02 -	
			CLK-CLASS W 209 55 AMG	M113.987	G	M/A	+	06/02 -	
			CLK-CLASS W 209 63 AMG	M156.982	G	M/A	+	06/02 -	
			SLK-CLASS W 171 200 KOMPR.	M271.944	G	M	+/-	03/04 -	
			SLK-CLASS W 171 200 KOMPR.	M271.944	G	A	+/-	03/04 -	
			SLK-CLASS W 171 280	M272.982	G	A	+/-	03/04 -	
			SLK-CLASS W 171 300	M272.942	G	A	+/-	03/04 -	
			SLK-CLASS W 171 350	M272.963	G	A	+/-	03/04 -	

MD21095-910 2105000903 62666A W210 '95- РАДИАТОР ОХЛАЖДЕН (NISSENS) 641 488 32



W210 E 280	2799M112	G	A	*/-	7/95-
W210 E 280 4 MATIC	2799M112	G	A	*/-	7/95-
W210 E 320	3199M104	G	A	*/-	7/95-

MD21095-911 2105000003 62667A W210 '95- РАДИАТОР ОХЛАЖДЕН (NISSENS) 641 488 32





W210 E 280	2799M112	G	M	*/-	95/7-97/5
W210 E 280 4 MATIC	2799M112	G	M	*/-	95/7-
W210 E 280 4 MATIC	2799M112	G	M	*/-	95/7-97/5
W210 E 320	3199M104	G	M	*/-	95/7



MD21095-912 2105001203 62689A W210 '95- РАДИАТОР ОХЛАЖДЕН (NISSENS) 640 490 40

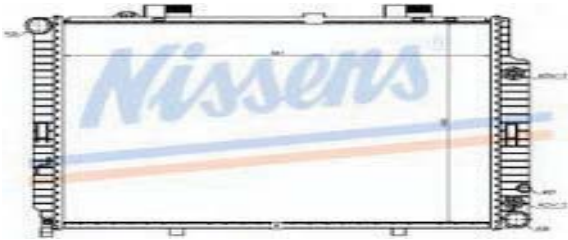
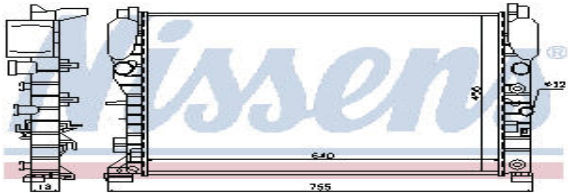
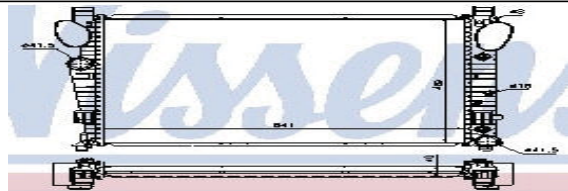
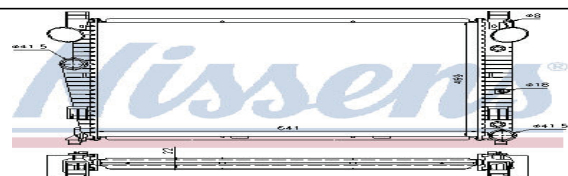

W210 E 300D	2996OM606	D	A	*	7/95-
W210 E 420	4196M119	G	A	*	1/96-
W210 E 420 T-MODEL	4196M119	G	A	*	1/96-
W210 E 430	4266M113	G	A	*/-	4/97-
W210 E 430 T-MODEL	4266M113	G	A	*/-	4/97-
W210 E 50 AMG	4973M119	G	A	*	1/96-

№ФОРВАРДА	№ OEM	№ NISSENS	МОДЕЛЬ	ТИП ДВИГАТЕЛЯ	БЕН/Д ИЗ	ТИП КП	КОНД ИЦИ	ГОД	ПРИМЕЧА НИЕ
MD21095-913	21050003/2803	62691A	W210 '95- РАДИАТОР ОХЛАЖДЕН (NISSENS)						640 489 32
			W210 E 200	1998M111	G	MA	*	7/95-	
			W210 E 200 T-MODEL	1998M111	G	MA	*	7/95-	
			W210 E 220D	2155OM604	D	MA	*	7/95-	
			W210 E 230	2295M111	G	MA	*	7/95-	
			W210 E 230 T-MODEL	2295M111	G	MA	*	7/95-	
									
MD21095-914	2105000103	62692A	W210 '95- РАДИАТОР ОХЛАЖДЕН (NISSENS)						640 490 40
			W210 E 300D	2996OM606	D	M	*	7/95-	
									
MD21097-910	2105006303	62611A	W210 '97-99 РАДИАТОР ОХЛАЖДЕН (NISSENS)						641 488 0
			W210 E 250TD	2497OM605	D	M	*/-	6/97-7/99	
			W210 E 250TD T-MODEL	2497OM605.962	D	M	*/-	6/97-	
									
MD21097-911	2105006003	62609	W210 '97- РАДИАТОР ОХЛАЖДЕН (NISSENS)						641 496 0
			W210 E 200 КОМПРЕССОР		G	MA	*/-	9/97-	
			W210 E200 KOMPR.T-MODEL		G	MA	*/-	9/97-	
									
MD21098-910	2105006103	62607	W210 '98- РАДИАТОР ОХЛАЖДЕН (NISSENS)						641 496 0
			W210 E 200D	OM611	D	M	*/-	1/98-	
			W210 E 220 CDI	2151	D	M	*/-	7/99-	
			W210 E 220 CDI T-MODEL	2151 611961	D	M	*/-	6/98-7/99	
			W210 E 220 CDI T-MODEL	2151	D	M	*/-	7/99-	
			W210 E 220CDI	2151 611961	D	M	*/-	6/98-7/99	
			W210 E 220TD	OM611	D	M	*/-	1/98-	
									

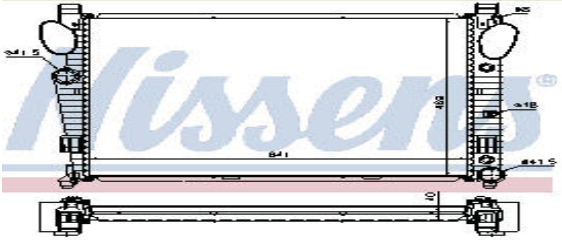
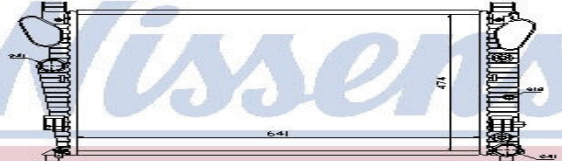

№ ФОРВАРДА	№ OEM	№ NISSENS	МОДЕЛЬ	ТИП ДВИГАТЕЛЯ	БЕН/Д ИЗ	ТИП КП	КОНД ИЦИ	ГОД	ПРИМЕЧА НИЕ
MD21098-911	2105006203	62608A	W210 '98- РАДИАТОР ОХЛАЖДЕН (NISSENS)						641 496 0
			W210 E 200D	OM611	D	A	*/-	1/98-	
			W210 E 220 CDI	2151	D	A	*/-	7/99-	
			W210 E 220 CDI T-MODEL	2151 611961	D	A	*/-	6/98-7/99	
			W210 E 220 CDI T-MODEL	2151	D	A	*/-	7/99-	
			W210 E 220CDI	2151 611961	D	A	*/-	6/98-7/99	
			W210 E 220TD	OM611	D	A	*/-	1/98-	
MD21102-910	2115000102	62793	W211 02- РАДИАТОР ОХЛАЖДЕН (NISSENS)						640 456 18
			E-CLASS W 211 200	M271.946	G	M/A	+/-	09/02 -	
			E-CLASS W 211 240	M 112.913	G	M/A	+/-	09/02 -	
			E-CLASS W 211 240 4-MATIC	M 112.917	G	A	+/-	09/02 -	
			E-CLASS W 211 320	M 112.949	G	M/A	+/-	09/02 -	
			E-CLASS W 211 320 4-MATIC	M 112.954	G	A	+/-	09/02 -	
			E-CLASS W 211 350	M 272.964	G	M/A	+/-	09/02 -	
E-CLASS W 211 350 4-MATIC	M 272.972	G	M/A	+/-	09/02 -				
MD22000-910	220500203	62547A	W220 00-/+ W215 00-} РАДИАТОР ОХЛАЖДЕН (NISSENS)						641 469 40
MD22000-911	220500203	62547	W220 00-/+ W215 00-} РАДИАТОР ОХЛАЖДЕН						641 469 48
			CL-CLASS W 215 55 AMG KOMPR.	M113.991	G	A	+	09/03 -	
			CL-CLASS W 215 600	M113.960	G	A	+	03/99 -	
			CL-CLASS W 215 65 AMG	M275.980	G	A	+	09/03 -	
			S-CLASS W 220 320 CDI	OM613.960	D	A	+/-	01/00 -	
			S-CLASS W 220 400 CDI	OM628.960	D	A	+/-	06/00 -	
			S-CLASS W 220 55 AMG KOMPR.	M 113.991	G	A	+/-	06/02 -	
			S-CLASS W 220 600	M137.970	G	A	+/-	01/00 -	
			S-CLASS W 220 65 AMG	M 275.980	G	A	+/-	03/04 -	
			SL-CLASS W 230 665 AMG	M 275.981	G	M/A	+	10/01 -	
MD22098-910	2205000003	62771A	W220 98-99 РАДИАТОР ОХЛАЖДЕН (NISSENS)						641 469 22
			S-CLASS W 220 280	M112.922	G	A	+/-	09/97 - 04/99	
			S-CLASS W 220 320	M112.944	G	A	+/-	06/97 - 04/99	

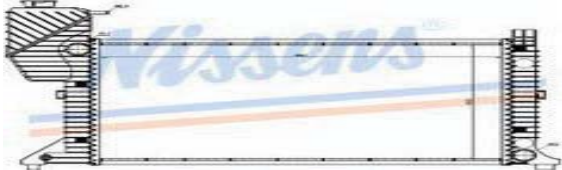
№ФОРВАРДА	№ OEM	№ NISSENS	МОДЕЛЬ	ТИП ДВИГАТЕЛЯ	БЕН/Д ИЗ	ТИП КП	КОНД ИЦИ	ГОД	ПРИМЕЧА НИЕ
MD22098-911	2205000903	62773A	W220 98-99 {+ W215 00-} РАДИАТОР ОХЛАЖДЕН (NISSENS)						641 469 40
			CL-CLASS W 215 500 CL-CLASS W 215 55 AMG S-CLASS W 220 430 S-CLASS W 220 430 4-MATIC S-CLASS W 220 500 S-CLASS W 220 500 4-MATIC S-CLASS W 220 55 AMG	M113.960 M113.960 M113.941 M113.948 M113.960 M113.966 M 113.986	G G G G G G G	A A A A A A A	+ + +/- +/- +/- +/- +/-	03/99 - 10/99 - 04/99 - 04/99 - 04/99 - 04/99 - 04/99 -	
MD22098-912	2205001403/2403	62774A	W220 98-99 РАДИАТОР ОХЛАЖДЕН (NISSENS)						641 469 26
			S-CLASS W 220 280 S-CLASS W 220 320 S-CLASS W 220 350 S-CLASS W 220 350 4-MATIC	M112.922 M112.944 M112.972 M112.975	G G G G	A A A A	+/- +/- +/- +/-	04/99 - 04/99 - 04/99 - 04/99 -	
MDSPR94-910	9015003400	62686	SPRINTER '94- РАДИАТОР ОХЛАЖДЕН (NISSENS)						680 408 40
			SPRINTER 208D SPRINTER 212D SPRINTER 214 SPRINTER 308D SPRINTER 312D SPRINTER 314 SPRINTER 408D SPRINTER 412D SPRINTER 414	OM601 OM602 M111 OM601 OM602 M111 OM601 OM602 M111	D D G D D G D D G	A A A A A A A A	*/- */- */- */- */- */- */- */- */-	1/94- 1/94- 1/94- 1/94- 1/94- 1/94- 1/94- 1/94- 1/94-	
MDSPR94-911	9015001800	62687	SPRINTER '94- РАДИАТОР ОХЛАЖДЕН (NISSENS)						570 400 30
			SPRINTER 208D SPRINTER 214 SPRINTER 308D SPRINTER 314 SPRINTER 408D SPRINTER 414	OM601 M111 OM601 M111 OM601 M111	D G D G D G	M M M M M M	— — — — — —	1/94- 1/94- 1/94- 1/94- 1/94- 1/94-	

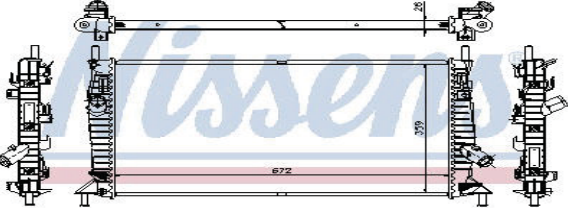
№ ФОРВАРДА	№ OEM	№ NISSENS	МОДЕЛЬ	ТИП ДВИГАТЕЛЯ	БЕН/Д ИЗ	ТИП КП	КОНД ИЦИ	ГОД	ПРИМЕЧА НИЕ
MDSPR97-910	9015003100	62664A	SPRINTER '97- РАДИАТОР ОХЛАЖДЕН (NISSENS)						680 409 32
			SPRINTER 208D	OM601	D	M	—	95/1-00/4	
			SPRINTER 210D	OM601	D	M	—	95/2-00/4	
			SPRINTER 212D	OM601	D	M	—	95/2-00/4	
			SPRINTER 310D	OM602	D	M	—	95/2-00/4	
			SPRINTER 312D	OM602	D	M	—	95/2-00/4	
			SPRINTER 408D	OM601	D	M	—	96/2-	
			SPRINTER 410D	OM602,980	D	M	—	96/2-	
			SPRINTER 412D	OM602,980	D	M	—	95/2-	

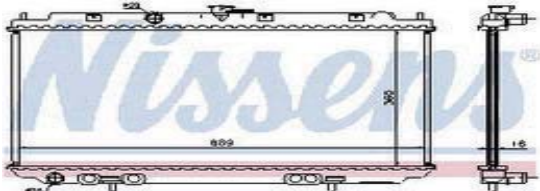
№ ФОРВАРДА	№ OEM	№ NISSENS	МОДЕЛЬ	ТИП ДВИГАТЕЛЯ	БЕН/Д ИЗ	ТИП КП	КОНД ИЦИ	ГОД	ПРИМЕЧА НИЕ
MZX0304-911	1251092/1300467/8603244/Y60115200B/C	62017A	3 04- {+ FD FOCUS 05- / C-MAX 03- / VV S40 04-} РАДИАТОР ОХЛАЖДЕН 1.3 1.6 2 (NISSENS)						672 359 26
			FOCUS 1.4 i 16V		G	M	+	07/04 -	
			FOCUS 1.6 i 16V		G	M/A	+	07/04 -	
			FOCUS 1.8 i 16V		G	M/A	+/-	07/04 -	
			FOCUS 2.0 i 16V		G	M/A	+/-	07/04 -	
			FOCUS 1.6 TDCi		D	M/A	+/-	07/04 -	
			FOCUS 1.8 TDCi		D	M/A	+/-	07/04 -	
			FOCUS 2.0 TDCi		D	M/A	+/-	07/04 -	
			FOCUS C-MAX 1.6 i 16V		G	M/A	+	10/03 -	
			FOCUS C-MAX 1.8 i 16V		G	M/A	+/-	10/03 -	
			FOCUS C-MAX 2.0 i 16V		G	M/A	+/-	10/03 -	
			FOCUS C-MAX 1.6 TDCi		D	M/A	+/-	10/03 -	
			FOCUS C-MAX 1.8 TDCi		D	M/A	+/-	10/03 -	
			FOCUS C-MAX 2.0 TDCi		D	M/A	+/-	10/03 -	
			3 1.4 i 16V	ZJVE	G	M	+/-	02/04 -	
			3 1.6 CDVi	MZ-CD	D	M	+/-	06/04 -	
			3 1.6 i 16V	ZYVE	G	M	+/-	10/03 -	
			3 2.0 CDVi	MZ-CD	D	M	+/-	06/04 -	
			3 2.0 i 16V	LFD	G	M	+/-	10/03 -	
			5 1.6 CDVi	MZ-CD	D	M	+/-	06/04 -	
			5 1.8 i 16V	L8D	G	M/A	+/-	10/03 -	
			5 2.0 CDVi	MZ-CD	D	M	+/-	06/04 -	
5 2.0 i 16V	LFD	G	M/A	+/-	10/03 -				
C 30 1.6 D		D	M	+/-	01/04 -				
C 30 2.0 D	D4204T2	D	M	+/-	01/04 -				
S40 / V50 1.6 D		D	M	+/-	01/04 -				
S40 / V50 2.0 D	D4204T/D4204T2	D	M	+/-	01/04 -				

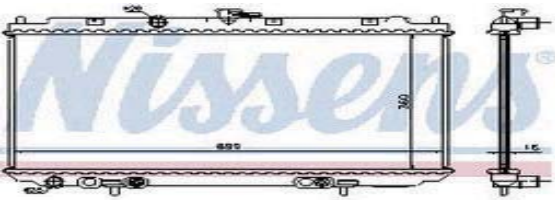
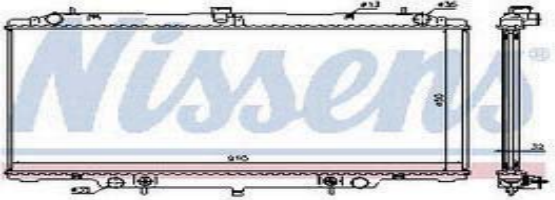
№ ФОРВАРДА	№ OEM	№ NISSENS	МОДЕЛЬ	ТИП ДВИГАТЕЛЯ	БЕН/Д ИЗ	ТИП КП	КОНД ИЦИ	ГОД	ПРИМЕЧА НИЕ
NNALM02-910	21410BM400/21410BM402	67344A	ALMERA '02- {+ P12 02-} РАДИАТОР ОХЛАЖДЕНИЯ (NISSENS)						360 689 16
			ALMERA N16 1,5i 16V	QG15DE	G	M	*	00/3-	
			ALMERA N16 1,8i 16V	QG18DE	G	M	*	00/3-	
			PRIMERA P 12 1,6i 16V	QG15DE	G	M	*/-	02/3-	
			PRIMERA P 12 1,8i 16V	QG18DE	G	M	*/-	02/3-	

№ФОРВАРДА	№ OEM	№ NISSENS	МОДЕЛЬ	ТИП ДВИГАТЕЛЯ	БЕН/Д ИЗ	ТИП КП	КОНД ИЦИ	ГОД	ПРИМЕЧА НИЕ
NNALM02-911	21460BM700/21460BM7022/1460AV700	67345A	ALMERA '02- (+ P12 02-) РАДИАТОР ОХЛАЖДЕНИЯ (NISSENS)						360 689 16
			ALMERA N16 1,8i 16V	QG18DE	G	A	*	00/03-	
			PRIMERA P12 1,6i 16V	QG16DE	G	A	*/-	02/03-	
			PRIMERA P12 1,8i 16V	QG18DE	G	A	*/-	02/03-	
									
NNPTG98-910	21460VB300	62953A	PATROL GR '98-РАДИАТОР ОХЛАЖДЕНИЯ (NISSENS)						450 910 32
			PATROL Y61 2,8 TD	RD28TI	D	A	*/-	97/10-	
			PATROL Y61 2,8 TD	RD28TI	D	A	*	97/10-	
			PATROL Y61 3,0 TD	ZD30DDTI	D	M	*	97/10-	
			PATROL Y61 3,0 TD	ZD30DDTI	D	A	*	97/10-	
									
OPAST91-910	1300134/108/90443465	63059A	ASTRA '91-97 РАДИАТОР ОХЛАЖДЕН (NISSENS)						536 368 32
OPAST91-917	1300134	63059A	ASTRA '91-97 РАДИАТОР ОХЛАЖДЕН (DELPHI)						536 368 32
			ASTRA C 1,6 16V	1598 16LZ2/X16XEL	G	M		9/91-	
			ASTRA C 1,7D	1699 17D	D	M		9/91-	
			ASTRA C 1,8 16V	1796C18XE	G	M		9/91-	
			ASTRA C 1,8i	1796C18NZ	G	M		9/91-	
			ASTRA C 2,0 16V	1998C20XE	G	M		9/91-	
			ASTRA C 2,0i	1998C20NE	G	M		9/91-	
			ASTRA F 1,6 16V	1598 16LZ2/X16XEL	G	M		9/91-12/97	
			ASTRA F 1,7D	17D	D	M		9/91-8/94	
			ASTRA F 1,8i	C18NZ	G	M		9/91-2/98	
			ASTRA F 1,8i 16V	C18XE	G	M		9/91-12/97	
			ASTRA F 2,0i	C20NE	G	M		9/91-2/98	
			ASTRA F 2,0i/16V	C20XE	G	M		9/91-2/98	
									
OPAST91-911	1300147/116	63252A	ASTRA '91-97 РАДИАТОР ОХЛАЖДЕН (NISSENS)						585 348 32
OPAST91-919	1300147/116	63252A	ASTRA '91-97 РАДИАТОР ОХЛАЖДЕН						585 348 32
			ASTRA F 1,4i	C14SE/C14NZ	G	M	*	9/91-2/92	
			ASTRA F 1,6i	C16SE/C16NZ	G	M	*	9/91-2/92	
			ASTRA F 1,6i	C16SE/NZ/SZ	G	M	*	2/92-12/97	
			ASTRA F 1,6i 16V	X16XE	G	M	*	9/91-12/97	
			ASTRA F 1,8i	C18NZ	G	M	*	9/91-12/97	
			ASTRA F 1,8i 16V	C18XE	G	M	*	9/91-12/97	
			ASTRA F 2,0i	C20NE	G	M	*	9/91-12/92	
			ASTRA F 2,0i/16V	C20XE	G	M	*	9/91-12/97	
									

№ ФОРВАРДА	№ OEM	№ NISSENS	МОДЕЛЬ	ТИП ДВИГАТЕЛЯ	БЕН/Д ИЗ	ТИП КП	КОНД ИЦИ	ГОД	ПРИМЕЧА НИЕ
	1300148/109	63253A	ASTRA '91-97 РАДИАТОР ОХЛАЖДЕН (NISSENS)						590 365 32
			ASTRA F 1,4i	C14SE/C14NZ	G	A	*	2/92-12/97	
			ASTRA F 1,4i	C14SE/C14NZ	G	A	*	9/91-2/92	
			ASTRA F 1,6i	C16SE/C16NZ	G	A	*	9/91-2/92	
			ASTRA F 1,6i	C16SE/NZ/SZ	G	A	*	2/92-12/97	
			ASTRA F 1,8i	C18NZ	G	A	*	9/91-12/97	
OPAST91-913	1300140/113/154/112/90325151/469375	63276A	ASTRA '91-97 РАДИАТОР ОХЛАЖДЕН (NISSENS)					525 328 22	
OPAST91-916	1300112/90412252	63276A	ASTRA '91-97 РАДИАТОР ОХЛАЖДЕН (DELPHI)					525 328 22	
OPAST91-918	1300140/113/154/112/90325151/469375	63276A	ASTRA '91-97 РАДИАТОР ОХЛАЖДЕН					525 328 22	
			ASTRA C 1,4 16V	1389C14XE	G	M		09/91-	
			ASTRA C 1,4i	1389 14NV/C14NZ/SE	G	M		09/91-	
			ASTRA C 1,6i	1598C16NZ/SE	G	M		09/91-	
			ASTRA F 1,4i	14NV/C14NZ/SE-OHC	G	M		09/91-02/98	L.PIN
			ASTRA F 1,6i	C16NZ/SE	G	M		09/91-02/98	L.PIN
OPAST91-914	1300115/90412253	632831	ASTRA '91-97 РАДИАТОР ОХЛАЖДЕН (NISSENS)					525 328 23	
OPAST91-916	1300115/90412253	63283	ASTRA '91-97 РАДИАТОР ОХЛАЖДЕН					525 328 23	
			ASTRA C 1,6i	1598C16NZ/SE	G	A		91/9-97/12	
			ASTRA F1,4i	1389C14NZ	G	A		91/9-	
			ASTRA F1,4i	1389C14SE	G	A		91/9-	
			ASTRA F1,4i	1389X14NZ	G	A		91/9-	
			ASTRA F1,6i	1598C16NZ	G	A		91/9-	
			ASTRA F1,6i	1598C16SE	G	A		91/9-	
			ASTRA F1,6i	1598X16SZ	G	A		91/9-	
			ASTRA F1,6i	1598X16SZR	G	A		91/9-	
OPAST91-915	1300114	63293	ASTRA '91-97 РАДИАТОР ОХЛАЖДЕН (NISSENS)					524 298 24	
			ASTRA C 1,6i	C16NZ/SE	G	M		91/9-92/2	
			ASTRA F 1,4i	C14NV	G	M		9/91-2/98	S.PIN
			ASTRA F 1,6i	C16NZ	G	M		9/91-2/98	S.PIN

№ФОРВАРДА	№ OEM	№ NISSENS	МОДЕЛЬ	ТИП ДВИГАТЕЛЯ	БЕН/Д ИЗ	ТИП КП	КОНД ИЦИ	ГОД	ПРИМЕЧА НИЕ
OPAST98-910	90570728/93277988/1300214	630041	ASTRA '98- (+ZAFIRA) РАДИАТОР ОХЛАЖДЕНИЯ (NISSENS)						600 377 34
OPAST98-916	90570728/93277988/1300214	63004	ASTRA '98- (+ZAFIRA) РАДИАТОР ОХЛАЖДЕН						600 377 34
OPAST98-918	09119482/9193265/1300196/1300257	63004	ASTRA '98- (+ZAFIRA) РАДИАТОР ОХЛАЖДЕН						600 377 34
			VIVA (05-) 1,8 I 16V		G	M	+	01/05 - 00/00	
			ASTRA G 1,4 I 16V	1389X14XE	G	M	*	12/97-	
			ASTRA G 1,6 I 16V	1598X16SZR	G	M	*	12/97-	
			ASTRA G 1,6 I 16V	1598X16XEL	G	M	*	12/97-	
			ASTRA G 1,6 I 16V	1598Z16XE	G	M	*	12/97-	
			ASTRA G 1,8 I 16V	1796X18XE	G	M	*	12/97-	
			ASTRA G 2,2 I 16V	2198Z22SE	G	M	*	2/00-	
			ASTRA B 1,4 I 16V	1389X14XE	G	M	*	4/98-	
			ASTRA B 1,6 I 16V	1598X16XEL	G	M	*	4/98-	
			ASTRA B 1,8 I 16V	1799X18XE1	G	M	*	4/98-	
			ZAFIRA 1,6 I 16V	1598X16XEL	G	M	*	12/97-	
			ZAFIRA 1,6 I 16V	1598Z16XE	G	M	*	12/97-	
			ZAFIRA 1,8 I 16V	1796X18XE	G	M	*	12/97-	
			ZAFIRA 2,2 I 16V	2198Z22SE	G	M	*	2/00-	
OPAST98-911	90570725/1300186/9202496	63005A	ASTRA '98- (+ZAFIRA) РАДИАТОР ОХЛАЖДЕНИЯ(NISSENS)						540 375 22
			ASTRA D 1,4 I 16V	1389X14XE	G	M	*	4/98-	
			ASTRA D 1,6 I 16V	1598X16XEL	G	M	*	4/98-	
			ASTRA D 1,8 I 16V	1799X18XE1	G	M	*	4/98-	
			ASTRA G 1,4 I 16V	1389X14XE	G	M	*	12/97-	
			ASTRA G 1,6 I 16V	1598X16SZR	G	M	*	12/97-	
			ASTRA G 1,6 I 16V	1598X16XEL	G	M	*	12/97-	
			ASTRA G 1,6 I 16V	1598Z16XE	G	M	*	12/97-	
			ASTRA G 1,8 I 16V	1796X18XE	G	M	*	12/97-	
			ZAFIRA 1,6 I 16V	1598X16XEL	G	M	*	12/97-	
			ZAFIRA 1,6 I 16V	1598Z16XE	G	M	*	12/97-	
			ZAFIRA 1,8 I 16V	1796X18XE	G	M	*	12/97-	
OPAST98-912	1300208	63006A	ASTRA '98- (+ZAFIRA) РАДИАТОР ОХЛАЖДЕНИЯ(NISSENS)						600 369 32
			ASTRA G 2,0 I 16V	1998X20XE1	G	M	*	12/97-	
			ASTRA G 2,0 I 16V	1998X20XE1	G	M	*	12/97-	
			ASTRA G 2,0 TD	1998X20DTL	D	M	*	12/97-	
			ASTRA G 2,0 TD	1998X20DTL	D	M	*	12/97-	
			ASTRA G 2,0 TD	1998Y20DTL	D	M	*	12/97-	
			ASTRA G 2,0 TD	1998Y20DTL	D	M	*	12/97-	
			ASTRA G 2,2 TD	2172Y22DTR	D	M	*	2/00-	
			ZAFIRA 2,0 I 16V	1998X20XE1	G	M	*	12/97-	
			ZAFIRA 2,0 I 16V	1998X20XE1	G	M	*	12/97-	
			ZAFIRA 2,0 TD	1998X20DTL	D	M	*	12/97-	
			ZAFIRA 2,0 TD	1998X20DTL	D	M	*	12/97-	
			ZAFIRA 2,0 TD	1998Y20DTL	D	M	*	12/97-	
			ZAFIRA 2,0 TD	1998Y20DTL	D	M	*	12/97-	
			ZAFIRA 2,2 TD	2172Y22DTR	D	M	*	2/00-	
OPAST98-913	09119482/9193265/1300196/1300257	632461	ASTRA '98- (+ZAFIRA) РАДИАТОР ОХЛАЖДЕНИЯ(NISSENS)						600 375 22
			ASTRA D 1,4 I 16V	1389X14XE	G	A	*	4/98-	
			ASTRA D 1,6 I 16V	1598X16XEL	G	A	*	4/98-	
			ASTRA D 1,8 I 16V	1799X18XE1	G	A	*	4/98-	
			ASTRA G 1,4 I 16V	1389X14XE	G	A	*	12/97-	
			ASTRA G 1,6 I 16V	1598X16SZR	G	A	*	12/97-	
			ASTRA G 1,6 I 16V	1598X16XEL	G	A	*	12/97-	
			ASTRA G 1,6 I 16V	1598Z16XE	G	A	*	12/97-	
			ASTRA G 1,8 I 16V	1796X18XE	G	A	*	12/97-	
			ASTRA G 2,2 I 16V	2198Z22SE	G	A	*	2/00-	
			ZAFIRA 1,6 I 16V	1598X16XEL	G	A	*	12/97-	
			ZAFIRA 1,6 I 16V	1598Z16XE	G	A	*	12/97-	
			ZAFIRA 1,8 I 16V	1796X18XE	G	A	*	12/97-	
			ZAFIRA 2,2 I 16V	2198Z22SE	G	A	*	2/00-	

№ФОРВАРДА	№ OEM	№ NISSENS	МОДЕЛЬ	ТИП ДВИГАТЕЛЯ	БЕН/Д ИЗ	ТИП КП	КОНД ИЦИ	ГОД	ПРИМЕЧА НИЕ
OPAST98-914	09119483/1300197/216/241/90570731	63247A	ASTRA '98- (+ZAFIRA) РАДИАТОР ОХЛАЖДЕНИЯ(NISSENS)						600 369 32
OPAST98-917	09119483/1300197/216/241/90570731	63247	ASTRA '98- (+ZAFIRA) РАДИАТОР ОХЛАЖДЕН						600 369 32
			ASTRA D 2,0 DI 16V	1799X18XE1	D	M	*	4/98-	
			ASTRA D 2,0 I 16V	1799X18XE1	G	A	*	4/98-	
			ASTRA G 2,0 I 16V	1998X20XE1	G	A	*	12/97-	
			ASTRA G 2,0 I 16V	1998X20XE1	G	A	*	12/97-	
			ASTRA G 2,0 I 16V TURBO	1998Z20LET	G	M	*	12/97-	
			ASTRA G 2,0 I 16V TURBO	1998Z20LET	G	M	*	12/97-	
			ASTRA G 2,0 TD	1998X20DTL	D	A	*	12/97-	
			ASTRA G 2,0 TD	1998X20DTL	D	A	*	12/97-	
			ASTRA G 2,0 TD	1998X20DTL	D	A	*	12/97-	
			ASTRA G 2,0 TD	1998X20DTL	D	A	*	12/97-	
			ASTRA G 2,2 I 16V	2198Z22SE	G	M	*	2/00-	
			ASTRA G 2,2 I 16V	2198Z22SE	G	A	*	2/00-	
			ZAFIRA 1,8 DI	1796	G		*	0/99-	
			ZAFIRA 2,0 DI 16V	199820DTL	D	M	*	0/99-	
			ZAFIRA 2,0 I 16V	1998X20XE1	G	A	*	12/97-	
			ZAFIRA 2,0 I 16V	1998X20XE1	G	A	*	12/97-	
			ZAFIRA 2,0 I 16V TURBO	1998Z20LET	G	M	*	12/97-	
			ZAFIRA 2,0 I 16V TURBO	1998Z20LET	G	M	*	12/97-	
			ZAFIRA 2,0 TD	1998Y20DTL	D	A	*	12/97-	
			ZAFIRA 2,0 TD	1998Y20DTL	D	A	*	12/97-	
			ZAFIRA 2,0 TD	1998Y20DTL	D	A	*	12/97-	
			ZAFIRA 2,0 TD	1998Y20DTL	D	A	*	12/97-	
			ZAFIRA 2,2 I 16V	2198Z22SE	G	M	*	2/00-	
			ZAFIRA 2,2 I 16V	2198Z22SE	G	A	*	2/00-	
OPAST98-915	90570726/1300187/9202493/1300213	63248A	ASTRA '98- (+ZAFIRA) РАДИАТОР ОХЛАЖДЕНИЯ(NISSENS)						537 359 22
			ASTRA D 1,4 I 16V	1389X14XE	G	A		4/98-	
			ASTRA D 1,6 I 16V	1598X16XEL	G	A		4/98-	
			ASTRA D 1,8 I 16V	1799X18XE1	G	A		4/98-	
			ASTRA G 1,4 I 16V	1389X14XE	G	A		12/97-	
			ASTRA G 1,6 I 16V	1598X16SZR	G	A		12/97-	
			ASTRA G 1,6 I 16V	1598X16XEL	G	A		12/97-	
			ASTRA G 1,6 I 16V	1598Z16XE	G	A		12/97-	
			ASTRA G 1,8 I 16V	1796X18XE	G	A		12/97-	
			ZAFIRA 1,6 I 16V	1598X16XEL	G	A		12/97-	
			ZAFIRA 1,6 I 16V	1598Z16XE	G	A		12/97-	
			ZAFIRA 1,6 I 16V	1796X18	G	M		0/99-	
			ZAFIRA 1,8 I 16V	1796X18XE	G	A		12/97-	
OPAST04-910	1300265/13145210	63027A	ASTRA 04- РАДИАТОР ОХЛАЖДЕН (NISSENS)						602 369 16
			ASTRA H 1.2 i 16V	Z12XEP	G	M/A	+/-	03/04 -	
			ASTRA H 1.4 i 16V	Z14XEL/Z14XEP	G	M/A	+/-	03/04 -	
			ASTRA H 1.8 i 16V	Z18XE/Z18XE	G	M/A	+/-	03/04 -	
			ZAFIRA B 1.6 GAS	Z16YNG	G	M	+/-	09/05 -	
			ASTRA H 1.2 i 16V	Z12XEP	G	M/A	+/-	03/04 -	
			ASTRA H 1.4 i 16V	Z14XEL/Z14XEP	G	M/A	+/-	03/04 -	
			ASTRA H 1.8 i 16V	Z18XE/Z18XE	G	M/A	+/-	03/04 -	
			ZAFIRA B 1.6 GAS	Z16YNG	G	M	+/-	09/05 -	
OPAST04-911	1300266	63028A	ASTRA 04- (+ ZAFIRA B 05-) РАДИАТОР ОХЛАЖДЕН (NISSENS)						602 369 16
			ASTRA H 1.6 I 16V	Z16XEP	G	M	+/-	03/04 -	
			ASTRA H 1.8 I 16V	Z18XER	G	M	+/-	03/04 -	
			ZAFIRA B 1.6 I 16V	Z16XEP	G	M	+/-	09/05 -	
			ZAFIRA B 1.8 I 16V	Z18XER	G	M	+/-	09/05 -	
			ASTRA H 1.6 I 16V	Z16XEP	G	M	+/-	03/04 -	
			ASTRA H 1.8 I 16V	Z18XER	G	M	+/-	03/04 -	
			ZAFIRA B 1.6 I 16V	Z16XEP	G	M	+/-	09/05 -	
			ZAFIRA B 1.8 I 16V	Z18XER	G	M	+/-	09/05 -	



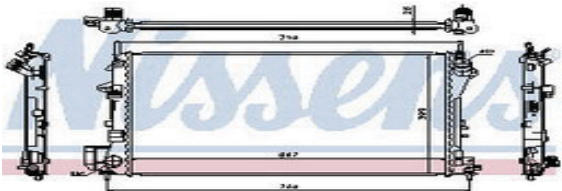
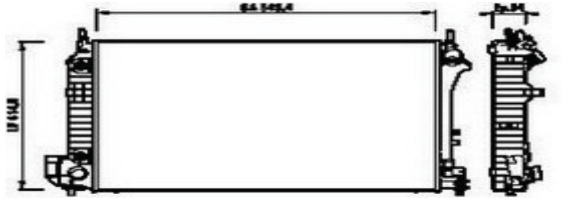
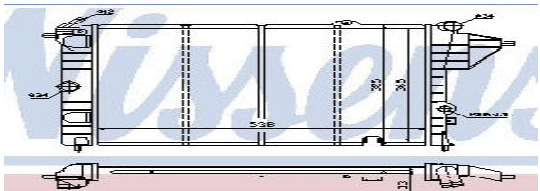
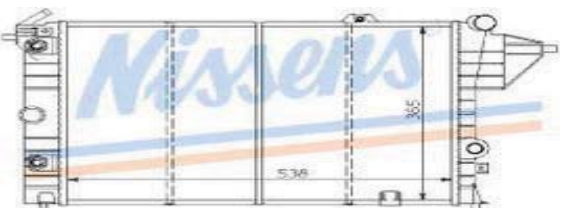

№ФОРВАРДА	№ OEM	№ NISSENS	МОДЕЛЬ	ТИП ДВИГАТЕЛЯ	БЕН/Д ИЗ	ТИП КП	КОНД ИЦИ	ГОД	ПРИМЕЧА НИЕ
OPFRT91-910	1300119/1300120/1302058/91146915/91147724	63244	FRONTERA '91-94 РАДИАТОР ОХЛАЖДЕН (NISSENS)						424 601 33
			FRONTERA 2,0i	1998 C20NE	G	M	*/-	3/91-3/95	
			FRONTERA 2,0i	1999 X20SE	G	M	*/-	10/94-8/98	
			FRONTERA 2,2i	2200 X20SE	G	M	*/-	10/94-8/98	
			FRONTERA 2,2i 16V	2200 X20SE	G	M	*/-	10/94-8/98	
			FRONTERA 2,4i	2410C24NE	G	M	*/-	2/92-9/94	
OPFRT91-911	1300121/91146914	63245	FRONTERA '91-94 РАДИАТОР ОХЛАЖДЕН (NISSENS)						424 603 42
			FRONTERA 2,3 TURBO D	226023DTR	D	M	*/-	3/91-	
			FRONTERA 2,3TD	226023DTR	D	M		3/91-9/94	
OPKAD84-910	1302026/074/90444154	63238A	КАДЕТТ '84-89 РАДИАТОР ОХЛАЖДЕН (NISSENS)						528 268 22
OPKAD84-912	1302026/074/90444154	63238A	КАДЕТТ '84-89 РАДИАТОР ОХЛАЖДЕН						528 268 22
			ASTRA B 1,3N/S	1297	G	M		9/84-3/89	
			BELMONT 1,2S	1197	G	M		9/85-8/91	
			BELMONT 1,3N/S	1297	G	M		9/85-3/89	
			KADETTE 1,2S	1196S/ST	G	M		8/84-8/85	
			KADETTE 1,3N/S	13N/S/NB-C13N	G	M		8/84-3/89	
OPKAD84-911	1302029/27	63274	КАДЕТТ '84-91 РАДИАТОР ОХЛАЖДЕН (NISSENS)						630 303 33
			ASTRA B 1,6N/S/I	1598	G	M		9/84-3/89	
			ASTRA B 1,8S/I/GSI	1796	G	M		9/84-8/91	
			BELMONT 1,6N/S/I	1598	G	M		9/85-3/89	
			BELMONT 1,8S/I	1796	G	M		9/85-8/91	
			KADETTE 1,6N/S/I	16SV/C16LZ/NZ	G	M		9/84-3/89	
			KADETTE 1,8S/I/GSI	18NV/E-C18E/NT-C18NZ	G	M		8/84-10/91	

№ ФОРВАРДА	№ OEM	№ NISSENS	МОДЕЛЬ	ТИП ДВИГАТЕЛЯ	БЕН/Д ИЗ	ТИП КП	КОНД ИЦИ	ГОД	ПРИМЕЧА НИЕ
ОРОМВ86-913	90231318/1300010	63040	ОМЕГА '86-93 РАДИАТОР ОХЛАЖДЕН (NISSENS)						400 495 21
			CARLTON B 1,8N/S/I CARLTON B 2,0I OMEGA A 1,8I OMEGA A 1,8N/S OMEGA A 2,0N/I	179618NV/SV/E18NVR 1998C20NE/20SE 18SEH 18NV/NVR 20NV/SE-20NE/SE	G G G G G	M MA M M M		10/86-2/94 10/86-2/94 10/86-5/94 10/86-5/94 10/86-5/94	WFN WFN WFN
ОРОМВ86-914	90280691/231321/1300009	63043	ОМЕГА '86-93 РАДИАТОР ОХЛАЖДЕН (NISSENS)						400 495 21
			OMEGA A 1,8I OMEGA A 1,8N/S OMEGA A 2,0N/I	18SEH 18NV/NVR 20NV/SE-20NE/SE	G G G	M M M		10/86-5/94 10/86-5/94 10/86-5/94	
ОРОМВ86-915	1300095	63049	ОМЕГА '86-93 РАДИАТОР ОХЛАЖДЕН (NISSENS)						545 460 42
			CARLTON B 2,6I CARLTON B 3,0I/24V OMEGA A 2,6I OMEGA A 3,0I	2594C26NE 296930NE/C30NE/LE/S C26NE 30NE-C30SE/LE	G G G G	M M M M	** * *	10/86-2/94 10/86-2/94 10/86-2/94 10/86-2/94	
ОРОМВ94-910	6302007	63072A	ОМЕГА '94-99 РАДИАТОР ОХЛАЖДЕН (NISSENS)						653 460 27
			OMEGA B 2,0I OMEGA B 2,0I/16V OMEGA B 2,5I/24V OMEGA B 3,0I/24V	20SE/X20SE X20XE X25XE X30XE	G G G G	MA MA MA MA	** 	3/94- 3/94- 3/94- 3/94-	

№ ФОРВАРДА	№ OEM	№ NISSENS	МОДЕЛЬ	ТИП ДВИГАТЕЛЯ	БЕН/Д ИЗ	ТИП КП	КОНДИ ЦИ	ГОД	ПРИМЕЧА НИЕ
ОРОМВ94-911	6302006	63073A	ОМЕГА '94-99 РАДИАТОР ОХЛАЖДЕН (NISSENS)						653 460 27
			ОМЕГА 2,5i V6			G	MA	*	94/4-
			ОМЕГА B 2,5i/24V	X25XE		G	MA	*	3/94-
			ОМЕГА B 2,6 V6 24V	Y26SE		G	MA	*	00/9-
			ОМЕГА B 3,0i V6			G	MA	*	94/4-
			ОМЕГА B 3,0i/24V	X30XE		G	MA	*	3/94-
			ОМЕГА B 3,2 I M6 24M	Y32SE		G	MA	*	00/9-
ОРОМВ94-912	6302005	63074	ОМЕГА '94-99 РАДИАТОР ОХЛАЖДЕН АТ МТ БЕЗ КОНДИЦ 2.5 (турбодизель) (NISSENS)						653 460 42
			ОМЕГА 2,5TD			D	MA		94/4-
			ОМЕГА B 2,5TD	U25TD		D	MA		3/94-
			ОМЕГА B 2,5TD	X25TD		D	MA		3/94-
			ОМЕГА B 2,5TD	Y25TD		D	MA		3/94-
ОРОМВ94-913	6302004	63075	ОМЕГА '94-99 РАДИАТОР ОХЛАЖДЕН (NISSENS)						653 460 42
			ОМЕГА B 2,5TD	U25TD		D	MA	*	3/94-
			ОМЕГА B 2,5TD	X25TD		D	MA	*	3/94-
			ОМЕГА B 2,5TD	Y25TD		D	MA	*	3/94-
ОРОМВ96-910	1300165	63076	ОМЕГА '96-99 РАДИАТОР ОХЛАЖДЕН (NISSENS)						653 460 27
			ОМЕГА B 2,5i/24V	X25XE		G	MA		/96-
			ОМЕГА B 3,0i/24V	X30XE		G	MA		/96-

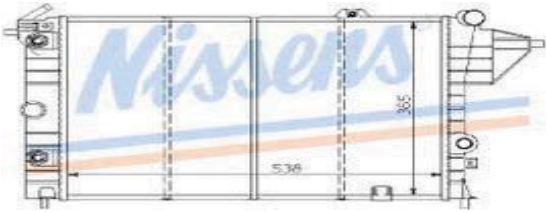
№ ФОРВАРДА	№ OEM	№ NISSENS	МОДЕЛЬ	ТИП ДВИГАТЕЛЯ	БЕН/Д ИЗ	ТИП КП	КОНД ИЦИ	ГОД	ПРИМЕЧА НИЕ
ОРVCA02-910	1300244	63024A	VECTRA '02- {+SIGNUM} РАДИАТОР ОХЛАЖДЕНИЯ (NISSENS)						647 399 26
ОРVCA02-912	1300244	63024	VECTRA '02- {+SIGNUM} РАДИАТОР ОХЛАЖДЕН						647 399 26
			SIGNUM 1,8i 16V SIGNUM 1,8i 16V VECTRA C 1,6i 16V VECTRA C 1,8i 16V VECTRA C 1,8i 16V	1796 Z18XE 1797 Z18XEL 1598Z16XE 1796Z18XE 1796Z18XEL	G	M	*	02/4-	
ОРVCA02-911	51770411/1300247	63023	VECTRA '02- РАДИАТОР (NISSENS)						650 415 27
			CROMA 2,2i 16V SIGNUM 3,2i V6 24V SIGNUM 2,0 16V DTi SIGNUM 2,2 16V DTi SIGNUM 2,2i 16V SIGNUM 2,2i 16V SIGNUM 2,2i 16V VECTRA C 2,0 16V DTi VECTRA C 2,2 16V DTi VECTRA C 2,2i 16V VECTRA C 2,2i 16V VECTRA C 2,2i 16V VECTRA C 2,2i 16V VECTRA C 3,2i V6 24V	194 A1 000 3175Z32SE 1995Y20DTH 2172Y22DTR 2198Z22SE 2198Z22SE 2198Z22YH 1995Y20DTH 2172Y22DTR 2198Z22SE 2198Z22SE 2198Z22SE 2198Z22YH 3175Z32SE	G	A	*/-	05/01-	
ОРVCA88-910	1300084	63054	VECTRA '88-95 РАДИАТОР ОХЛАЖДЕН (NISSENS)						538 365 33
ОРVCA88-919		63054	VECTRA '88-95 РАДИАТОР ОХЛАЖДЕН						538 365 33
			CALIBRA 2,0 16V CALIBRA 2,0i CAVALIER C 1,7D CAVALIER C 1,8S/I CAVALIER C 2,0 16V CAVALIER C 2,0i VECTRA A 1,7D VECTRA A 1,8S/I VECTRA A 2,0 16V VECTRA A 2,0i	1988C20XE 1988C20NE 169917D 1796 1998C20XE 1998C20NE 17D 18SV/C18NZ/E18N C20XE 20SEH	G	M		9/90-	
ОРVCA88-911	1300097/122/090	630551	VECTRA '88-95 РАДИАТОР ОХЛАЖДЕН (NISSENS)						538 365 33
			CAVALIER C 1,7D CAVALIER C 1,8S/I CAVALIER C 2,0i VECTRA A 1,7D VECTRA A 1,8S/I VECTRA A 2,0 16V VECTRA A 2,0i	169917D 1796 1998C20NE 17D 18SV/C18NZ/E18N C20XE 20SEH	D	A		9/88-	

№ФОРВАРДА	№ OEM	№ NISSENS	МОДЕЛЬ	ТИП ДВИГАТЕЛЯ	БЕН/Д ИЗ	ТИП КП	КОНД ИЦИ	ГОД	ПРИМЕЧА НИЕ
OPVCA88-912	1300135/133	63064A	VECTRA '88- {CALIBRA 90-} РАДИАТОР ОХЛАЖДЕН (NISSENS)						617 368 32
OPVCA88-916		63064A	VECTRA '88-95 {CALIBRA 91-} РАДИАТОР ОХЛАЖДЕН						617 368 32
OPVCA89-911	1300135/133	63064	VECTRA '88-95 {CALIBRA 90-} РАДИАТОР ОХЛАЖДЕН						617 368 32
			CALIBRA 2,0I	C20NE	G	A	*/-	3/90-	
			CALIBRA 2,0I/16V	C20XE	G	A	*	3/90-	
			CALIBRA 2,0I/16V	198820NE/SEH/C20NE	G	A	*/-	9/90-	
			CAVALIER C 1,6S/I	159816SV/C16NZ	G	A	*	9/88-	
			CAVALIER C 1,7D	169917D	D	A	*	9/88-	
			CAVALIER C 1,8S/I	179618SV/C18NZ/E18N	G	A	*	9/88-	
			CAVALIER C 2,0I	1998C20NE	G	A	*	9/88-	
			VECTRA A 1,4S/I	14NV	G	MA	*	10/90-9/95	
			VECTRA A 1,6S/I	16SV/C16NZ	G	A	*	9/88-9/95	
			VECTRA A 1,7D	17D	D	A	*	9/88-9/95	
			VECTRA A 1,8S/I	18SV/C18NZ/E18N	G	A	*	9/88-9/95	
			VECTRA A 2,0 16V	C20XE	G	A	*	9/88-9/95	
			VECTRA A 2,0I	20SEH	G	A	*	9/88-9/95	
OPVCA88-913	1300088	63225	VECTRA '88-95 РАДИАТОР ОХЛАЖДЕН (NISSENS)						525 322 32
			CAVALIER C 1,6S/I	159816SV/C16NZ	G	A		9/88-	
			VECTRA A 1,6S/I	16SV/C16NZ	G	A		9/88-9/95	
			VECTRA A 1,6S/I	X16SZ	G	A		9/88-9/95	
OPVCA88-914	1300092/135/107	63063A	VECTRA '88-95 РАДИАТОР ОХЛАЖДЕН (NISSENS)						617 368 32
OPVCA88-917		63063	VECTRA '88-95 {+ CALIBRA 90-} РАДИАТОР ОХЛАЖДЕН						616 368 32
			CALIBRA 2,0I	C20NE	G	M	*/-	3/90-	
			CALIBRA 2,0I/16V	C20XE	G	M	*	3/90-	
			CALIBRA 2,0I/16V	198820NE/SEH/C20NE	G	M	*/-	9/90-	
			CAVALIER C 1,4S/I	139614NV	G	M	*	9/88-	
			CAVALIER C 1,6S/I	159816SV/C16NZ	G	M	*	9/88-	
			CAVALIER C 1,7D	169917D	D	M	*	9/88-	
			CAVALIER C 1,8S/I	179618SV/C18NZ/E18N	G	M	*	9/88-	
			CAVALIER C 2,0I	1998C20NE	G	M	*	9/88-	
			VECTRA A 1,4S/I	14NV	G	M	*	9/88-10/90	
			VECTRA A 1,6S/I	16SV/C16NZ	G	M	*	9/88-9/95	
			VECTRA A 1,7D	17D	D	M	*	9/88-9/95	
			VECTRA A 1,8S/I	18SV/C18NZ/E18N	G	M	*	9/88-9/95	
			VECTRA A 2,0 16V	C20XE	G	M	*	9/88-9/95	
		VECTRA A 2,0I	20SEH	G	M	*	9/88-9/95		
OPVCA88-915	90264491	63223A	VECTRA '88-95 РАДИАТОР ОХЛАЖДЕН (NISSENS)						525 325 22
OPVCA89-910	90264491	63223	VECTRA '88-95 РАДИАТОР ОХЛАЖДЕН						525 325 22
			CAVALIER C 1,4S/I	139614NV	G	M		9/88-	
			CAVALIER C 1,6S/I	159816SV/C16NZ	G	M		9/88-	
			VECTRA A 1,4S/I	14NV	G	M		9/88-	
			VECTRA A 1,6S/I	16SV/C16NZ	G	M		9/88-9/95	
			VECTRA A 2,0I	20SEH	G	A	*	9/88-9/95	

№ ФОРВАРДА	№ OEM	№ NISSENS	МОДЕЛЬ	ТИП ДВИГАТЕЛЯ	БЕН/Д ИЗ	ТИП КП	КОНД ИЦИ	ГОД	ПРИМЕЧА НИЕ	
OPVCA88-918		63055	VECTRA 88- РАДИАТОР ОХЛАЖДЕН						538 365 33	
			VECTRA A (88-) 1.8 i	C18NZ	G	A	-	09/88 - 09/95		
			VECTRA A (88-) 2.0 i	20SEH	G	A	-	09/88 - 09/95		
			VECTRA A (88-) 2.0 i	C20NE	G	A	-	09/88 - 09/95		
			VECTRA A (88-) 2.0 i 16V	C20XE	G	A	-	09/88 - 09/95		
			VECTRA A (88-) 2.0 i 16V	X20XEV	G	A	-	09/88 - 09/95		
			VECTRA A (88-) 1.7 D	17D	D	A	-	09/88 - 09/95		
			VECTRA A (88-) 1.7 D	17DR	D	A	-	09/88 - 09/95		
			CAVALIER (88-) 1.8 i	C18NZ	G	A	-	09/88 - 09/95		
			CAVALIER (88-) 2.0 i	20SEH	G	A	-	09/88 - 09/95		
			CAVALIER (88-) 2.0 i	C20NE	G	A	-	09/88 - 09/95		
			CAVALIER (88-) 2.0 i 16V	C20XE	G	A	-	09/88 - 09/95		
			CAVALIER (88-) 2.0 i 16V	X20XEV	G	A	-	09/88 - 09/95		
			CAVALIER (88-) 1.7 D	17D	D	A	-	09/88 - 09/95		
			CAVALIER (88-) 1.7 D	17DR	D	A	-	09/88 - 09/95		
OPVCA96-910	90528302	63068A	VECTRA *96- РАДИАТОР ОХЛАЖДЕН (NISSENS)						537 379 22	
OPVCA96-916	90528302	63068	VECTRA *96- РАДИАТОР ОХЛАЖДЕН						537 359 22	
			VECTRA 1,6	159816LZR	G	M		10/95-		
			VECTRA 1,6 16V	1598X16XEL	G	M		10/95-		
			VECTRA 1,6i	1598X16XEL	G	M		10/95-		
			VECTRA 1,8 16V	1796X18XE	G	M		10/95-		
			VECTRA 2,0 16V	1998X20XEV	G	M		10/95-		
			VECTRA 2,0i	199820NEJ	G	M		10/95-		
			VECTRA B 2,0i	199820NEJ	G	M		10/95-		
			VECTRA B 2,0i/16V	1998X20XEV	G	M		10/95-		
OPVCA96-911	1300158	63069A	VECTRA *96- РАДИАТОР ОХЛАЖДЕН (NISSENS)						537 379 22	
OPVCA96-917		63069	VECTRA *96- РАДИАТОР ОХЛАЖДЕН						537 359 23	
			VECTRA 1,6/1,6i/16V	159816LZR/X16SZR/XE	G	A		10/95-		
			VECTRA 1,8 16V	1796X18XE	G	A		10/95-		
			VECTRA 2,0i 16V	199820NEJ/X20XEV	G	A		10/95-		
			VECTRA B 1,6i	1598X16SZR	G	A		10/95-1/99		
			VECTRA B 1,6i 16V	1598X16XEL	G	A		10/95-		
			VECTRA B 1,8i 16V	1796X18XE	G	A		10/95-		
			VECTRA B 2,0i	199820NEJ	G	A		10/95-		
			VECTRA B 2,0i 16V	1998X20XEV	G	A		10/95-		
OPVCA96-912	1300161/52464543	63078A	VECTRA *96- РАДИАТОР ОХЛАЖДЕН (NISSENS)						540 378 0	
			VECTRA B 2,0D	1998X20DTL	D	A	*			
			VECTRA B 2,5 i V6 24V	2490X25XE	G	A	*			
			VECTRA B 2,5i 24V	1998 20NEJ/X20XEV	G	A	*			
			VECTRA B 2,6 i V6 24V	2588Y26SE	G	A	*	10/95-		

№ФОРВАРДА	№ OEM	№ NISSENS	МОДЕЛЬ	ТИП ДВИГАТЕЛЯ	БЕН/Д ИЗ	ТИП КП	КОНД ИЦИ	ГОД	ПРИМЕЧА НИЕ
ОРVCA96-913	1300160/159/52464524/43/73	63077A	VECTRA '96- РАДИАТОР ОХЛАЖДЕН (NISSENS)						540 378 0
ОРVCA96-915	1300160/159/52464524/43/73	63077A	VECTRA '96- РАДИАТОР ОХЛАЖДЕН						540 378 0
			VECTRA B 1,6	159816LZ2	G	A	*	10/95-	
			VECTRA B 1,6i	1598X16SZR	G	A	*	10/95-1/99	
			VECTRA B 1,6i 16V	1598X16XEL	G	A	*	10/95-	
			VECTRA B 1,8i 16V	1796X18XE	G	A	*	10/95-	
			VECTRA B 2,0D	1998X20DTL	D	A	*	10/95-	
			VECTRA B 2,0i	199820NEJ	G	A	*	10/95-	
			VECTRA B 2,0i/16V	1998X20XEY	G	A	*	10/95-	
			VECTRA B 2,5i/16V	2490X25XE	G	A	*	10/95-	
ОРVCA96-914	1300185/24252479098/52492109	630121	VECTRA '96-РАДИАТОР ОХЛАЖДЕНИЯ (NISSENS)						608 377 26
ОРVCA96-918		63012	VECTRA '96- РАДИАТОР ОХЛАЖДЕН						608 377 26
			VECTRA 1,6	1598X16SZR	G	M	*	10/95-3/02	
			VECTRA 1,6 I	1598X16XEL	G	M	*	10/95-1/99	
			VECTRA 1,6 I 16V	1598X16XEL	G	M	*	10/95-3/02	
			VECTRA 1,8 I 16V	1598X16XEL	G	M	*	10/95-3/02	
			VECTRA 2,0 D	1998X20DTL	D	M	*	10/95-3/02	
			VECTRA 2,0 I	1998 20NEJ	G	M	*	10/95-6/00	
			VECTRA 2,0 I 16V	1998 20NEJ	G	M	*	10/95-6/00	
			VECTRA 2,2 I 16V	1998 20NEJ	G	M	*	7/00-3/02	
			VECTRA B 1,6	1598 16LZ2	G	M	*	10/95-3/02	
			VECTRA B 1,6 I	1598X16SZR	G	M	*	10/95-1/99	
			VECTRA B 1,6 I 16V	1598X16XEL	G	M	*	10/95-3/02	
			VECTRA B 1,8 I 16V	1796X18XE	G	M	*	10/95-3/02	
			VECTRA B 2,0 I	1998 20NEJ	G	M	*	10/95-6/00	
			VECTRA B 2,0 I 16V	1998X20XEY	G	M	*	10/95-6/00	
			VECTRA B 2,0 TD	1998X20DTL	D	M	*	10/95-3/02	
		VECTRA B 2,0 TD	1998X20DTL	D	M	*/-	10/95-3/02		
		VECTRA B 2,2 I 16V	2198Z22SE	G	M	*	7/00-3/02		
PG20698-910	133040/133053/133065/1330B0/1330B1/1330E8/1330G1	63706A	206 '98-РАДИАТОР ОХЛАЖДЕНИЯ (NISSENS)						380 549 26
			PEUGEOT 206 1,4i	1360 TU3JP	G	A	*	99/3-01/3	
			PEUGEOT 206 1,4i	1360 TU3JP	G	A	*	98/9-01/3	
			PEUGEOT 206 1,4i	1360 TU3JP	G	A	*	01/3-02/11	
			PEUGEOT 206 1,4 Hdi	1398 D4D	D	M	*/-	02/3-	
			PEUGEOT 206 1,4 Hdi	1398 DV4TD	D	M	*/-	02/3-	
			PEUGEOT 206 1,6i 16V	1587 TU5JP4	G	M	*	01/3-02/11	
			PEUGEOT 206 1,6i 16V	1587 TU5JP4	G	M	*	98/9-01/3	
			PEUGEOT 206 1,6i 16V	1587 TU5JP4	G	M	*	01/2-02/11	
			PEUGEOT 206 1,6i 16V	1587 TU5JP4	G	A	*/-	98/9-01/3	
			PEUGEOT 206 1,6i 16V	1587 TU5JP4	G	A	*/-	01/03-04/6	
			PEUGEOT 206 1,6i 16V	1998 EW10J4	G	M	*	98/9-01/3	
			PEUGEOT 206 1,6i 16V	1998 EW10J4	G	M	*	01/3-01/6	
			PEUGEOT 206 1,9 D	1868 DW8B	D	M	*	98/9-01/3	
			PEUGEOT 206 1,9 D	1868 DW8B	D	M	*	01.03.2000	
			PEUGEOT 206 1,9 D	1870 DW8B	D	M	*	98/9-01/3	
			PEUGEOT 206 1,9 D	1870 DW8B	D	M	*	01/03-02/11	
			PEUGEOT 206 2,0 HDi	1997 DW10TD	D	M	*	98/9-01/03	
			PEUGEOT 206 2,0 HDi	1997 DW10TD	D	M	*	01/03-	
			PEUGEOT 206 2,0 HDi	1997 DW10TD	D	M	*	98/9-01/3	
			PEUGEOT 206 2,0 HDi	1997 DW10TD	D	M	*	01/03-02/11	
			PEUGEOT 206 2,0i 16V	1997 EW10J4	G	M	*	98/9-01/3	
			PEUGEOT 206 2,0i 16V	1998 EW10J4	G	M	*	01/3-	

№ФОРВАРДА	№ OEM	№ NISSENS	МОДЕЛЬ	ТИП ДВИГАТЕЛЯ	БЕН/Д ИЗ	ТИП КП	КОНД ИЦИ	ГОД	ПРИМЕЧА НИЕ
PG30700-910	1330G9/1330A2/1330E0	63689A	307 '00- {СТ С4 04-} РАДИАТОР ОХЛАЖДЕНИЯ (NISSENS)						380 549 26
			CITROEN C4 2.0i 16V	EW10J4S	G	M	*/-	04/11-	
			PEUGEOT 307 2.0 HDi	1997 DW10TD	D	M	*	01/3-03/10	
			PEUGEOT 307 2.0i 16V	1997 EW10J4S	G	M	*/-	01/03-03/10	
			PEUGEOT 307 2.0i 16V	1997 EW10J4S	G	M	*/-	03/10-05/06	

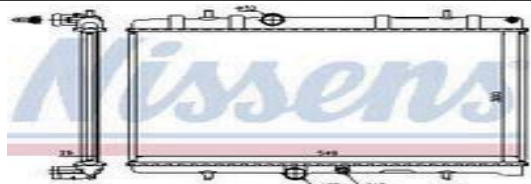

PG40587-910	1301G3/JQ/RL/RR	63528	405 '92- {PG 406 95-99} РАДИАТОР ОХЛАЖДЕНИЯ						610 377 23
			405 (92-) 1.4	TU3	G	M	-	07/92 -	
			405 (92-) 1.6	XU5M/2C	G	M	+	07/92 -	
			405 (92-) 1.8	XU7JP	G	M	+/-	07/92 -	
			405 (92-) 2.0	XU10J2	G	M	+/-	07/92 -	
			405 (92-) 2.0 M116	XU10J4	G	M	-	07/92 -	
			405 (92-) 1.9 D	XUD9	D	M	+/-	07/92 -	



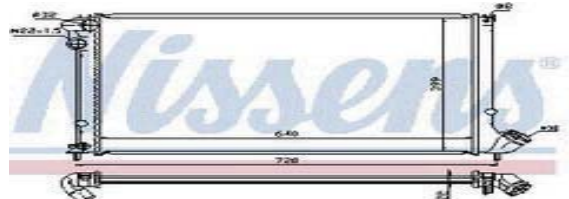

PG40696-910	1301GA	63731A	406 '96-04 РАДИАТОР ОХЛАЖДЕНИЯ (NISSENS)						640 399 22
			PEUGEOT 406 1,6i	1580 XU5JP	G	M	*	95/10-99/3	
			PEUGEOT 406 1,6i	1580 XU5JP	G	M	*	99/4-	
			PEUGEOT 406 1,8i	1761 XU7JP	G	M	*	95/9-99/4	
			PEUGEOT 406 1,8i	1761 XU7JB	G	M	*	99/4-	
			PEUGEOT 406 1,8i	1761 XU7JP	G	M	*	99/4-	
			PEUGEOT 406 1,8i 16V	1761 XU7JP4	G	M	*	1996/7-99/3	

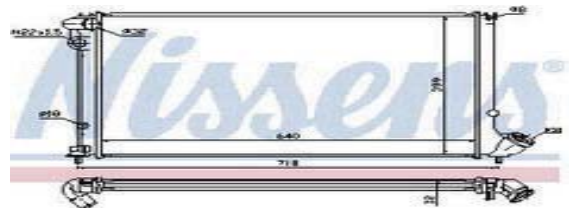

PG40696-911	1301FP	63732A	406 '96-99 РАДИАТОР ОХЛАЖДЕНИЯ (NISSENS)						640 415 32
PG40696-913	1301FP	63732	406 '96-99 РАДИАТОР ОХЛАЖДЕНИЯ						640 415 32
			PEUGEOT 406 1,8i	1761 XU7JP	G	A	*	95/9-99/4	
			PEUGEOT 406 1,8i 16V	1761 XU7JP4	G	A	*	96/7-99/3	
			PEUGEOT 406 2,0i 16V	1998 XU10J4R	G	A	*	95/10-99/4	
			PEUGEOT 406 COUPE 2,0i 16V	1998 XU10J4R	G	A	*	97/10-99/4	

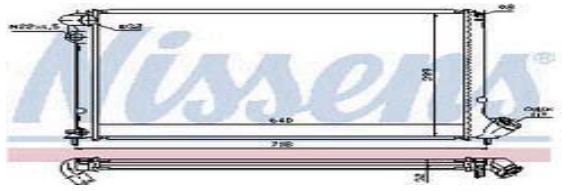
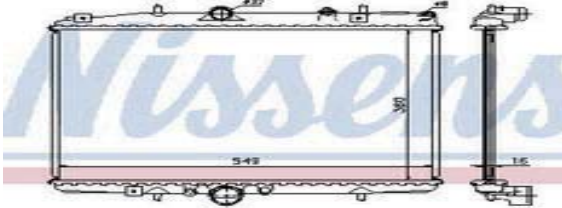

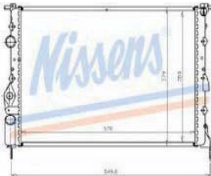
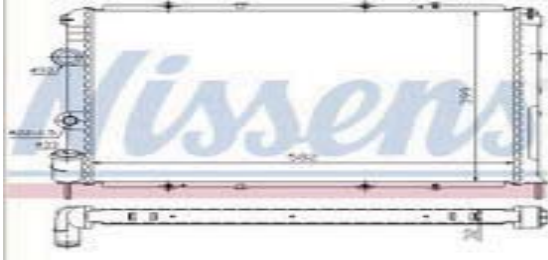
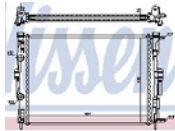

№ФОРВАРДА	№ OEM	№ NISSENS	МОДЕЛЬ	ТИП ДВИГАТЕЛЯ	БЕН/Д ИЗ	ТИП КП	КОНД ИЦИ	ГОД	ПРИМЕЧА НИЕ
PG40696-912	1301GE	63733A	406 '96-99 РАДИАТОР ОХЛАЖДЕНИЯ (NISSENS)						640 399 32
PG40696-914		63733	406 '96-99 РАДИАТОР ОХЛАЖДЕН						640 399 32
			PEUGEOT 406 2,0i	1998 XU10J4R	G	M	*	95/10-99/04	
			PEUGEOT 406 2,0i 16V	1998 XU10J4R	G	M	*	95/10-99/04	
			PEUGEOT 406 COUPE 2,0i 16V	1998 XU10J4R	G	M	*	97/10-99/4	
									
PG40699-910	133068/1331GV	61291A	406 '99- {+СТ С5 00-} РАДИАТОР ОХЛАЖДЕНИЯ (NISSENS)						380 550 14
			406 1,8i 16V	1749 EW7J4	G	M	*	99/4-	
			406 1,8i 16V	1761 XU7JP4	G	M	*	99/4-	
			406 2,0 Hdi	1997 DW10ATED/TD	D	M	*	99/4-	
			C5 1,8i 16V	1749 EW7J4	G	M	*	00/6-	
									
RNCL198-913	7700428082	63793	CLIO'04- {+SYMBOL 98- /KANGOO 98- /LOGAN 04-} РАДИАТОР ОХЛАЖДЕН						480 413 24
			LOGAN (04-) 1.4 i	K7J	G	M	+	09/04 -	
			LOGAN (04-) 1.6 i	K7M	G	M	+	09/04 -	
			LOGAN (04-) 1.6 i 16V	K4M	G	M	+	09/04 -	
			APRIO (04-) 1.6 i	K7M	G	M	+	09/04 -	
			APRIO (04-) 1.6 i 16V	K4M	G	M	+	09/04 -	
			KUBISTAR (03-) 1.6 i 16V	K4M	G	M	-	08/03 -	
			PLATINA (01-) 1.4 i	K7J	G	M	+	04/01 -	
			PLATINA (01-) 1.4 i	K7J	G	A	+	04/01 -	
			CLIO (98-) 1.4 i 16V	K4J	G	M/A	+	10/99 -	
			CLIO (98-) 1.9 dTi	F8Q	D	M	-	11/99 -	
			CLIO (01-) 1.0 i	D7D	G	M	+	04/01 -	
			CLIO (01-) 1.2 i	D7F	G	M/A	+	04/01 - 03/03	
			CLIO (01-) 1.2 i 16V	D4F	G	M/A	+	04/01 - 03/03	
			CLIO (01-) 1.4 i	K7J	G	M	+	04/01 -	
			CLIO (01-) 1.4 i	K7J	G	A	+	04/01 -	
			CLIO (01-) 1.6 i 16V	K4M	G	M/A	+	04/01 - 03/03	
			CLIO (01-) 1.9 dTi	F9Q	D	M	+	04/01 -	
			CLIO SYMBOL (01-) 1.4 i	K7J	G	M	+	04/01 -	
			CLIO SYMBOL (01-) 1.4 i	K7J	G	A	+	04/01 -	
			KANGOO (98-) 1.2 i 16V	D4D	G	M	-	01/98 -	
			KANGOO (98-) 1.6 i 16V	K4M	G	M/A	-	01/02 -	
			THALIA (01-) 1.4 i	K7J	G	M	+	04/01 -	
			THALIA (01-) 1.4 i	K7J	G	A	+	04/01 -	
									

№ФОРВАРДА	№ OEM	№ NISSENS	МОДЕЛЬ	ТИП ДВИГАТЕЛЯ	БЕН/Д ИЗ	ТИП КП	КОНД ИЦИ	ГОД	ПРИМЕЧА НИЕ
RNLAG94-910	7701038237	63832A	LAGUNA '94- (+ESPACE 96-) РАДИАТОР ОХЛАЖДЕНИЯ (NISSENS)						559 389 22
			AVANTIME 2,0 I	1998F3R	G	M/A	9/01-		
			ESPACE 2,0 I	1998F3R	G	M/A	12/96-		
			LAGUNA 1,6 I 16V	1598K4M	G	M	7/98-		
			LAGUNA 1,6 I 16V	1598K4M	G	M	7/98-		
			LAGUNA 1,8 I	1598K4M	G	M	1/94-		
			LAGUNA 1,8 I	1794F3R	G	M	1/94-		
			LAGUNA 1,8 I 16V	1783F4P	G	M	7/98-		
			LAGUNA 1,8 I 16V	1783F4P	G	M	7/98-		
			LAGUNA 2,0 I	1998F3R	G	M	1/94-7/98		
			LAGUNA 2,0 I	1998F3R	G	M	1/94-7/98		
			LAGUNA 2,0 I	1998F3R	G	A	1/94-7/98		
			LAGUNA 2,0 I	1998F3R	G	A	1/94-7/98		
			LAGUNA 2,0 I 16 V	1943N7Q	G	M	3/95-		
			LAGUNA 2,0 I 16 V	1943N7Q	G	M	3/95-		
			LAGUNA 2,0 I 16 V	1998F4R	G	M	3/95-		
			LAGUNA 2,0 I 16 V	1998F4R	G	M	3/95-		
RNLAG94-911	6025310088/6025411680/7701038219/7701043411/7701044076	63851A	LAGUNA '94- (+ESPACE 96-) РАДИАТОР ОХЛАЖДЕНИЯ (NISSENS)						636 439 47
			AVANTIME 3,0 I V6	2963Z7X	G	A	*	9/01-	
			AVANTIME 3,0 I V6 24V	2963L7X	G	A	*	9/01-	
			AVANTIME 3,0 I V6 24V	2963L7X	G	A	*	12/96-	
			ESPACE 3,0 I V6	2963Z7X	G	A	*	1/97-	
			LAGUNA 1,8 I	1794F3R	G	M	*	1/94-2/98	
			LAGUNA 1,8 I	1794F3R	G	M	*	2/98-	
			LAGUNA 1,8 I	1794F3R	G	M	*	2/98-	
			LAGUNA 1,8 I	1794F3R	G	M	*	1/94-2/98	
			LAGUNA 2,0 I	1998F3R	G	M	*	1/94-7/98	
			LAGUNA 2,0 I	1998F3R	G	M	*	7/98-	
			LAGUNA 2,0 I	1998F3R	G	M	*	1/94-7/98	
			LAGUNA 2,0 I	1998F3R	G	M	*	1/94-7/98	
			LAGUNA 2,0 I	1998F3R	G	M	*/-	7/98-	
			LAGUNA 2,0 I	1998F3R	G	M	*/-	1/94-7/98	
			LAGUNA 2,0 I	1998F3R	G	A	*/-	1/94-7/98	
			LAGUNA 2,0 I	1998F3R	G	A	*/-	7/98-	
			LAGUNA 2,2 D	2188G8T	D	M	*/-	8/94-7/98	
			LAGUNA 2,2 D	2188G8T	D	M	*/-	7/98-	
			LAGUNA 2,2 D	2188G8T	D	M	*/-	8/94-7/98	
			LAGUNA 2,2 D	2188G8T	D	M	*/-	7/98-	
LAGUNA 3,0 I V6 24V	2946L7X	G	M/A	*/-	1/97-7/98				
LAGUNA 3,0 I V6 24V	2946L7X	G	M/A	*/-	7/98-				
LAGUNA 3,0 I V6 24V	2946L7X	G	M/A	*/-	1/97-7/98				
LAGUNA 3,0 I V6 24V	2946L7X	G	M/A	*/-	7/98-				
RNMEG95-910	7700838134	63937A	MEGANE '95- РАДИАТОР ОХЛАЖДЕНИЯ (NISSENS)						430 349 22
RNMEG95-913	7700838134	63937A	MEGANE '95- РАДИАТОР ОХЛАЖДЕНИЯ						430 349 22
			CLIO 1,0i	999D7D	G	M		01/4-	
			CLIO 1,2i	1149D7F	G	M/A		01/4-	
			CLIO 1,2i 16V	1149D4D	G	M/A		01/4-	
			CLIO 1,2i 16V	1149D4F	G	M/A		01/4-	
			CLIO 1,4i	1390 E7J	G	M/A		98/10-	
			CLIO 1,4i	1390 K7J	G	M/A		01/4-	
			CLIO 1,4i	1390 K4J	G	M/A		01/4-	
			CLIO 1,4i 16V	1390 K4J	G	M/A		98/10-	
			CLIO 1,4i 16V	1390 K4J	G	M/A		01/4-	
			CLIO 1,4i 16V	1390 K7J	G	M/A		01/4-	
			CLIO 1,6i	1580 K7M	G	M/A		98/10-	
			CLIO 1,6i 16V	1580 K4M	G	M/A		98/10-	
			CLIO 1,6i 16V	1598 K4M	G	M/A		01/4-	
			KANGOO 1,2 16V	1149 D4F	G	M		98/1-	

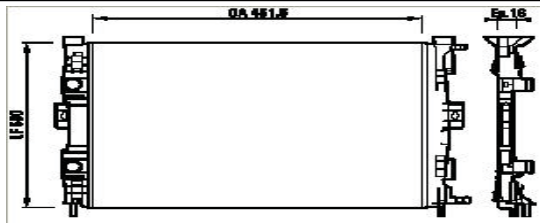
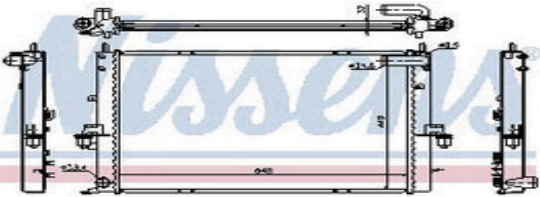
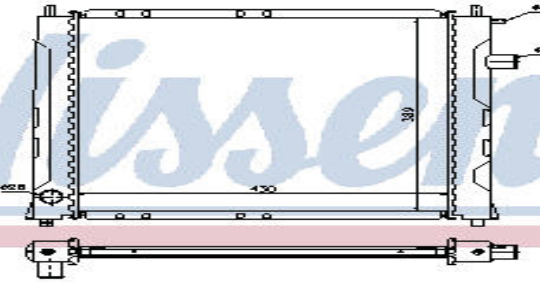
№ФОРВАРДА	№ OEM	№ NISSENS	МОДЕЛЬ	ТИП ДВИГАТЕЛЯ	БЕН/Д ИЗ	ТИП КП	КОНД ИЦИ	ГОД	ПРИМЕЧА НИЕ
			KANGOO 1,4	1390 E7J	G	M		98/1	
			MEGANE 1,4 i	1390 E7J	G	M		95/11-02/8	
			MEGANE 1,4 i 16V	1390 K4J	G	M		95/11-02/8	
			MEGANE 1,6 i	1598 K7M	G	M/A		95/11-02/8	
			MEGANE SCENIC 1,4 i	1390 E7J	G	M		96/10-	
			MEGANE SCENIC 1,4 i 16V	1390 K4J	G	M/A		99/2	
			MEGANE SCENIC 1,6 i 16V	1598 K4M	G	M/A		6/10-	
			MEGANE SCENIC 1,6 i 16V	1598 K7M	G	M/A		96/10-	
			NISSAN KUBISTAR 1,2i 16V	1149 D4F	G	M		03/8-	
			THALIA 1,4i	1390 K7J	G	M/A		01/4-	
			THALIA 1,4i 16V	1390 K4J	G	M/A		01/4-	
RNMEG95-911	7700838135	63939A	MEGANE '95- РАДИАТОР ОХЛАЖДЕН (NISSENS)						570 379 22
RNMEG95-914	7700838135	63939A	MEGANE '95- РАДИАТОР ОХЛАЖДЕНИЯ						570 379 22
			MEGANE 1,6	1598K7M	G	A		11/95-	
			MEGANE 2,0	1998F3R	G	MA		11/95-	
			MEGANE SCENIC 1,4	1390E7J	G	M		9/96-	
			MEGANE SCENIC 1,6	1598K7M	G	M		9/96-	
			MEGANE SCENIC 2,0	1998F3R	G	M		9/96-	
RNMEG95-912	7700838133	63938A	MEGANE '95- (+SCENIC 96-) РАДИАТОР ОХЛАЖДЕНИЯ (NISSENS)						585 397 32
			MEGANE 1,4 I	1390E7J	G	M	*	11/95-4/98	
			MEGANE 1,6 I	1598K7M	G	M/A	*	11/95-4/98	
			MEGANE 1,9 DT	1870F8Q	D	M		11/95-8/02	
			MEGANE 2,0 I	1998F3R	G	M/A	*	11/95-5/98	
			MEGANE 2,0 I 16V	1998F7R	G	M/A	*	11/95-5/98	
			MEGANE SCENIC 1,4 I	1390E7J	G	M	*	10/96-4/98	
			MEGANE SCENIC 1,4 I	1390E7J	G	M	*	10/96-4/98	
			MEGANE SCENIC 1,6 I 16V	1598K7M	G	M/A	*	10/96-4/98	
			MEGANE SCENIC 1,6 I 16V	1598K7M	G	M/A	*	10/96-4/98	
			MEGANE SCENIC 1,9 D	1870F8Q	D	M		9/96-	
			MEGANE SCENIC 1,9 D	1870F8Q	D	M		9/96-	
			MEGANE SCENIC 1,9 DT	1870F8Q	D	M		9/96-8/98	
			MEGANE SCENIC 1,9 DT	1870F8Q	D	M		9/96-8/98	
			MEGANE SCENIC 1,9 DT I	1870F8Q	D	M/A	*	9/96-5/98	
			MEGANE SCENIC 1,9 DT I	1870F8Q	D	M/A	*	9/96-5/98	
			MEGANE SCENIC 2,0 I	1998F3R	G	M/A	*	10/96-4/98	
			MEGANE SCENIC 2,0 I	1998F3R	G	M/A	*	10/96-4/98	
RNMEG03-910	8200115542	63765A	MEGANE 03- (+ SCENIC 03-) РАДИАТОР ОХЛАЖДЕН (NISSENS)						587 430 26
			MEGANE 1,5 dCi	K9K	D	M	+/-	09/02 -	
			MEGANE 1,6 i 16V	K4M	G	A	+/-	09/02 -	
			MEGANE 1,9 dCi	F9Q	D	M	+/-	09/02 -	
			MEGANE 2,0 i 16V	F4R	G	M	+/-	09/02 -	
			SCENIC 1,5 dCi	K9K	D	M	+/-	06/03 -	
			SCENIC 1,6 i 16V	K4M	G	A	+/-	06/03 -	
			SCENIC 1,9 dCi	F9Q	D	M	+/-	06/03 -	
			SCENIC 2,0 i 16V	F4R	G	M	+/-	06/03 -	

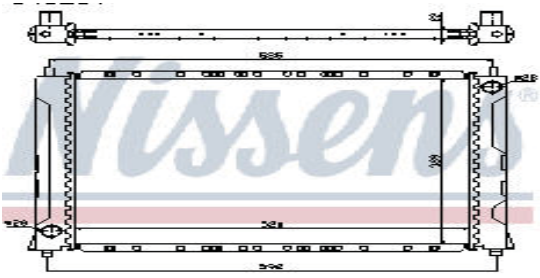
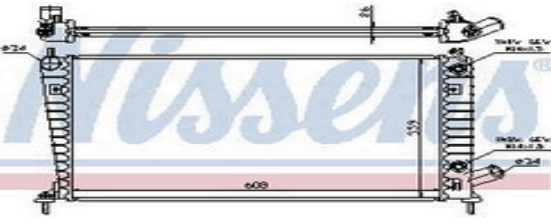
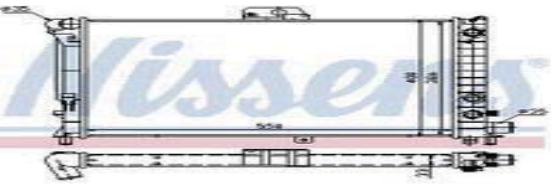
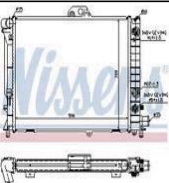
№ФОРВАРДА	№ OEM	№ NISSENS	МОДЕЛЬ	ТИП ДВИГАТЕЛЯ	БЕН/Д ИЗ	ТИП КП	КОНД ИЦИ	ГОД	ПРИМЕЧА НИЕ
RNMEG03-911	8200115541	63764	MEGANE 03- (+ SCENIC 03-) РАДИАТОР ОХЛАЖДЕН (NISSENS)						588 450 18
			MEGANE 1.4 i 16V	K4J	G	M	+/-	09/02 -	
			MEGANE 1.6 i 16V	K4M	G	M	+/-	09/02 -	
			SCENIC 1.4 i 16V	K4J	G	M	+/-	06/03 -	
			SCENIC 1.6 i 16V	K4M	G	M	+/-	06/03 -	
RVR7599-910	GRD1055/PCC000960	64308A	ROVER 75 '99- РАДИАТОР ОХЛАЖДЕНИЯ (NISSENS)						648 449 32
			MG ZT 1, 8i 16V	1796 18K4F	G	M/A	*	01/9-	
			MG ZT 1,8i TURBO	1797 18K4F	G	M/A	*/-	01/9-	
			MG ZT 2,0 CDTi	1951 204D2	D	M/A	*/-	01/9-	
			MG ZT 2,0i V6 24V	1991 V20K4F	G	M/A	*/-	01/9-	
			MG ZT 2,5i V6 24V	2497 25K4F	G	M/A	*/-	01/9-	
			MG ZT4 6i V8		G	M/A	*/-	01/9-	
			MG ZTT 1,8i 16V	1796 18K4F	G	M/A	*/-	01/9-	
			MG ZTT 1,8i TURBO	1797 18K4F	G	M/A	*/-	01/9-	
			MG ZTT 2,0CDTi	1951 204D2	D	M/A	*/-	01/9-	
			MG ZTT 2,0i V6 24 V	1991 V20K4F	G	M/A	*/-	01/9-	
			MG ZTT 2,5i V6 24 V	2497 25K4F	G	M/A	*/-	01/9-	
			MG ZTT4 6i V8		G	M/A	*/-	01/9-	
			ROVER 75 1,8i 16V	1796 18K4F	G	M/A	*/-	99/3-	
			ROVER 75 1,8i TURBO	1796 18K4F	G	M/A	*/-	99/3-	
			ROVER 75 2,0 CDTi	1951 204D2	D	M/A	*/-	99/3-	
			ROVER 75 2,0i V6 24V	1991 V20K4F	G	M/A	*/-	99/3-	
			ROVER 75 2,5i V6 24V	2497 25K4F	G	M/A	*/-	99/3-	
			ROVER 75 4,6i V8		G	M/A	*/-	99/3-	
RV20095-910	GRD1072/GRD938/PCC001180/480/4410	642091	ROVER 200 95- (+ 400/ 25 99- / 45 99-) РАДИАТОР ОХЛАЖДЕН (NISSENS)						430 389 22
RV20095-912	GRD1072/GRD938/PCC001180/480/4410	64209	ROVER 200 95- (+ 400/ 25 99- / 45 99-) РАДИАТОР ОХЛАЖДЕН						430 389 21
			ZR 1.1 i	11K2F	G	M	-	09/01 -	
			ZR 1.4 i	14K4F	G	M	-	09/01 - 11/04	
			ZR 1.6 i	16K4F	G	M	-	09/01 - 11/04	
			ZR 1.8 i	18K4FL32	G	M/A	-	09/01 - 11/04	
			ZS 1.4 i	14K4F	G	M	-	09/01 -	
			ZS 1.6 i	16K4F	G	M	-	09/01 -	
			ZS 1.8 i	18K4F	G	M	-	09/01 -	
			200 1.4 i	14K14	G	M	-	09/95 - 11/99	
			200 1.6 i	16K16	G	M	-	09/95 - 11/99	
			25 1.1 i	11K2F	G	M	-	09/99 -	
			25 1.4 i	14K4F	G	M	-	07/99 - 11/04	
			25 1.6 i	16K4F	G	M	-	07/99 - 11/04	
			25 1.8 i	18K4F	G	M/A	-	07/99 - 11/04	
			400 1.4 i	14K14	G	M	-	09/95 - 11/99	
			400 1.6 i	16K16	G	M	-	09/95 - 11/99	
			400 1.8 i	18K4FL32	G	M	-	09/95 - 11/99	
			45 1.4 i	14K4F	G	M	-	09/99 -	
			45 1.6 i	16K4F	G	M	-	09/99 -	
			45 1.8 i	18K4F	G	M	-	09/99 -	

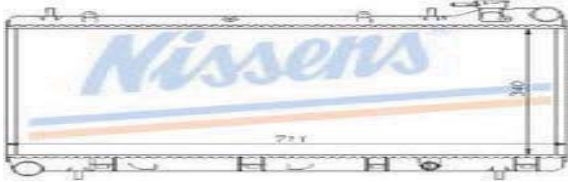
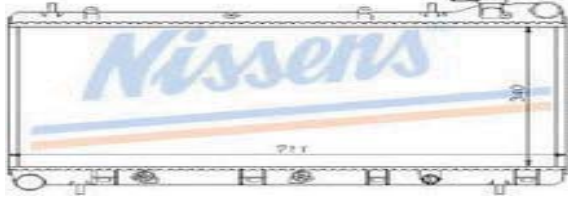
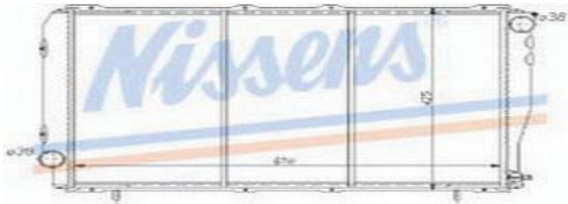
№ФОРВАРДА	№ OEM	№ NISSENS	МОДЕЛЬ	ТИП ДВИГАТЕЛЯ	БЕН/Д ИЗ	ТИП КП	КОНД ИЦИ	ГОД	ПРИМЕЧА НИЕ
RV20095-911	GRD125/GRD931	64026	ROVER 200 {+ 200 89-95-/400 89-} РАДИАТОР ОХЛАЖДЕН (NISSENS)						520 388 21
			CONCERTO (89-) 1.6 16V	D16 Z1	G	M	+/-	10/90 -	
			CONCERTO (89-) 1.6 i 16V	D16 A8	G	M	+/-	10/90 -	
			CONCERTO (89-) 1.6 i 16V	D16 Z2	G	M	+/-	10/90 -	
			CONCERTO (89-) 1.6 i 16V	D16 Z4	G	M	+/-	10/90 -	
			200 (89-) 1.6 i	1598	G	M	+/-	10/89 - 09/95	
			200 (95-) 1.4 i	14K14	G	M	+	09/95 - 11/99	
			200 (95-) 1.6 i	16K16	G	M	+	09/95 - 11/99	
			200 (95-) 1.6 i	16K16	G	A	+/-	09/95 - 11/99	
			200 (95-) 1.8 i	18K16	G	M/A	-	09/95 - 11/99	
			200 (95-) 1.8 i	18K16	G	M/A	+	09/95 - 11/99	
400 (89-) 1.6 i	HONDA	G	M	+/-	10/89 - 09/95				
SA09597-910	4,57572E+14	68001A	SAAB 9-5 '97- РАДИАТОР ОХЛАЖДЕНИЯ (NISSENS)						608 359 26
			SAAB 9-5 2.3 16V TURBO	2290 B235L	G	A	*/-	97/6	
			SAAB 9-5 2.0 16V TURBO	1985 B 205L	G	A	*/-	97/6-	
			SAAB 9-5 2.0 16V TURBO	1985 B205R	G	A	*/-	98/6-	
SA9TH84-910	127550098/7550098	64047	SAAB 9000 '84-95 РАДИАТОР ОХЛАЖДЕНИЯ (NISSENS)						550 400 33
			SAAB 9000 2.0 16V	1985 B202i	G	M/A	*	93/10-94/6	
			SAAB 9000 2.0 TURBO 16V	1985 B 202T	G	A	*	84/9-93/9	
			SAAB 9000 2.3 TURBO 16V	2290 B234i	G	A	*	84/9-93/9	
			SAAB 9000 2,3i 16V	2290 B234i	G	M/A	*	93/10-94/9	
SA9TH94-910	4358040/4360327/7599194	64033A	SAAB 9000 '94- РАДИАТОР ОХЛАЖДЕНИЯ (NISSENS)						640 399 22
			SAAB 9000 2.0 16V	1985 BI 202i	G	M/A	*/-	94/6-	
			SAAB 9000 2.0 TURBO 16V	1985 B 204S	G	M/A	*/-	94/9-	
			SAAB 9000 2,3 16V	2290 B234i	G	M/A	*	94/9-	
			SAAB 9000 2,3 TURBO 16V	2290 B234i	G	M/A	*/-	93/9-	
			SAAB 9000 3,0iV6 24V	2962 B308	G	M/A	*/-	94/9-	

№ФОРВАРДА	№ OEM	№ NISSENS	МОДЕЛЬ	ТИП ДВИГАТЕЛЯ	БЕН/Д ИЗ	ТИП КП	КОНД ИЦИ	ГОД	ПРИМЕЧА НИЕ
SBIMP93-913	45111FC370/FC320/FA200/45199FA040	64185	IMPREZA '93-01 {FORESTER MT 2 98-} РАДИАТОР ОХЛАЖДЕН MT 1.6 1.8 2 (NISSENS)						340 711 17
			FORESTER 2,0	2,0	G	M		8/98-	
			FORESTER 2,0 TURBO	2,0	G	M		8/98-	
			IMPREZA 1,5 E-GC1	EJ15	G	M		11/92-	
			IMPREZA 1,6 E-GC4	EJ16	G	M		11/92-7/95	
			IMPREZA 1,6 E-GC4	EJ16	G	M		8/95-7/98	
			IMPREZA 1,6 E-GC4	EJ16	G	M		8/98-	
			IMPREZA 1,8 E-GC6	EJ18	G	M		8/95-7/98	
			IMPREZA 1,8 E-GC6	EJ18	G	M		11/92-7/95	
			IMPREZA 2,0	2,0	G	M		8/98-	
			IMPREZA 2,0	EJ20	G	M		8/95-7/98	
									
SBIMP93-914	45111FC360/300/340/45199FA030	64186	IMPREZA '93-01 {FORESTER AT 98-} РАДИАТОР ОХЛАЖДЕН AT 1.6 1.8 2 (NISSENS)						340 711 17
			FORESTER 2,0 TURBO	2,0	G	A		8/98-	
			IMPREZA 1,6 E-GC4	EJ16	G	A		8/93-7/95	
			IMPREZA 1,6 E-GC4	EJ16	G	A		8/95-7/98	
			IMPREZA 1,6 E-GC4	EJ16	G	A		8/98-	
			IMPREZA 1,8 E-GC6	EJ18	G	A		8/95-7/98	
			IMPREZA 1,8 E-GC6	EJ18	G	A		11/92-7/95	
			IMPREZA 2,0	2,0	G	A		8/98-	
			IMPREZA 2,0	EJ20	G	A		8/95-7/98	
									
SBIMP94-910	45111AA260/199AA170	64111	IMPREZA '94- {LEGASY 90-91} РАДИАТОР ОХЛАЖДЕН MT 2 (turbo) (NISSENS)						670 425 25
			IMPREZA 2,0 TURBO	EJ20	G	M	*/-	/94-	
			LEGACY BC-2,0 i TURBO	EJ20	G	M	*/-	2/90-4/91	
			LEGACY BC-2,0 i TURBO	EJ21	G	M	*/-	90/2-91/4	
									
SBLEG90-913	45199AA080	64087	LEGACY '90-94 РАДИАТОР ОХЛАЖДЕН MT 1.8 2 2.2 (NISSENS)						670 390 17
			LEGACY 2200 GX-4WD	EJ22	G	M		2/89-	
			LEGACY BC2-1,8	EJ18	G	M		2/89-4/90	
			LEGACY BC3-1,8	EJ18	G	M		2/89-	
			LEGACY BC4-2,0	EJ20	G	M		2/89-	
									

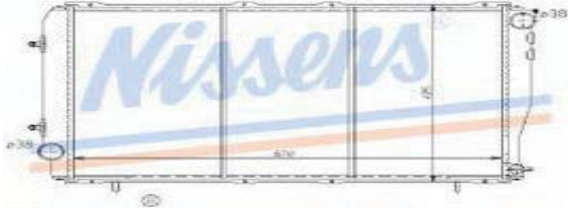
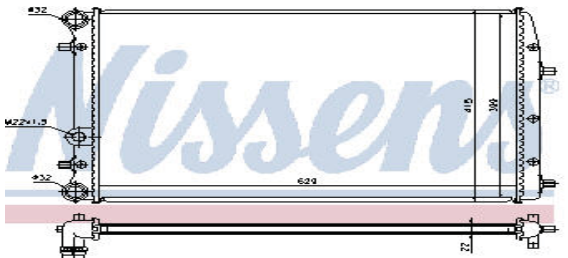
№ФОРВАРДА	№ OEM	№ NISSENS	МОДЕЛЬ	ТИП ДВИГАТЕЛЯ	БЕН/Д ИЗ	ТИП КП	КОНД ИЦИ	ГОД	ПРИМЕЧА НИЕ
SBLEG90-914	45199AA121	67700	LEGACY '90-94 РАДИАТОР ОХЛАЖДЕН АТ 1.8 2 (NISSENS)						670 390 17
			LEGACY BC2-1,8	EJ18	G	A		10/91-9/93	
			LEGACY BC3-1,8	EJ18	G	A		10/91-9/93	
			LEGACY BC4-2,0	EJ20	G	A		10/91-8/94	
SBLEG90-915	45199AA180	64099	LEGACY '90-94 РАДИАТОР ОХЛАЖДЕН АТ 2 (turbo) (NISSENS)						670 425 25
			LEGACY 2,0 TURBO	EJ20	G	A	*/-	2/89-	
			LEGACY 2,0 TURBO	EJ21	G	A	*/-	2/89-	
SDFAB99-910	6Q0121253R/Q	65271	FABIA 99- {POLO 01-/IBIZA01-/CORDOBA 02-} РАДИАТОР ОХЛАЖДЕН						631 417 23
			CORDOBA 1.2 i 12 V	AZQ/BME/BXV	G	M	+	10/02 -	
			CORDOBA 1.4 i 16V	BBY	G	A	+	09/02 -	
			CORDOBA 1.4 i 16V	BBY	G	M	+	09/02 -	
			CORDOBA 1.4 i 16V	BBZ/BXW	G	M	+	10/02 -	
			CORDOBA 1.4 i 16V	BKY	G	M/A	+	05/04 -	
			CORDOBA 1.4 TDi	AMF/BMS/BNM/BNV	D	M	+/-	10/02 -	
			CORDOBA 1.6 i	BAH	G	M	+	04/03 -	
			CORDOBA 1.6 i 16V	BTS	G	M	+	04/03 -	
			CORDOBA 1.9 Sdi	ASY	D	M	+/-	09/02 -	
			CORDOBA 1.9 TDi	ATD/AXR/BMT	D	M	+/-	09/02 -	
			CORDOBA 2.0 i	AZL	G	M	+/-	09/02 -	
			CORDOBA 2.0 i	BBX	G	M	+/-	04/03 -	
			IBIZA 1.2 i 12V	AZQ/BME	G	M	-	09/01 -	
			IBIZA 1.2 i 12V	AZQ/BME	G	M	+	09/01 -	
			IBIZA 1.4 i 16V	AUB/BBZ/BXW	G	M	+	09/01 -	
			IBIZA 1.4 i 16V	BBY/BKY	G	M/A	+	09/01 -	
			IBIZA 1.4 TDi	AMF/BMS/BNM/BNV	D	M	+/-	09/01 -	
			IBIZA 1.6 i	BAH	G	M	+	09/01 -	
			IBIZA 1.9 Sdi	ASY	D	M	+/-	09/01 -	
			IBIZA 1.9 TDi	ASZ/ATD/AXR/BLT	D	M	+/-	09/01 -	
IBIZA 2.0 i	AZL	G	M	+	09/01 -				
IBIZA 2.0 i	BBX	G	M	+	09/01 -				
FABIA 1.0 i	AQV/ARV	G	M	+	08/99 -				

№ФОРВАРДА	№ OEM	№ NISSENS	МОДЕЛЬ	ТИП ДВИГАТЕЛЯ	БЕН/Д ИЗ	ТИП КП	КОНД ИЦИ	ГОД	ПРИМЕЧА НИЕ
			FABIA 1.2 i	AWY/AZQ/BME/BMD	G	M	+	08/99 -	
			FABIA 1.4 i	AME/AQW/ATZ/AZE/AZF	G	M	+	08/99 -	
			FABIA 1.4 i 16V	AUA/BBY/BKY	G	A	+/-	08/99 -	
			FABIA 1.4 i 16V	AUA/AUB/BBY/BBZ/BBZ/BK	G	M	+	08/99 -	
			FABIA 2.0 i	AZL	G	M	+/-	08/99 -	
			FABIA 1.4 TDi	AMF/BNM/BNV	D	M	+/-	08/99 -	
			FABIA 1.9 Sdi	ASY	D	M	+/-	08/99 -	
			FABIA 1.9 TDi	ATD	D	M	+/-	08/99 -	
			ROOMSTER 1.0 i	BXW	G	M	+/-	03/06 -	
			ROOMSTER 1.2 i 12V	BME	G	M	+/-	03/06 -	
			ROOMSTER 1.4 i 16V	BMS	G	M	+/-	03/06 -	
			ROOMSTER 1.4 i 16V	BXW	G	M	+	03/06 -	
			ROOMSTER 1.4 TDi	BNM/BNV	D	M	+/-	03/06 -	
			ROOMSTER 1.6 i 16V	BTS	G	M	+/-	03/06 -	
			ROOMSTER 1.9 TDi	AXR/BLS/BSW	D	M	+/-	03/06 -	
			FOX 1.4 TDi	BNM	G	M	+/-	04/05 -	
			POLO 1.2 i	AWY	G	M	+	01/02 - 05/04	
			POLO 1.2 i	AZQ	G	M	+	11/01 - 05/04	
			POLO 1.2 i	BMD	G	M	+	05/04 -	
			POLO 1.2 i	BME	G	M	+	11/04 -	
			POLO 1.4 FSI	AXU	G	M	+	02/02 -	
			POLO 1.4 i 16V	AUA	G	M	+	11/01 - 01/02	
			POLO 1.4 i 16V	AUB	G	M	+	11/01 - 06/02	
			POLO 1.4 i 16V	BBY	G	M	+	11/01 - 05/04	
			POLO 1.4 i 16V	BBY	G	A	+/-	11/01 - 05/04	
			POLO 1.4 i 16V	BKY	G	M	+	05/04 -	
			POLO 1.4 i 16V	BKY	G	A	+/-	05/04 -	
			POLO 1.4 i 16V	BKY/BUD/BBZ	G	M	+	05/02 -	
			POLO 1.4 TDi	AMF/BAY/BMS/BNM/BNV/B	D	M	+/-	11/01 -	
			POLO 1.6 i 16V	BTS	G	M	+	05/02 -	
			POLO 1.9 Sdi	ASY	D	M	+/-	11/01 -	
			POLO 1.9 TDi	ATD/AXR/BMT	D	M	+/-	11/01 -	
			POLO SEDAN 1.4 i 16V	BBY/BBZ/BKY/BLM	G	M	+	07/03 -	
			POLO SEDAN 1.4 TDi	AMF/BAY	D	M	+/-	07/03 -	
			POLO SEDAN 1.9 Sdi	ASY	D	M	+/-	07/03 -	
			POLO SEDAN 1.9 TDi	ATD	D	M	+	07/03 -	
			POLO SEDAN 1.9 TDi	ATD	D	M	-	07/03 -	

SDFAB99-911 6Q0121253J 65269 FABIA '02- {POLO 01-/IBIZA01-/CORDOBA 02-} РАДИАТОР ОХЛАЖДЕН 430 406 22

			CORDOBA (02-) 1.2 i 12V	AZQ/BME/BXV	G	M	-	10/02 -	
			CORDOBA (02-) 1.4 i 16V	BBY	G	M	-	09/02 -	
			CORDOBA (02-) 1.4 i 16V	BBZ/BXW	G	M	-	10/02 -	
			CORDOBA (02-) 1.4 i 16V	BKY	G	M/A	-	05/04 -	
			CORDOBA (02-) 1.6 i	BAH	G	M	-	04/03 -	
			CORDOBA (02-) 1.6 i 16V	BTS	G	M	-	04/03 -	
			IBIZA (01-) 1.2 i 12V	AZQ/BME	G	M	-	09/01 -	
			IBIZA (01-) 1.4 i 16V	AUB/BBZ	G	M	-	09/01 -	
			IBIZA (01-) 1.4 i 16V	BBY/BKY	G	M/A	-	09/01 -	
			IBIZA (01-) 1.6 i	BAH	G	M	-	09/01 -	
			FABIA (99-) 1.0 i	AQV/ARV	G	M	-	08/99 -	
			FABIA (99-) 1.2 i	AWY/AZQ/BMD/BME	G	M	-	08/99 -	
			FABIA (99-) 1.4 i	AME/AZF/AZE/ATZ/AQW	G	M	-	08/99 -	
			FABIA (99-) 1.4 i 16V	AUA/BUD/BKY/BBZ/BBY/AI	G	M	-	08/99 -	
			POLO (01-) 1.2 i	AWY	G	M	-	01/02 - 05/04	
			POLO (01-) 1.2 i	AZQ/BME/BZG	G	M	-	11/01 - 05/04	
			POLO (01-) 1.2 i	BMD	G	M	-	05/04 -	
			POLO (01-) 1.4 FSI	AXU	G	M	-	02/02 -	
			POLO (01-) 1.4 i 16V	AUA/AUB/BBY	G	M	-	11/01 - 01/02	
			POLO (01-) 1.4 i 16V	BBZ/BKY/BUD/BTS	G	M	-	05/02 -	
			POLO SEDAN (04-) 1.4 i 16V	BBY/BBZ/BKY/BLM	G	M	-	07/03 -	

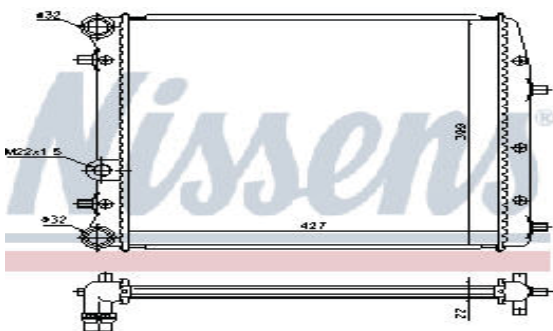

№ ФОРВАРДА	№ OEM	№ NISSENS	МОДЕЛЬ	ТИП ДВИГАТЕЛЯ	БЕН/Д ИЗ	ТИП КП	КОНД ИЦИ	ГОД	ПРИМЕЧА НИЕ
SDFEL94-911	6U0121253	64102	FELICIA '94-98 РАДИАТОР ОХЛАЖДЕН МТ 1.6 FELICIA 1,6	1598AEE	G	M		10/94-03/98	590 287 33



SDOCT96-910	1J0121253G/K	64101A	OCTAVIA '96-01 {VW BORA 98-/GOLF IV 97-/SE TOLEDO 99-} РАДИАТОР ОХЛАЖДЕН (NISSENS)						427 414 22
SDOCT96-911	1J0121253G/K	64101A	OCTAVIA '96-01 {VW BORA 98-/GOLF IV 97-/SE TOLEDO 99-} РАДИАТОР ОХЛАЖДЕН						427 414 22



BORA 1,4i	1390AKQ	G	MA	9/98-
BORA 1,6i	1595AEH	G	MA	9/98-
GOLF IV 1,4	1398AHW/AKQ	G	MA	11/97-
OCTAVIA 1,6	1595AEH	G	MA	10/96-
TOLEDO II 1,6	1595AEH	G	M	9/98-

SEIBZ84-910	SE021117002A	64001	IBIZA '84-91 {MALAGA 85-} РАДИАТОР ОХЛАЖДЕН (NISSENS)						600 317 22
-------------	--------------	-------	---	--	--	--	--	--	------------

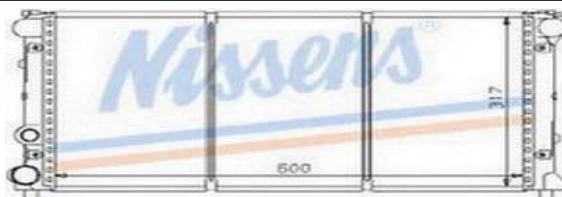



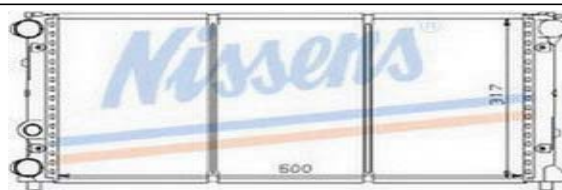

IBIZA 1,2L/GL/XL	1193S.PORSCHE	G	M	7/84-4/93
IBIZA 1,5S/GLX/SX	1461S.PORSCHE	G	M	7/84-4/93
MALAGA 1,2GL/GLX	1193S.PORSCHE	G	M	4/85-
MALAGA 1,5GL/GLX	1461S.PORSCHE	G	M	4/85-
RONDAP 1,2L/GL	1193S.PORSCHE	G	M	10/84-
RONDAP 1,5GL/GLX	1461S.PORSCHE	G	M	10/84-

SEIBZ84-911	SE021117002B/D	64002	IBIZA '84-91 {MALAGA 85-} РАДИАТОР ОХЛАЖДЕН (NISSENS)						600 317 38
-------------	----------------	-------	---	--	--	--	--	--	------------



IBIZA 1,5SXI	1461S.PORSCHE	G	M	*/-	3/88-4/93
IBIZA 1,7I/SXI	1675S.PORSCHE	G	M	*/-	11/91-4/93
IBIZA 1,7LD/XLD	1714FIAT	D	M		7/84-4/93
MALAGA 1,5I	1461S.PORSCHE	G	M	*/-	4/87-
MALAGA 1,7GLD/GLXD	1714FIAT	D	M		4/85-
RONDA 1,7GLD/GLXD	1714FIAT	D	M		2/86-

№ФОРВАРДА	№ OEM	№ NISSENS	МОДЕЛЬ	ТИП ДВИГАТЕЛЯ	БЕН/Д ИЗ	ТИП КП	КОНД ИЦИ	ГОД	ПРИМЕЧА НИЕ
SEIBZ84-912	SE021117002C	64003	IBIZA '84-93 РАДИАТОР ОХЛАЖДЕН (NISSENS)						344 322 34
			IBIZA I/S	903FIAT	G	M		7/84-4/93	
									
SEIBZ93-910	6N0121253A/B	63988A	IBIZA '93-99 {CORDOVA/POLO CLASSIC/CADDY} РАДИАТОР ОХЛАЖДЕН (DELPHI)						430 322 22
			CADDY II 1,9SDI	1896AEY	D	M		10/95-	
			IBIZA II 1,0CL	1043AAU	G	M		3/93-9/96	
			IBIZA II 1,3CL/CLX/GLX	1272AAV	G	M		3/93-8/99	
			INCA 1,9SDI	1896AEY	D	M		10/95-	
			POLO CLASSIC 1,9SDI	1896AEY	D	M		3/96-	
									
SETOL91-910	1L0121253A/C/F	63989	TOLEDO '91-99 РАДИАТОР ОХЛАЖДЕН (NISSENS)						675 322 0
			TOLEDO 1,6 100HP	1595	G	M	*/-	8/97-	
			TOLEDO 1,6CL/GL	1595 1F	G	M	*	5/91-	
			TOLEDO 1,8I/16V	1781RP/KR/PL/ADZ	G	M	*	5/91-	
			TOLEDO 1,9D CL/GL	1896 1Y/AAZ	D	M	*	5/91-	
			TOLEDO 1,9TDI	1896VW	D	MA	*	10/94-	
			TOLEDO 2,0I/16V	1984	G	M	*	5/91-	
									
SETOL91-911	1L0121253/E/J	64004A	TOLEDO '91-99 РАДИАТОР ОХЛАЖДЕН (NISSENS)						677 299 32
			TOLEDO 1,9 TURBO D	1896	D	M		5/91-	
			TOLEDO 1,9D CL/GL	1896	D	M		5/91-	
			TOLEDO 2,0I/16V	1984	G	A		5/91-	
									

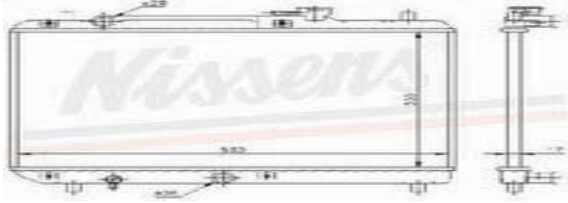
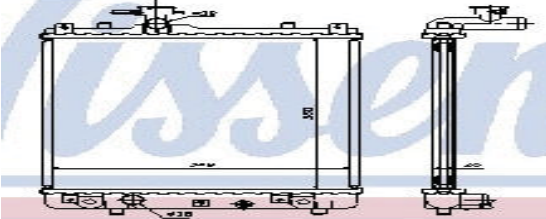
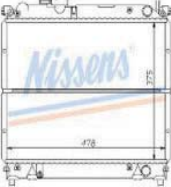
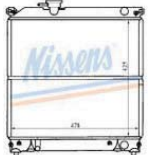
№ФОРВАРДА	№ OEM	№ NISSENS	МОДЕЛЬ	ТИП ДВИГАТЕЛЯ	БЕН/Д ИЗ	ТИП КП	КОНД ИЦИ	ГОД	ПРИМЕЧА НИЕ
SZBAL95-910	1770060G00	64177	BALENO '95-03 РАДИАТОР ОХЛАЖДЕН МТ 1.3 1.6 (NISSENS)						350 550 17
			BALENO 1,3i	1298G13BB	G	M	*/-	3/95-	
			BALENO 1,5i	1498 G15B	G	M	*/-		
			BALENO 1,6i	1590G16B	G	M	*/-	3/95-	
			BALENO 1,8i	1839 J18A	G	M	*/-		
									
SZIGS03-910	1300220/1770083E00	63014	IGNIS '03- {+ WAGON R+00-/OP AGILA 00- / SB JUSTY 03-} РАДИАТОР ОХЛАЖДЕН						380 378 27
			AGILA (00-) 1.0 i 12V	Z10XE/Z10XEP	G	M	+/-	03/00 -	
			AGILA (00-) 1.2 i 16V	Z12XE/Z12XEP	G	M	+/-	03/00 -	
			JUSTY (03-) 1.3 i 16V	M13A	G	M	+/-	09/03 -	
			JUSTY (03-) 1.5 i 16V	M15A	G	M	+/-	09/03 -	
			IGNIS (03-) 1.3 i 16V	M13A	G	M	+/-	08/03 -	
			IGNIS (03-) 1.5 i 16V	M15A	G	M	+/-	08/03 -	
			WAGON R+ (00-) 1.0 i	G10A	G	M	+/-	02/00 -	
			WAGON R+ (00-) 1.3 i 16V	G13BB	G	M	+/-	02/00 -	
									
SZVIT88-910	1770060A00/A00/A11	64079	VITARA '88- РАДИАТОР ОХЛАЖДЕН (NISSENS)						375 478 36
			VITARA 1,6 I16v	G16B	G	M	*/-	6/91-	
			VITARA 2,0 td 16v	RF	D	M	*/-	6/91-	
			VITARA TA01 JX/JLX	G16A	G	M	*/-	9/88-	
			VITARA TD01 JLX	G16B	G	M	*/-	6/91-	
									
SZVIT91-910	1770056B10	64181	VITARA '91-97 {JLX} РАДИАТОР ОХЛАЖДЕН МТ 1.6 (NISSENS)						425 478 36
			VITARA 2,0 td 16v	RF	D	M	*/-	9/2-	
			VITARA TD01 JLX/INJ	G16B	G	M	*/-	06/91-	
									

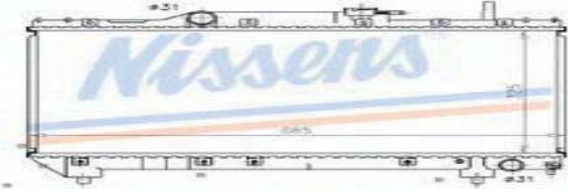
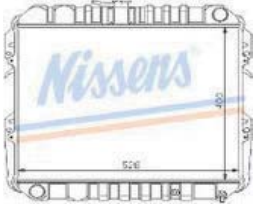
№ ФОРВАРДА	№ OEM	№ NISSENS	МОДЕЛЬ	ТИП ДВИГАТЕЛЯ	БЕН/Д ИЗ	ТИП КП	КОНД ИЦИ	ГОД	ПРИМЕЧА НИЕ
SZVIT94-910	1770086CA1	64178	VITARA '94-97 РАДИАТОР ОХЛАЖДЕН МТ (NISSENS)						375 475 36
			VITARA 1,9D VITARA 2,0 TD 8V	XUD9 RF	D D	M M	*/-	95/9-96/12 96/2	
TYAVE97-913	1640003180	64783A	AVENSIS '97-02 РАДИАТОР ОХЛАЖДЕН МТ 2 (NISSENS)						325 685 17
			AVENSIS ST220	2,0 3SFE	G	M		10/97-	
TYHIX83-910	1640035350/71080/71070/35210/71081/04020	64728	HILUX '83-88 РАДИАТОР ОХЛАЖДЕН (NISSENS)						400 526 33
			HILUX RN106-2400 HILUX RN110-2400 HILUX RN57/60-2000 HILUX YN106-2200 HILUX YN110-2200 HILUX YN56-1800 HILUX YN65-2000 HILUX YN67-2000 HILUX YN67-2200 HILUX YN85-1800 HILUX YN90-1800 PICK-UP LNS6 PICK-UP RN50 PICK-UP RN55	22374Y 22374Y 3Y 22374Y 22374Y 2Y 3Y 3Y 4Y 2Y 2Y 2,4 2,4 2,4	G G G G G G G G G G G G G G	M M M M M M M M M M M M M M	8/88- 8/88- 8/83-8/88 8/88- 8/88- 8/83-8/88 8/83-8/88 8/88- 8/83-8/88 8/88- 8/88- /84- /84- /84-		

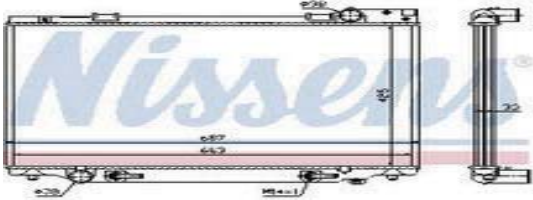
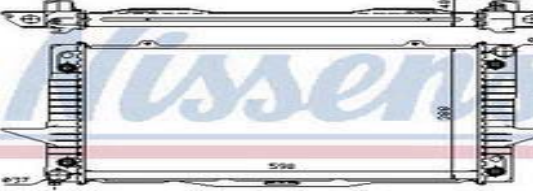
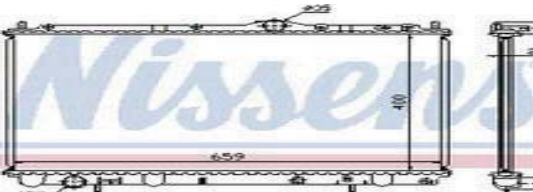
№ФОРВАРДА	№ OEM	№ NISSENS	МОДЕЛЬ	ТИП ДВИГАТЕЛЯ	БЕН/Д ИЗ	ТИП КП	КОНД ИЦИ	ГОД	ПРИМЕЧА НИЕ
TYPRV90-910	1640064680/1640076061/1640076071/1640076081/1640076072	64745	PREVIA '90-00РАДИАТОР ОХЛАЖДЕНИЯ (NISSENS)						425 687 33
			PREVIA 2,4i PREVIA 2,4i	2TZ-FE 2TZ-FE	G G	M/A M/A	*/- */-	90/05-93/8 93/8-99/12	
VV85093-910	8601356/8602562/6842768/8601001/86013568602562	65539A	850 '93-98 {+ S70/V70 97-99} РАДИАТОР ОХЛАЖДЕНИЯ (NISSENS)						590 388 40
			VOLVO 850 2,0 TURBO 20V VOLVO 850 2,3 TURBO 20V VOLVO 850 2,5 TURBO 20V VOLVO S70 2,0 T 20V VOLVO S70 2,3 20V TURBO VOLVO S70 2,5 20V TURBO	1984 B5204T 2319 B5234T 2435 B5254T 1948 B5202T 2319 B5234T3 2435 B5254T	G G G G G G	A A A A A A	*/- */- */- */- */- */-	93/9-96/12 93/9-96/12 93/9-96/12 96/12-98/12 96/12-98/12 96/12-98/12	
VV85093-911	6842767/8601000/8601355	65540A	850 '93-98 {+ S70/V70 97-99} РАДИАТОР ОХЛАЖДЕНИЯ (NISSENS)						640 415 32
			VOLVO 850 2,0 TURBO 20V VOLVO 850 2,3 TURBO 20V VOLVO 850 2,5 TURBO 20V VOLVO S70/V70 2,0 T 20V VOLVO S70/V70 2,3 20V TURBO VOLVO S70/V70 2,5 20V TURBO	1984 B5204T 2319 B5234T 2435 B5254T 1948 B5202T 2319 B5234T3 2435 B5254T	G G G G G G	M M M M M M	*/- */- */- */- */- */-	93/9-96/12 93/9-96/12 93/9-96/12 96/12-98/12 96/12-98/12 96/12-98/12	
VVS4093-910	8602065	65543A	S40 '93-98 {+V40} РАДИАТОР ОХЛАЖДЕНИЯ (NISSENS)						400 659 22
			VOLVO S40 1,6i VOLVO S40 1,6i VOLVO S40 1,8i VOLVO S40 1,8i VOLVO S40 2,0i VOLVO S40 2,0i	1598 B4164 S 1598 B4164 S 1731 B4184S 1731 B4184S 1998 B4204 S 1998 B4204 S	G G G G G G	M A M A M A	*/- */- */- */- */- */-	95/6-99/6 95/6-99/6 95/6-99/6 95/6-99/6 95/6-99/6 95/6-99/6	

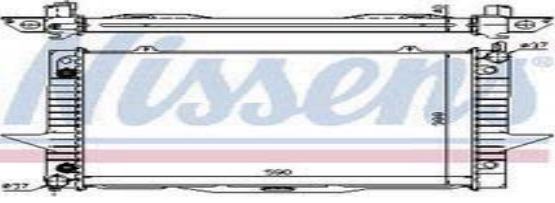
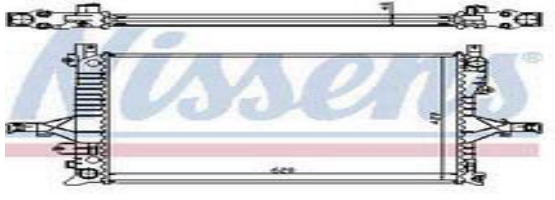
№ФОРВАРДА	№ OEM	№ NISSENS	МОДЕЛЬ	ТИП ДВИГАТЕЛЯ	БЕН/Д ИЗ	ТИП КП	КОНД ИЦИ	ГОД	ПРИМЕЧА НИЕ
VVS7099-910	8601450/8601451/8602558/8602559	65548A	S70 '99- {+V70/C 70/XC70} РАДИАТОР ОХЛАЖДЕНИЯ (NISSENS)						590 388 40
			VOLVO C70 2,0 T	1948 B5202T	G	A	*	99/1-00/1	
			VOLVO C70 2,3 T	2319 B5234T3	G	A	*	99/1-00/1	
			VOLVO C70 2,4 T	2435 B5244T3	G	A	*/-	99/1-00/1	
			VOLVO C70 2,4i	2435 B5244S	G	A	*	99/1-00/1	
			VOLVO S 70 2,5 TDi	2461 D5252T	D	A	*/-	99/1-00/1	
			VOLVO S70 2,0 10 V	1984 B5202S	G	A	*/-	99/1-00/1	
			VOLVO S70 2,0 T 20 V	1948 B5202T	G	A	*/-	99/1-00/1	
			VOLVO S70 2,3 20 V TURBO	2319 B5234T3	G	A	*/-	99/1-00/1	
			VOLVO S70 2,4T	2435 B5244T3	G	A	*/-	99/1-00/1	
			VOLVO S70 2,4T	2435 B5252	G	A	*/-	99/1-00/1	
			VOLVO S70 2,5 10 V	2435 B5252S	G	M/A	*/-	99/1-00/1	
			VOLVO S70 2,5 10 V	2435 B5252S	G	A	*/-	99/1-00/1	
			VOLVO S70 2,5 10 V	2435 B5252S	G	A	*/-	99/1-00/1	
			VOLVO S70 2,5 20 V TURBO	2435 B5254T	G	A	*/-	99/1-00/1	
			VOLVO XC 70 2,0 T	1948 B5202T	G	A	*/-	99/1-00/1	
			VOLVO XC 70 2,4 T	2435 B5244T3	G	A	*/-	99/1-00/1	
			VOLVO XC 70 2,5 T	2435 B5254T	G	A	*/-	99/1-00/1	
VVS8098-910	861432/8601563/8601585/8602412/8602413	65557A	S80 '98- {+(S70/V70/C70/XC70/S60 00-)} РАДИАТОР ОХЛАЖДЕНИЯ (NISSENS)						620 422 40
			VOLVO C70 2,0 T	1948 B5202T	G	M	*/-	00/2-	
			VOLVO C70 2,0 T	2319 B5234T3	G	M	*/-	00/2-	
			VOLVO C70 2,0 T	2435 B5244T3	G	M	*/-	00/2-	
			VOLVO S60 T5	2498 B5254T	G	M	*/-	00/9	
			VOLVO S60 2,0 T	1998 B5204T5	G	M	*/-	00/9	
			VOLVO S60 2,3 T	2332 B5244T3	G	M	*/-	00/9	
			VOLVO S60 2,4 D	2338 D5244T	G	M	*/-	00/9	
			VOLVO S60 2,4 i 10 V	2435 B5244S	G	M	*/-	00/9	
			VOLVO S60 2,4 i 20 V	2435 B5244S	G	M	*/-	00/9	
			VOLVO S60 2,4 T	2435 B5244T3	G	M	*/-	00/9	
			VOLVO S60 D5	2468 D5252T	D	M	*/-	00/9-	
			VOLVO S70 2,0 T	1998 B5205T4	G	M	*/-	00/2-	
			VOLVO S70 2,3 T	2332 B5234T	G	M	*/-	00/2-	
			VOLVO S70 2,4 T	2435 B5244T3	G	M	*/-	00/2-	
			VOLVO S70 2,4D	2338 D5244T	D	M	*/-	00/2-	
			VOLVO S70 2,4D	2468 D5252T	D	M	*/-	00/2-	
			VOLVO S70 2,4i 10V	2435 B5252	G	M	*/-	00/2-	
			VOLVO S70 2,4i 20V	2435 B5254S4	G	M	*/-	00/2-	
			VOLVO S80 2,0 T	1998 B5204T5	G	M	*/-	98/8-	
			VOLVO S80 2,3 T	2332 B5234T	G	M	*/-	98/8-	
			VOLVO S80 2,4 T	2435 B5244T3	G	M	*/-	98/8-	
			VOLVO S80 2,4i 20 V	2435 B5244S	G	M	*/-	98/8-	
			VOLVO S80 2,5 T	2498 B5254T	G	M	*/-	98/8-	
			VOLVO S80 2,5 TD	2338 D5244T	D	M	*/-	98/9-	
			VOLVO S80 2,9 24V T6	2898 B6294T	G	M	*/-	98/9-	
			VOLVO S80 2,9i 24V	2922 B6294S	G	M	*/-	98/8-	
			VOLVO S80 D5	2461 D5252T	D	M	*/-	98/9-	
		VOLVO XC 70 2,3 T	2332 B5234T	G	M	*/-	00/2-		
		VOLVO XC 70 2,4 D	2338 D5244T	G	M	*/-	00/2-		
		VOLVO XC 70 2,4 T	2435 B5244T3	G	M	*/-	00/2-		

№ ФОРВАРДА	№ OEM	№ NISSENS	МОДЕЛЬ	ТИП ДВИГАТЕЛЯ	БЕН/Д ИЗ	ТИП КП	КОНД ИЦИ	ГОД	ПРИМЕЧА НИЕ
VVS8098-911	8601433/8601564/8601586/8602414/8602755/8603294/8603294/8603	65553A	S80 '98- {(S70/V70/C70/XC70/S60 00-)} РАДИАТОР ОХЛАЖДЕНИЯ (NISSENS)						620 422 40
			VOLVO C70 2,0T	1948 B5202T	G	A	*/-	00/02-	
			VOLVO C70 2,3T	2319 B5234T3	G	A	*/-	00/02-	
			VOLVO C70 2,4T	2435 B5244T3	G	A	*/-	00/02-	
			VOLVO S60 2,0 T	1998 B5204T5	G	A	*/-	00/09-	
			VOLVO S60 2,3 T	2332 B5234T	G	A	*/-	00/09-	
			VOLVO S60 2,4 D	2338 D5244T	D	A	*/-	00/09-	
			VOLVO S60 2,4 T	2435 B5244T3	G	A	*/-	00/09-	
			VOLVO S60 2,4i 10V	2435 B5244S	G	A	*/-	00/09-	
			VOLVO S60 2,4i 20V	2435 B5244S	G	A	*/-	00/09-	
			VOLVO S60 5 D	2468 D5252T	D	A	*/-	00/09-	
			VOLVO S60 T5	2498 B5254T	G	A	*/-	00/09-	
			VOLVO S70/V70 2,0T	1998 B5205T4	G	A	*/-	00/02	
			VOLVO S70/V70 2,3T	2332 B5234T	G	A	*/-	00/02	
			VOLVO S70/V70 2,4 D	2338 D5244T	D	A	*/-	00/02	
			VOLVO S70/V70 2,4i 10V	2435 B5252	G	A	*/-	00/02	
			VOLVO S70/V70 2,4i 20V	2435 B5254S4	G	A	*/-	00/02	
			VOLVO S70/V70 2,4T	2435 B5244T3	G	A	*/-	00/02	
			VOLVO S70/V70 2,5 D	2468 D5252T	D	A	*/-	00/02	
			VOLVO S80 2,0 T	1998 B5204T5	G	A	*/-	98/08-	
			VOLVO S80 2,3 T	2332 B5234T	G	A	*/-	98/08-	
			VOLVO S80 2,4 T	2435 B5244T3	G	A	*/-	98/08-	
			VOLVO S80 2,4i 20 V	2435 B5244S	G	A	*/-	98/08-	
			VOLVO S80 2,5 T	2498 B5254T	G	A	*/-	98/08-	
			VOLVO S80 2,5 TD	2338 D5244T	D	A	*/-	98/09	
			VOLVO S80 2,8 T	2756 B6294T	G	A	*/-	98/08-	
			VOLVO S80 2,9 24V T6	2898 B6294T	G	A	*/-	98/09-	
			VOLVO S80 2,9i 24V	2922 B6294S	G	A	*/-	98/08-	
			VOLVO S80 D5	2461 D5252T	D	A	*/-	98/9-	
		VOLVO XC 70 2,4D	2338 D5244T	D	A	*/-	00/02		
		VOLVO XC 70 2,3 T	2332 B5234T	G	A	*/-	00/02		
		VOLVO XC 70 2,4T	2435 B5244T3	G	A	*/-	00/02		
VWCAD95-910	6K0121253H/S	63996A	CADDY '95- {INCA} РАДИАТОР ОХЛАЖДЕН (NISSENS)						525 322 22
VWPLC96-914	6K0121253H/S	63996	POLO CLASSIC '96- {CADDY/IBIZA/CORDOBA 93-99} РАДИАТОР ОХЛАЖДЕН						525 322 22
VWPLC96-914	6K0121253H/S	63996	POLO CLASSIC '96- {CADDY/IBIZA/CORDOBA 93-99} РАДИАТОР ОХЛАЖДЕН						525 322 22

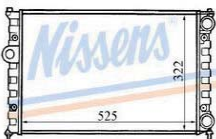

			CADDY II 1,6	1595 1F	G	M		10/95-	
			CORDOBA 1,8CLX/GLX	1781	G	M		12/93-	
			IBIZA II 1,8CLX/GLX	1781ABS/ADZ	G	M		3/93-8/99	
			INCA 1,6I	1595	G	M		4/95-	
			POLO CLASSIC 1,6	1598 1F	G	M		3/96-	

№ ФОРВАРДА	№ OEM	№ NISSENS	МОДЕЛЬ	ТИП ДВИГАТЕЛЯ	БЕН/Д ИЗ	ТИП КП	КОНД ИЦИ	ГОД	ПРИМЕЧА НИЕ
VWCAD95-911	6K0121253/K/P	63995A	CADDY '95- {INCA} РАДИАТОР ОХЛАЖДЕН (NISSENS)						527 299 22
VWCAD95-912	6K121253/P	63995	CADDY '95- {INCA} РАДИАТОР ОХЛАЖДЕН						527 299 22
			CADDY II 1,4 CORDOBA 1,4CL/CLX/GLX CORDOBA 1,6CLX/GLX IBIZA II 1,4CL/CLX/GLX	1391AEX 1391 1595 1391APQ/ABD/AEX/AKV	G G G G	M M M M		10/95- 12/93-6/99 12/93-5/97 9/93-8/99	
			IBIZA II 1,6CLX/GLX INCA 1,4I POLO CLASSIC 1,4	1595 1391 1398AEX	G G G	M M M		5/93-5/97 4/95- 3/96-	

№ ФОРВАРДА	№ OEM	№ NISSENS	МОДЕЛЬ	ТИП ДВИГАТЕЛЯ	БЕН/Д ИЗ	ТИП КП	КОНД ИЦИ	ГОД	ПРИМЕЧА НИЕ
VWCAD95-913	6K0121253G/N	65268	CADDY '95- {INCA} РАДИАТОР ОХЛАЖДЕН						630 299 26
			CADDY 1,9 D CORDOBA 1,6 i CORDOBA 1,8 i CORDOBA 1,8 i CORDOBA 1,8 i CORDOBA 1,9D CORDOBA 1,9D IBIZA 1,6i IBIZA 1,8i IBIZA 1,8i IBIZA 1,9 D INCA 1,9 D POLO CLASSIC 1,9 D	1896 1Y 1595 1F 1781 ABS 1781 ADZ 1781 ADZ 1896 1Y 1896 1Y 1595 1F 1781 ABS 1781 ADZ 1898 1Y 1896 1Y 1896 1Y	D G G G G D G G G G D D	M A A A M/A M M A A A A M M		95/10-03/6 96/7-99/6 93/2-94/8 94/9-96/6 96/7-99/6 93/2-96/6 96/7-99/6 96/7-99/6 93/2-94/8 94/9-99/6 93/2-99/6 95/11-03/6 96/5-96/10	

№ ФОРВАРДА	№ OEM	№ NISSENS	МОДЕЛЬ	ТИП ДВИГАТЕЛЯ	БЕН/Д ИЗ	ТИП КП	КОНД ИЦИ	ГОД	ПРИМЕЧА НИЕ
VWGLF84-910	321121253ALK/1L0121253B	651511	GOLF '84-91 {JETTA/SE TOLEDO 91-} РАДИАТОР ОХЛАЖДЕН (NISSENS)						525 320 22
VWGLF84-914	321121253ALK/1L0121253B	65151A	GOLF '84-91 {JETTA/SE TOLEDO 91-} РАДИАТОР ОХЛАЖДЕН						527 322 22
			GOLF 1600/LD/GLD GOLF 1600GLI/GTI GOLF 1800GLI/GTI GOLF II 1600D C/CL/GL GOLF II 1800GL/GT/GTI JETTA 1600D/LD/GLD JETTA 1600GLI JETTA 1800GLI JETTA II 1600D C/CL/GL JETTA II 1800GL/GT/GLI PASSAT II 1600D C/CL/GL SANTANA 1600D SCIROCCO II 1500CL/GL/GT SCIROCCO II 1600CL/GL/GT SCIROCCO II 1600GLI SCIROCCO II 1800GLI/GTI TOLEDO 1,6CL/GL	1588CR 1588EG 1781DX 1588JK/IP 1781GU/RH/RP/IP/GX 1588CR 1588EG 1781DX 1588JK/JP 1781GU/RH/RP/IP/GX 1588CR/JK 1588CR/JK 1457JB 1588FR/EW/RE 1588EG 1781DX/JH 1595	D G G D G D G D G D D G G G G G G G	M M M M MA M M M MA MA MA M M M M M M		9/81-2/84 9/81-8/82 9/82-2/84 9/83-8/91 9/83-8/91 9/81-2/84 9/81-8/82 9/81-8/82 9/82-2/84 3/84-12/91 3/84-12/91 8/82-8/83 8/82-8/83 3/83- 2/83- 8/81- 7/82- 5/91-	

№ ФОРВАРДА	№ OEM	№ NISSENS	МОДЕЛЬ	ТИП ДВИГАТЕЛЯ	БЕН/Д ИЗ	ТИП КП	КОНД ИЦИ	ГОД	ПРИМЕЧА НИЕ
VWGLF84-911	191121251C/F/B/J	652621	GOLF '84-92 {JETTA} РАДИАТОР ОХЛАЖДЕН (NISSENS)						675 320 32
VWGLF84-916	191121251C/F/253/B/J	65262A	GOLF '84-92 {JETTA} РАДИАТОР ОХЛАЖДЕН						677 299 32
			GOLF II 1600 TURBO D JETTA II 1600C/CL/GL JETTA II 1800GL/GT/GLI JETTA II 1800GTX 16V	1588JR/RA/SB 1595EZ/RF/PN 1781GU/RH/RP/IP/GX 1781KR/PL	D G G G	M MA MA M		9/83-8/91 3/84- 3/84- 3/84-	



№ ФОРВАРДА	№ OEM	№ NISSENS	МОДЕЛЬ	ТИП ДВИГАТЕЛЯ	БЕН/Д ИЗ	ТИП КП	КОНД ИЦИ	ГОД	ПРИМЕЧА НИЕ
VWGLF91-911	1H0121253D/H/Q	65193A	GOLF '92-96 {VENTO} РАДИАТОР ОХЛАЖДЕН						628 322 22
			GOLF III 1,8	1781AAM/ABS	G	A	9/91-		
			GOLF III 1,9SDI	1896AEY	D	M	3/95-		
			GOLF III 2,0/2,0 16V	1984 2E/ABF/AGG	G	M	9/91-		
			GOLF III 2,0/2,0 16V	1984 2E/ABF	G	A	10/91-		
			GOLF III TDI 90HP	1896 1Z/AHU	D	M	1/94-		
			VENTO 1,8	1781AAM/ABS	G	A	1/92-		
			VENTO 1,9SDI	1896AEY	D	M	3/95-		
			VENTO 1,9TDI 90HP	1896 1Z/AHU	D	M	1/94-		
			VENTO 2,0/2,0 16V	1984 2E/ABF	G	A	1/92-		
			VENTO 2,0/2,0 16V	1984 2E/ABF/AGG	G	M	1/92-		
VWGLF92-910	6N0121253A/B	65185A	GOLF '92-97 {VENTO} РАДИАТОР ОХЛАЖДЕН 1.4 MT (NISSENS)					433 299 22	
VWGLF92-915	6N0121253A/B	65185A	GOLF '92-97 {VENTO} РАДИАТОР ОХЛАЖДЕН 1.4 MT					433 299 22	
			GOLF III 1,4	1398ABD/AEX	G	M	9/91-		
			GOLF III 1,4	1398 AEX	G	M	95/7-97/12		
			GOLF III 1,4	1595 ABU	G	M	94/10-95/7		
			GOLF III 1,6 i	1595 AEA	G	M	94/10-95/7		
			GOLF III 1,6 i	1595 AEE	G	M	95/7-97/12		
			JETTA 1,4i	1398 ABD	G	M	1/92-		
			JETTA 1,4i	1398 AEX	G	M	95/7-97/12		
			JETTA 1,4i	1595 ABU	G	M	94/10-95/7		
			JETTA 1,6i	1595 AEA	G	M	94/10-95/7		
			JETTA 1,6i	1595 AEE	G	M	95/7-97/12		
			VENTO 1,4	1398ABD/AEX	G	M	91/11-95/7		
			VENTO 1,4	1398 AEX	G	M	92/8-94/9		
			VENTO 1,6i	1595 AEA	G	M	94/10-95/7		
			VENTO 1,6i	1595 AEE	G	M	95/7-97/12		
VWGLF92-911	1H0121253BE/BJ	65248A	GOLF '92-96 {VENTO} РАДИАТОР ОХЛАЖДЕН (NISSENS)					625 379 32	
VWGLF92-919		65248	GOLF '92-96 {VENTO} РАДИАТОР ОХЛАЖДЕН					625 379 32	
			AROSA 1,0	990AER	G	M	*	7/97-	
			AROSA 1,4	1390AEX	G	M	*	7/97-	
			AROSA 1,4	1390AEX	G	A	—	7/97-	
			AROSA 1,4	1390AEX	G	A	*	1/97-	
			GOLF III 2,8 VR6	2792AAA	G	M	*/-	9/91-	
			VENTO 2,8 VR6	2792AAA	G	MA	*/-	1/92-	
VWGLF92-916	6N0121253J	65187A	GOLF '92-97 {VENTO} РАДИАТОР ОХЛАЖДЕН 1.4 MT					525 322 22	
			GOLF III 1,6	1595 ABU/AEK/AFT/AEE	G	M		9/91-	
			VENTO 1,6	1595 ABU/AEE/AEA/AFT	G	M		1/92-	
			VENTO 2,0/2,0 16V	1984 2E/ABF	G	MA	*	1/92-	

№ ФОРВАРДА	№ OEM	№ NISSENS	МОДЕЛЬ	ТИП ДВИГАТЕЛЯ	БЕН/Д ИЗ	ТИП КП	КОНД ИЦИ	ГОД	ПРИМЕЧА НИЕ
VWGLF92-918	1H0121253BA/BD/BK/BM	65247	GOLF 92-96 {VENTO} РАДИАТОР ОХЛАЖДЕН						628 377 34
				GOLF CABRIO 1.6 i	AKS	G	M/A	+	06/98 -
				GOLF CABRIO 1.8 i	AAM	G	A	+/-	06/98 -
				GOLF CABRIO 1.8 i	ADZ	G	M/A	+	06/98 -
				GOLF CABRIO 2.0 i	AGG/AKR	G	M	+	06/98 -
				GOLF CABRIO 1.9 TDi	AHU	D	M/A	+	06/98 -
				GOLF CABRIO 1.9 TDi	ALE	D	M	+	06/98 -
				GOLF III 1.6 i	AEK	G	M/A	+	10/94 - 12/95
				GOLF III 1.6 i	AFT/AKS	G	M/A	+	07/95 - 12/97
				GOLF III 1.8 i	AAM	G	M	+	11/91 - 12/97
				GOLF III 1.8 i	AAM	G	A	+/-	11/91 - 12/97
				GOLF III 1.8 i	ABS	G	M/A	+	11/91 - 09/94
				GOLF III 1.8 i	ACC	G	M	+	04/95 - 12/97
				GOLF III 1.8 i	ADZ	G	M/A	+	10/94 - 12/97
				GOLF III 2.0 i	ABF	G	M	+	08/92 - 12/97
				GOLF III 2.0 i	ADY	G	M/A	+	10/94 - 05/96
				GOLF III 2.0 i	AEP	G	M/A	+	01/95 - 12/97
				GOLF III 2.0 i	AGG	G	M	+	07/95 - 12/97
				GOLF III 2.0 i	AKR	G	M	+	05/97 - 12/97
				GOLF III 2.0 i	2E	G	M/A	+	11/91 - 09/94
				GOLF III 1.9 TDi	AHU	D	M/A	+	08/96 - 12/97
				GOLF III 1.9 TDi	ALE/ALE/AAZ	D	M	+	05/97 - 12/97
				GOLF III 1.9 TDi	IZ	D	M/A	+	08/93 - 07/96
				JETTA 1.6 i	AEK	G	M/A	+	10/94 - 12/95
				JETTA 1.6 i	AFT/AKS	G	M/A	+	07/95 - 12/97
				JETTA 1.8 i	AAM	G	M	+	11/91 - 12/97
				JETTA 1.8 i	AAM	G	A	+/-	11/91 - 12/97
				JETTA 1.8 i	ABS	G	M/A	+	11/91 - 09/94
				JETTA 1.8 i	ACC	G	M	+	04/95 - 12/97
				JETTA 1.8 i	ADZ	G	M/A	+	10/94 - 12/97
				JETTA 2.0 i	ABF	G	M	+	08/92 - 12/97
JETTA 2.0 i	ADY	G	M/A	+	10/94 - 05/96				
JETTA 2.0 i	AEP	G	M/A	+	01/95 - 12/97				
JETTA 2.0 i	AGG	G	M	+	07/95 - 12/97				
JETTA 2.0 i	AKR	G	M	+	05/97 - 12/97				
JETTA 2.0 i	2E	G	M/A	+	11/91 - 09/94				
JETTA 1.9 TDi	AHU	D	M/A	+	08/96 - 12/97				
JETTA 1.9 TDi	ALE/AAZ	D	M	+	05/97 - 12/97				
JETTA 1.9 TDi	IZ	D	M/A	+	08/93 - 07/96				
VENTO 1.6 i	AEK	G	M/A	+	10/94 - 12/95				
VENTO 1.6 i	AFT/AKS	G	M/A	+	07/95 - 12/97				
VENTO 1.8 i	AAM	G	M	+	11/91 - 12/97				
VENTO 1.8 i	AAM	G	A	+/-	11/91 - 12/97				
VENTO 1.8 i	ABS	G	M/A	+	11/91 - 09/94				
VENTO 1.8 i	ACC	G	M	+	04/95 - 12/97				
VENTO 1.8 i	ADZ	G	M/A	+	10/94 - 12/97				

№ФОРВАРДА	№ OEM	№ NISSENS	МОДЕЛЬ	ТИП ДВИГАТЕЛЯ	БЕН/Д ИЗ	ТИП КП	КОНД ИЦИ	ГОД	ПРИМЕЧА НИЕ
			VENTO 2.0 i	ABF	G	M	+	08/92 - 12/97	
			VENTO 2.0 i	ADY	G	M/A	+	10/94 - 05/96	
			VENTO 2.0 i	AGG	G	M	+	07/95 - 12/97	
			VENTO 2.0 i	AKR	G	M	+	05/97 - 12/97	
			VENTO 2.0 i	2E	G	M/A	+	11/91 - 09/94	
			VENTO 1.9 TDi	AHU	D	M/A	+	08/96 - 12/97	
			VENTO 1.9 TDi	ALE/ALE	D	M	+	05/97 - 12/97	
			VENTO 1.9 TDi	1Z	D	M/A	+	08/93 - 07/96	
VWGLF97-910	1JO121253H/N/Q/G/J/S/K	652011	GOLF '97- {BORA/OCTAVIA 96-/TOLEDO 98-/A3 96-/TT 98} РАДИАТОР ОХЛАЖДЕН (NISSENS)						647 415 22
VWGLF97-911		65201	GOLF '97- {BORA/OCTAVIA 96-/TOLEDO 98-/A3 96-/TT 98} РАДИАТОР ОХЛАЖДЕН						647 397 24
			A 3 / S 3 (96-) 1.6 i	AEH/BFQ/APF/AVU/AKL	G	M/A	+/-	09/96 -	
			A 3 / S 3 (96-) 1.8 i 20V	AGN/APG	G	M/A	+/-	09/96 -	
			A 3 / S 3 (96-) 1.8 i TURBO 20V	AGU	G	M	-	09/96 -	
			A 3 / S 3 (96-) 1.8 i TURBO 20V	AGU	G	M	+	09/96 -	
			A 3 / S 3 (96-) 1.8 i TURBO 20V	AGU	G	A	+/-	09/96 -	
			A 3 / S 3 (96-) 1.8 i TURBO 20V	AMK/AQA/ARX/ARY/AUL/A	G	M/A	+/-	09/96 -	
			A 3 / S 3 (96-) 1.9 Tdi	AGR/AXR/ATD/ASZ/ALH/AF	D	M/A	+/-	09/96 -	
			TT (98-) 1.8 i 20V TURBO	AJQ/BFV/BAM/AUQ/AUM/AI	G	M/A	+/-	10/98 -	
			LEON (99-) 1.4 i 16V	AHW/BCA/AXP/APE	G	M	+	01/00 -	
			LEON (99-) 1.6 i	AEH/BFQ	G	M/A	+/-	11/98 -	
			LEON (99-) 1.6 i	AKL	G	M	+	10/98 -	
			LEON (99-) 1.6 i	AKL	G	M	-	10/98 -	
			LEON (99-) 1.6 i 16V	AUS/AZD/BCB/BFQ	G	M	+	06/00 -	
			LEON (99-) 1.6 i 16V	AUS/AZD/BCB/BFQ	G	M	-	06/00 -	
			LEON (99-) 1.8 i 20V	AGN	G	M	-	10/98 -	
			LEON (99-) 1.8 i 20V	AGN	G	M/A	+/-	10/98 -	
			LEON (99-) 1.8 i 20V	APG	G	M	-	06/00 -	
			LEON (99-) 1.8 i 20V	APG	G	M/A	+/-	06/00 -	
			LEON (99-) 1.8 i Turbo 20V	AJQ/AUQ/ARY/APP	G	M	+/-	03/00 -	
			LEON (99-) 1.9 Sdi	AQM	D	M	+/-	06/00 -	
			LEON (99-) 1.9 Sdi	AQM	D	M	-	06/00 -	
			LEON (99-) 1.9 Tdi	AGR/AHF/ALH/ASV	D	M	-	04/99 -	
			LEON (99-) 1.9 Tdi	AGR/AHF/ALH/ASV	D	M	+/-	04/99 -	
			LEON (99-) 1.9 Tdi	ASZ	D	M	+	05/03 -	
			TOLEDO (98-) 1.4 i 16V	AHW/BCA/AXP/APE	G	M	+	01/00 -	
			TOLEDO (98-) 1.6 i	AEH/BCB	G	M	-	11/98 -	
			TOLEDO (98-) 1.6 i	AEH/BCB	G	M	+	11/98 -	
			TOLEDO (98-) 1.6 i	AKL/BFQ	G	M	+/-	10/98 -	
			TOLEDO (98-) 1.6 i 16V	AUS/BFQ/BCA/AZD	G	M	+/-	06/00 -	
			TOLEDO (98-) 1.8 i 20V	AGN/APG	G	M/A	+/-	10/98 -	
			TOLEDO (98-) 1.8 i 20V	AGN/APG	G	M/A	+/-	10/98 -	
			TOLEDO (98-) 1.8 i 20V TURBO	AJQ/AUQ/ARY/APP	G	M	+/-	03/00 -	
			TOLEDO (98-) 1.9 Sdi	AQM	D	M	+/-	06/00 -	
			TOLEDO (98-) 1.9 Tdi	AGR/ASZ/ASV/ALH/AHF	D	M	+/-	04/99 -	
			OCTAVIA (96-) 1.4 i	AMD/BCA/AXP	G	M	+	02/99 -	
			OCTAVIA (96-) 1.6 i	AEE/AEH/AKL/AVU	G	M	+	10/96 -	
			OCTAVIA (96-) 1.6 i	AEH/AKL	G	M	-	12/97 -	
			OCTAVIA (96-) 1.6 i 16V	AVU/BFQ	G	M	-	10/96 -	
			OCTAVIA (96-) 1.6 i 16V	AVU/BFQ	G	M	+	10/96 -	
			OCTAVIA (96-) 1.8 i 20V	AGN	G	M	-	10/96 -	
			OCTAVIA (96-) 1.8 i 20V	AGN	G	M	+	10/96 -	
			OCTAVIA (96-) 1.8 i 20V TURBO	AGU/AUQ/AUM/ARZ/ARX	G	M/A	+/-	04/99 -	

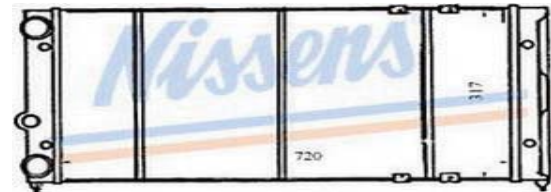

№ФОРВАРДА	№ OEM	№ NISSENS	МОДЕЛЬ	ТИП ДВИГАТЕЛЯ	БЕН/Д ИЗ	ТИП КП	КОНД ИЦИ	ГОД	ПРИМЕЧА НИЕ
			OCTAVIA (96-) 1.9 Sdi	AGP/AQM	D	M	-	10/96 -	
			OCTAVIA (96-) 1.9 Sdi	AGP/AQM	D	M	+	07/98 -	
			OCTAVIA (96-) 1.9 Tdi	AGR/AHF	D	M/A	+	10/96 -	
			OCTAVIA (96-) 1.9 Tdi	AGR/AHF	D	M	-	10/96 -	
			OCTAVIA (96-) 1.9 Tdi	ALH/ATD/ASZ/ASV	D	M/A	+/-	10/96 -	
			OCTAVIA (96-) 2.0 i	AEG/AZJ/AZH/AQY/APK	G	M/A	+	08/00 -	
			OCTAVIA (96-) 2.0 i	AEG/AZJ/AZH/AQY/APK	G	M/A	-	08/00 -	
			BORA (99-) 1.4 i 16V	AHW/AXP/APE/BCA/AKQ	G	M	+	05/00 -	
			BORA (99-) 1.6 i	AEH/AKL	G	M	-	05/00 -	
			BORA (99-) 1.6 i	AEH	G	A	+	09/98 -	
			BORA (99-) 1.6 i	AEH	G	A	-	09/98 -	
			BORA (99-) 1.6 i	AEH/AKL/PPF/ATN	G	M	+	05/00 -	
			BORA (99-) 1.6 i	AKL/PPF/AVU	G	A	+/-	09/98 -	
			BORA (99-) 1.6 FSI	BAD	G	M	+/-	05/02 -	
			BORA (99-) 1.6 i	BFQ	G	M	+/-	09/00 -	
			BORA (99-) 1.6 i 16V	AZD/AUS/BCB	G	M	+/-	09/00 -	
			BORA (99-) 1.8 i 20V	AGN	G	M	+/-	02/99 -	
			BORA (99-) 1.8 i 20V	AGN	G	A	+/-	02/99 -	
			BORA (99-) 1.8 i 20V TURBO	AGU/AUQ/ARX/AUM	G	A	+/-	05/00 -	
			BORA (99-) 1.8 i 20V TURBO	AGU/AUQ/AUM	G	M	+/-	09/00 -	
			BORA (99-) 2.0 i	APK/AQY/AZH	G	M	+	11/98 -	
			BORA (99-) 2.0 i	APK/AQY/AZH	G	A	+	11/98 -	
			BORA (99-) 2.0 i	APK/AQY/AZH	G	M	-	11/98 -	
			BORA (99-) 2.0 i	APK/AQY/AZH	G	A	-	11/98 -	
			BORA (99-) 2.0 i	AVH/AZG	G	A	+/-	02/01 -	
			BORA (99-) 1.9 Sdi	AGP/AQM	D	M	-	05/00 -	
			BORA (99-) 1.9 Sdi	AGP/AQM	D	M	+	05/00 -	
			BORA (99-) 1.9 Tdi	AGR/AHF/AXR/AJM/ALH/AT	D	M	-	10/98 -	
			BORA (99-) 1.9 Tdi	AGR/AHF/AXR/AJM/ALH/AT	D	M	+	10/98 -	
			BORA (99-) 1.9 Tdi	AGR/AHF/AJM/ALH/ATD/AU	D	A	+/-	10/98 -	
			BORA (99-) 1.9 Tdi	ASV/ASZ	D	M	+/-	05/00 -	
			GOLF IV (97-) 1.4 i 16V	AHW/AKQ/APE/AXP/BCA	G	M	+	10/97 -	
			GOLF IV (97-) 1.6 i	AEH/AKL/PPF/ATN/AVU	G	M/A	-	01/98 -	
			GOLF IV (97-) 1.6 i	AEH/AKL/PPF/ATN/AVU/BF	G	M/A	+	01/98 -	
			GOLF IV (97-) 1.6 i 16V	AUS/AZD/BCB	G	M	-	05/00 -	
			GOLF IV (97-) 1.6 i 16V	AUS/AZD/BCB	G	M	+	05/00 -	
			GOLF IV (97-) 1.6 i	BFQ	G	M	-	05/02 -	
			GOLF IV (97-) 1.6 FSI	BAD	G	M	-	08/01 -	
			GOLF IV (97-) 1.6 FSI	BAD	G	M	+	08/01 -	
			GOLF IV (97-) 1.8 i 20V	AGN	G	M/A	-	10/97 -	
			GOLF IV (97-) 1.8 i 20V	AGN	G	M/A	+/-	10/97 -	
			GOLF IV (97-) 1.8 i 20V TURBO	AGU/AUM	G	M/A	+/-	10/97 -	
			GOLF IV (97-) 1.8 i 20V TURBO	ARZ/AUQ	G	M	+/-	05/99 -	
			GOLF IV (97-) 2.0 i	APK/AQY/AZH/AZJ/BEH	G	M/A	-	08/98 -	
			GOLF IV (97-) 2.0 i	APK/AQY/AZH/AZJ/BEH	G	M/A	+	08/98 -	
			GOLF IV (97-) 2.0 i	AZG	G	M/A	+/-	05/01 -	
			GOLF IV (97-) 2.3 i V5	AGZ	G	M/A	+/-	10/97 -	
			GOLF IV (97-) 1.9 Sdi	AGP/AQM	D	M	+	10/97 -	
			GOLF IV (97-) 1.9 Sdi	AGP/AQM	D	M	-	10/97 -	
			GOLF IV (97-) 1.9 Tdi	AGR/AHF/ALH/ASV/ASZ/AT	D	M/A	-	10/97 -	
			GOLF IV (97-) 1.9 Tdi	AGR/AHF/ALH/ASV/ATD/AU	D	M/A	+	10/97 -	
			GOLF IV (97-) 1.9 Tdi	AJM/AUY/AXR	D	M	-	05/99 -	
			GOLF IV (97-) 1.9 Tdi	AJM/AXR	D	M	+	05/99 -	

№ФОРВАРДА	№ OEM	№ NISSENS	МОДЕЛЬ	ТИП ДВИГАТЕЛЯ	БЕН/Д ИЗ	ТИП КП	КОНД ИЦИ	ГОД	ПРИМЕЧА НИЕ
VWPAS88-911	353121253AD/G/J	651621	PASSAT '88-93 РАДИАТОР ОХЛАЖДЕН (NISSENS)						724 322 33
VWPAS88-918	353121253AD/G/J	65162	PASSAT '88-93 РАДИАТОР ОХЛАЖДЕН						724 322 33
				1595EZ/RF/1F	G	MA	*	4/88-10/93	
				1781AAM/PB/PF/RF/KR	G	MA	*	4/88-10/93	
				1984AAW/2E/9A	G	MA	*	4/88-2/91	
VWPAS88-912	353121253R	65237	PASSAT '88-93 РАДИАТОР ОХЛАЖДЕН (NISSENS)						720 317 33
				1588RA	D	M	*	4/88-7/89	
				1588SB	D	M	*	8/89-10/93	
				1896 1Y	D	MA	*	5/89-7/92	
				2792AAA	G	M	*	6/91-10/91	
				1781PG	G	M	*	9/89-10/93	
VWPAS88-913	353121253AC	65174A	PASSAT '88-93 РАДИАТОР ОХЛАЖДЕН (NISSENS)						527 322 22
VWPAS88-910	353121253AC	65174	PASSAT '88-93 РАДИАТОР ОХЛАЖДЕН (Китай)						527 322 22
				1595 ABN	G	M		91/10-92/7	
				1595 EZ	G	M		88/4-91/9	
				1595 EZ	G	A		88/4-91/7	
				1595 RF	G	M/A		88/4-89/7	
				1595 1F	G	M/A		88/8-90/7	
				1781 AAM	G	M		90/8-93/10	
				1781 ABS	G	M		91/8-93/10	
				1781 ABS	G	A		91/8-93/10	
				1781 PB	G	M/A		88/4-90/7	
				1781 PF	G	M		88/4-90/7	
				1781 PF	G	A		88/4-90/7	
				1781 PR	G	M		88/4-91/7	
				1781 PR	G	A		88/4/91/7	
VWPAS88-914	353121253T/AA	65165A	PASSAT '88-93 РАДИАТОР ОХЛАЖДЕН (NISSENS)						433 299 22
VWPAS88-917	353121253T/AA	65165A	PASSAT '88-93 РАДИАТОР ОХЛАЖДЕН						432 299 22
				1595 ABN	G	M		91/10-92/7	
				1595 EZ	G	M		88/4-91/9	
				1595 EZ	G	A		88/4-91/7	
				1595 RF	G	M/A		88/4-89/7	
				1595 1F	G	M/A		88/8-90/7	
				1781 AMM	G	M		90/8-93/10	

№ФОРВАРДА	№ OEM	№ NISSENS	МОДЕЛЬ	ТИП ДВИГАТЕЛЯ	БЕН/Д ИЗ	ТИП КП	КОНД ИЦИ	ГОД	ПРИМЕЧА НИЕ
VWPAS88-915	353121253F/E	65161/65159	PASSAT '88-93 РАДИАТОР ОХЛАЖДЕН						634 322 33
VWPAS88-916	353121253E/F	65161	PASSAT '88-93 РАДИАТОР ОХЛАЖДЕН (NISSENS)						634 322 33
				PASSAT III 1600 TURBO D	1588 RA	D	M	4/88-7/89	
				PASSAT III 1600 TURBO D	1588 SB	D	M	4/89-10/93	
				PASSAT III 1800 16V	1781 KR	G	MA	4/88-10/93	HD
				PASSAT III 1800 CL/GL/GT	1781 AAM/PB/PF/RP	G	MA	4/88-7/90	HDTRONIC
				PASSAT III 1900D	1898 1Y	D	MA	4/88-10/93	HD
				PASSAT III 2000GL/GLS/GT/16V	1984 AAW/2E/9A	G	MA	4/88-10/93	HD

№ФОРВАРДА	№ OEM	№ NISSENS	МОДЕЛЬ	ТИП ДВИГАТЕЛЯ	БЕН/Д ИЗ	ТИП КП	КОНД ИЦИ	ГОД	ПРИМЕЧА НИЕ
VWPAS91-10	1H0121253AE	65243A	PASSAT '91-93 РАДИАТОР ОХЛАЖДЕН (NISSENS)						625 379 32
				GOLF III 1,9 D	1896 1Y	D	M	91/11-97/12	
				GOLF III 1,9 D	1896 AAZ	D	M	*-/ 91/11-97/12	
				GOLF III 1,9 D	1896 AAZ	D	A	*-/ 91/11-94/7	
				GOLF III 1,9 TDi	1896 AFN	D	M/A	*-/ 91/11-97/12	
				JETTA 1,9 D	1896 1Y	D	M	91/11-97/12	
				JETTA 1,9 D	1896 AAZ	D	M	*-/ 91/11-97/12	
				JETTA 1,9 D	1896 AAZ	D	A	*-/ 91/11-94/7	
				JETTA 1,9 Tdi	1896 AFN	D	M/A	*-/ 96/2-97/12	
				PASSAT 1,9 D	1896 1Y	D	M	89/5-93/10	
				PASSAT 1,9 TD	1896 AAZ	D	M/A	91/3-93/10	
				VENTO 1,9 D	1896 1Y	D	M	91/11-97/12	
				VENTO 1,9 D	1896 AAZ	D	M	*-/ 91/11-97/12	
				VENTO 1,9 D	1896 AAZ	D	A	*-/ 91/11-94/7	
				VENTO 1,9 Tdi	1896 AFN	D	M/A	*-/ 96/2-97/12	

№ФОРВАРДА	№ OEM	№ NISSENS	МОДЕЛЬ	ТИП ДВИГАТЕЛЯ	БЕН/Д ИЗ	ТИП КП	КОНД ИЦИ	ГОД	ПРИМЕЧА НИЕ
VWPAS91-911	6K0121253AA/1H0121253L	65245A	PASSAT '91-93 РАДИАТОР ОХЛАЖДЕН (NISSENS)						625 379 32
				AROSA 1,0 i	999 AER	G	M	*	97/2-99/9
				AROSA 1,0 i	999 AHT	G	M	*	98/11-00/2
				AROSA 1,0 i	999 ALD	G	M	*	98/11-00/2
				AROSA 1,0 i	999 ALL	G	M	*	97/8-99/5
				AROSA 1,0 i	999 ANV	G	M	*	99/7-00/7
				AROSA 1,0 i	999AUC	G	M	*	00/7-03/5
				AROSA 1,0 i	999 AUC	G	M	*	03/5-
				AROSA 1,4 i	1390 AEX	G	M	*	97/2-97/11
				AROSA 1,4 i	1390 AEX	G	A	*-/	97/2-97/11
				AROSA 1,4 i	1390 AEX	G	A	*-/	97/2-97/11
				AROSA 1,4 i	1390 AFK	G	M	*	00/2-00/9
				AROSA 1,4 i	1390AKK	G	M	*	99/7-00/10
				AROSA 1,4 i	1390AKK	G	A	*-/	99/7-00/10
				AROSA 1,4 i	1390 AKV	G	M	*	97/5-99/9
				AROSA 1,4 i	1390 AEX	G	A	*-/	97/2-97/11
				AROSA 1,4 i	1390 AFK	G	M	*	002/00/9
				AROSA 1,4 i	1390 AKK	G	M	*	99/7-00/10
				AROSA 1,4 i	1390 AKK	G	A	*-/	99/7-00/10
				AROSA 1,4 i	1390 AKV	G	M	*	97/5-99/9
				AROSA 1,4 i	1390 AKV	G	A	*-/	97/5-99/9
AROSA 1,4 i	1390 ANW	G	M	*	99/7-00/10				
AROSA 1,4 i	1390 ANW	G	A	*-/	99/7-00/10				
AROSA 1,4 i	1390 APQ	G	M	*	97/12-98/8				
AROSA 1,4 i	1390 APQ	G	M	*	97/12-98/8				

№ФОРВАРДА	№ OEM	№ NISSENS	МОДЕЛЬ	ТИП ДВИГАТЕЛЯ	БЕН/Д ИЗ	ТИП КП	КОНД ИЦИ	ГОД	ПРИМЕЧА НИЕ
			AROSA 1,4 i	1390 APQ	G	A	*/-	97/12-98/8	
			AROSA 1,4 i	1390 AUD	G	M	*	00/9-03/5	
			AROSA 1,4 i	1390 AUD	G	A	*/-	00/9-03/5	
			AROSA 1,4 i	1390 AUD	G	M	*	03/5-	
			AROSA 1,4 i	1390 AUD	G	A	*/-	03/5-	
			AROSA 1,4 i 16V	1391 AQQ	G	M	*	99/10-00/9	
			AROSA 1,4 i 16V	1391 AUB	G	M	*	00/9-03/5	
			AROSA 1,4 i 16V	1390 AUB	G	M	*	03/5-	
			AROSA 1,4 i Tdi	1390 AMF	D	M	*	03/5-	
			AROSA 1,4Tdi	1422 AMF	D	M	*	99/10-03/5	
			CADDY 1,7 Sdi	1714 AHB	D	M	*	96/7-00/9	
			CADDY 1,9 Sdi	1896 AEY	D	M	*	95/11-00/9	
			CADDY 1,9 Tdi	1896 AHU	D	M	*	96/10-00/9	
			CADDY 1,9 Tdi	1896 ALE	D	M	*	97/9-00/9	
			CADDY 1,9 Tdi	1896 1Z	D	M	*	96/10-97/3	
			CORDOBA 1,4i	1391 ABD	G	M	*	93/9-95/11	
			CORDOBA 1,4i	1391 AEX	G	M	*	95/9-96/6	
			CORDOBA 1,4i 16V	1390 AEF	G	M	*	97/5-98/12	
			CORDOBA 1,4i 8V	1390 AEX	G	M	*	96/7-97/12	
			CORDOBA 1,4i 8V	1390 AKV	G	M	*	97/12-99/6	
			CORDOBA 1,4i 8V	1390 ANX	G	M	*	98/1-98/5	
			CORDOBA 1,4i 8V	1390 ARQ	G	M	*	97/12-99/6	
			CORDOBA 1,6i	1595 1F	G	M/A	*	96/7-99/6	
			CORDOBA 1,6i 8V	1598 AEE	G	M	*	96/7-99/6	
			CORDOBA 1,6i 8V	1598 AFT	G	M	*/-	97/9-99/6	
			CORDOBA 1,8i	1781 ACC	G	M	*	96/7-99/6	
			CORDOBA 1,8i	1781 ADZ	G	M	*	96/7-99/6	
			CORDOBA 1,9 Sdi	1896 AEY	D	M	*	95/9-96/6	
			CORDOBA 1,9 Sdi	1896 AEF	D	M	*	96/7-99/7	
			CORDOBA 1,9 Tdi	1896 AAZ	D	M	*	96/7-97/8	
			CORDOBA 1,9 Tdi	1896 AFN	D	M	*	97/3-99/6	
			CORDOBA 1,9 Tdi	1896 AHU	D	M	*	96/12-99/6	
			CORDOBA 1,9 Tdi	1896 1Z	D	M	*	96/7-96/12	
			CORDOBA 2,0i	1984 ABF	G	M	*	96/7-99/6	
			CORDOBA 2,0i	1984 AGG	G	M	*	96/7-99/6	
			GOLF III 2,8 VR6	2792 AAA	G	M/A	*/-	92/1-97/12	
			IBIZA 1,4i	1391 ABD	G	M	*	93/9-95/11	
			IBIZA 1,4i	1390 AEX	G	M	*	95/9-97/12	
			IBIZA 1,4i	1398 AKV	G	M	*	97/12-99/6	
			IBIZA 1,4i	1390 ANX	G	M	*	98/1-98/5	
			IBIZA 1,4i	1390 APQ	G	M	*	97/12-99/6	
			IBIZA 1,4i 16V	1390 AFH	G	M	*	97/6-99/6	
			IBIZA 1,6i	1595 ABU	G	M	*	93/2-94/8	
			IBIZA 1,6i	1595 AEE	G	M	*	97/5-98/12	
			IBIZA 1,6i	1595 AFT	G	M	*	95/9-99/6	
			IBIZA 1,6i	1598 ALM	G	M	*	97/9-99/6	
			IBIZA 1,6i	1595 1F	G	M/A	*	94/5-99/6	
			IBIZA 1,8i	1781 ACC	G	M	*	95/3-99/6	
			IBIZA 1,8i	1781 ADZ	G	M/A	*	94/9-99/6	
			IBIZA 1,9 D	1898 1Y	D	M	*	93/2-99/6	
			IBIZA 1,9 Sdi	1896 AEY	D	M	*	95/9-99/6	
			IBIZA 1,9 TD	1896 AAZ	D	M	*	93/2-97/8	
			IBIZA 1,9 Tdi	1896 AFN	D	M	*	97/3-99/6	
			IBIZA 1,9 Tdi	1896AHU	D	M	*	96/12-99/6	

№ФОРВАРДА	№ OEM	№ NISSENS	МОДЕЛЬ	ТИП ДВИГАТЕЛЯ	БЕН/Д ИЗ	ТИП КП	КОНД ИЦИ	ГОД	ПРИМЕЧА НИЕ
			IBIZA 2,0 i	1984 AGG	G	M	*	96/4-99/6	
			IBIZA 2,0 i 16V	1984 ABF	G	M	*	96/7-99/6	
			INCA 1,7 Sdi	1714 AHB	D	M	*	96/7-00/9	
			INCA 1,9 Sdi	1896 AEY	D	M	*	95/11-00/9	
			JETTA 2,8 i VR6	2792 AAA	G	M/A	*/-	92/1-97/12	
			LUPO 1,0 i	999 AER	G	M	*	99/1-00/5	
			LUPO 1,0 i	999 AHT	G	M	*	98/10-00/5	
			LUPO 1,0 i	999 ALD	G	M	*	99/5-03/5	
			LUPO 1,0 i	999 ALL	G	M	*	98/10-00/5	
			LUPO 1,0 i	999 ANV	G	M	*	99/5-00/5	
			LUPO 1,0 i	999 AUC	G	M	*	00/5-03/5	
			LUPO 1,0i	999 ALD	G	M	*	03/6-	
			LUPO 1,0i	999 AUC	G	M	*	03/6-	
			LUPO 1,2 Tdi	1191 ANY	D	M	*	99/6-00/11	
			LUPO 1,2 Tdi	1191 AYZ	D	M	*	00/11-03/5	
			LUPO 1,4 FSI	1391 APR	G	M	*	03/6-03/11	
			LUPO 1,4 i	1391 AUD	G	M	*	00/9-03/5	
			LUPO 1,4 i	1390 AUD	G	M	*	03/6-	
			LUPO 1,4 i 16V	1390 AHW	G	M	*	03/6-04-	
			LUPO 1,4 i 16V	1390 AHW	G	A	*/-	03/6-04/5	
			LUPO 1,4 i 16V	1390 AUB	G	M	*	03/6-03/11	
			LUPO 1,4 i 16V	1390 BBY	D	M	*	03/6-	
			LUPO 1,4 i 16V	1390 BBY	D	A	*/-	03/6-	
			LUPO 1,4 i 16V	1391 AFK	G	M	*	00/5-00/10	
			LUPO 1,4 i 16V	1391 AHW	G	M	*	99/1-03/5	
			LUPO 1,4 i 16V	1391 AHW	G	A	*/-	99/1-03/5	
			LUPO 1,4 i 16V	1391 AKQ	G	M	*	98/10-99/5	
			LUPO 1,4 i 16V	1391 AKQ	G	A	*/-	98/10-99/5	
			LUPO 1,4 i 16V	1391 APE	G	M	*	99/5-00/5	
			LUPO 1,4 i 16V	1391 APE	G	A	*/-	99/5-00/5	
			LUPO 1,4 i 16V	1391 AQQ	G	M	*	99/5-00/5	
			LUPO 1,4 i 16V	1391 AUA	G	M	*	00/5-02/4	
			LUPO 1,4 i 16V	1391 AUA	G	A	*/-	00/5-02/4	
			LUPO 1,4 i 16V	1391 AUB	G	M	*	00/5-03/5	
			LUPO 1,4 i 16V	1391 BBY	G	M	*	02/4-03/5	
			LUPO 1,4 i 16V	1391 BBY	G	A	*/-	02/4-03/5	
			LUPO 1,4 i 16V	1598 AVY	G	M	*/-	01/4-03/5	
			LUPO 1,4 i Fsi	1391 ARR	G	M	*	00/9-03/5	
			LUPO 1,4 i Tdi	1422 AMF	D	M	*	99/5-03/5	
			LUPO 1,4 Tdi	1390 AMF	D	M	*	03/6-	
			PASSAT 2,8 i VR6	2792 AAA	G	M	*	91/6-93/10	
			POLO 1,0	999 AER	G	M	*	96/7-99/12	
			POLO 1,0	999ALL	G	M	*	97/8-99/12	
			POLO 1,0i 8V	999 ALD	G	M	*	00/5-01/9	
			POLO 1,0i 8V	999 ALD	G	M	*	00/5-01/9	
			POLO 1,0i 8V	999 ALD	G	A	*/-	00/5-01/9	
			POLO 1,0i 8V	999AUC	G	M	*	99/10-01/9	
			POLO 1,0i 8V	999AUC	G	A	*/-	99/10-01/9	
			POLO 1,4 i 16V	1390 AHW	G	A	*/-	99/10-01/9	
			POLO 1,4 i 16V	1390 APE	G	A	*/-	00/5-00/12	

№ФОРВАРДА	№ OEM	№ NISSENS	МОДЕЛЬ	ТИП ДВИГАТЕЛЯ	БЕН/Д ИЗ	ТИП КП	КОНД ИЦИ	ГОД	ПРИМЕЧА НИЕ
			POLO 1,4 i 16V	1598 ARC	G	M	*/-	99/11-01/9	
			POLO 1,4 i 8V	1390 AKK	G	M	*	99/10-01/9	
			POLO 1,4 i 8V	1390AKK	G	A	*/-	99/10-01/9	
			POLO 1,4 i 8V	1390 AKP	G	M	*	99/10-01/9	
			POLO 1,4 i 8V	1390 AKP	G	A	*/-	99/10-01/9	
			POLO 1,4 i 8V	1390 AUD	G	M	*	99/10-01/9	
			POLO 1,4 i 8V	1390 AUD	G	A	*/-	99/10-01/9	
			POLO 1,4i	1390 AEX	G	M	*	95/7-97/12	
			POLO 1,4i	1390 AEX	G	A	*/-	95/7-97/12	
			POLO 1,4i	1390 AKV	G	M	*	97/5-99/12	
			POLO 1,4i	1390 AKV	G	A	*/-	97/5-99/12	
			POLO 1,4i	1390 ANX	G	M	*	98/1-99/12	
			POLO 1,4i	1390 ANX	G	A	*/-	98/1-99/12	
			POLO 1,4i	1390 APQ	G	M	*	97/11-99/12	
			POLO 1,4i	1390 APQ	G	A	*/-	97/11-99/12	
			POLO 1,4i 16V	1390 AFH	G	M	*	96/4-99/12	
			POLO 1,6 i 16V	1598 AVY	G	M	*/-	00/5-01/9	
			POLO 1,6i	1598 AEA	G	M	*	94/10-95/7	
			POLO 1,6i	1598 AEE	G	M	*	95/7-99/12	
			POLO 1,6i	1598AEE	G	A	*/-	95/7-99/12	
			POLO 1,6i 16 V	1598 AJV	G	M	*/-	98/8-99/12	
			POLO CLASSIC 1,4	1398 AEX	G	M	*	96/5-97/12	
			POLO CLASSIC 1,4	1398 AKV	G	M	*	97/12-99/8	
			POLO CLASSIC 1,4	1398 ANX	G	M	*	98/1-99/8	
			POLO CLASSIC 1,4	1398 APQ	G	M	*	97/12-99/8	
			POLO CLASSIC 1,6i	1598 AEE	G	M	*	97/9-98/12	
			POLO CLASSIC 1,6i	1598 AFT	G	M	*	96/5-99/8	
			POLO CLASSIC 1,6i	1598 ALM	G	M	*	98/7-99/8	
			POLO CLASSIC 1,6i	1598 1F	G	M	*	96/5-97/9	
			POLO CLASSIC 1,7 Sdi	1716 AKW	D	M	*	97/11-99/8	
			POLO CLASSIC 1,8 i	1781 ADD	G	M	*	00/3-01/9	
			POLO CLASSIC 1,8i	1781 ADD	G	M	*	98/3-99/8	
			POLO CLASSIC 1,9 Tdi	1896 AFN	D	M	*	98/6-99/8	
			POLO CLASSIC 1,9 Tdi	1896 AHU	D	M	*	97/1-99/9	
			POLO CLASSIC 1,9 Tdi	1896 ALE	D	M	*	97/11-99/8	
			POLO CLASSIC 1,9D	1896 1Y	D	M	*	96/5-96/10	
			POLO CLASSIC 1,9SDi	1896 AEY	D	M	*	96/5-98/8	
			POLO CLASSIC 2,0 i	1984 ADC	G	M	*	00/6-01/9	
			VENTO 2,8 VR6	2792 AAA	G	M/A	*/-	92/1/98/12	

VWPAS91-912 357121251C/B/L

65249





PASSAT '91-93 РАДИАТОР ОХЛАЖДЕН

720 348 33



PASSAT 1,6 TD	1588 SB	D	M	*	
PASSAT 1,8 i	1781 AMM	G	M	*	90/8-93/10
PASSAT 1,8 i	1781 ABS	G	M/A	*	91/8-93/10
PASSAT 1,9 TD	1896 AAZ	D	M/A	*	
PASSAT 2,0 i	1984 ACX	G	M	*	93/6-93/10
PASSAT 2,0 i	1984 2E	G	M/A	*	90/3-93/10
PASSAT 2,0 i	1984 9A	G	M/A	*	88/4-93/10
PASSAT 2,8 i VR6	2792 AAA	G	M	*	91/6-93/10
PASSAT 2,8 i VR6	2792 AAA	G	A	*/-	

CN

№ФОРВАРДА	№ OEM	№ NISSENS	МОДЕЛЬ	ТИП ДВИГАТЕЛЯ	БЕН/Д ИЗ	ТИП КП	КОНД ИЦИ	ГОД	ПРИМЕЧА НИЕ			
VWPAS93-910	3A0121253	65251A	PASSAT '93-96 РАДИАТОР ОХЛАЖДЕН (NISSENS)						521 379 32			
VWPAS93-913	3A0121253	65251A	PASSAT '93-96 РАДИАТОР ОХЛАЖДЕН						521 379 32			
			PASSAT IV 1,6I/CL/GL	1588AEK	G	M		9/93-9/96				
			PASSAT IV 1,6TD	1588	D	M		9/93-10/93				
			PASSAT IV 1,8I/CL/GL	1781AAM	G	M		9/93-9/96				
			PASSAT IV 1,8I/CL/GL/GT	1781ADZ	G	M		9/94-9/96				
			PASSAT IV 1,8I/CL/GL/GT	1781ABS	G	M		9/93-9/94				
			PASSAT IV 2,0I/CL/GL	1998AEP	G	M		2/95-9/96				
			PASSAT IV 2,0I/CL/GL	1998ACX	G	M		3/94-1/95				
			PASSAT IV 2,0I/CL/GL/GT	1984 2E	G	M		10/93-9/96				
			PASSAT IV 2,0I/CL/GL/GT	1998ADY	G	M		10/94-9/96				
			PASSAT IV 2,0I/GL/GT/16V	1984ABF	G	M		1/94-9/96				
			PASSAT IV SYNCRO 2,0I/CL/GL/G	1984 2E	G	M		1/94-9/94				
			PASSAT IV SYNCRO 2,0I/CL/GL/G	1998ADY	G	M		10/94-9/96				
			VWPAS93-911	3A0121253AB	65256	PASSAT '93-96 РАДИАТОР ОХЛАЖДЕН (NISSENS)						722 359 32
			VWPAS93-914	3A0121253AB/1HM121253H	65256A	PASSAT '93-96 РАДИАТОР ОХЛАЖДЕН						722 359 32
			PASSAT IV 1,9TDI	1896 1Z	D	MA	*	10/93-9/96				
			PASSAT IV 1,9TURBO D	1896AAZ	D	M	*	10/93-9/96				
			PASSAT IV 2,0I/CL/GL	1998ACX	G	A	*	3/94-1/95				
			PASSAT IV 2,0I/CL/GL	1998AEP	G	A	*	2/95-9/96				
			PASSAT IV 2,0I/CL/GL/GT	1984 2E	G	A	*	10/93-9/96				
			PASSAT IV 2,0I/CL/GL/GT	1998ADY	G	A	*	10/94-9/96				
			PASSAT IV 2,0I/GL/GT/16V	1984ABF	G	A	*	1/94-9/96				
			PASSAT IV 2,8I/GL/GLS/GT/VR6	2792AAA	G	A	*/-	10/93-9/96				
			VWPAS93-912	3A0121253AA	65253A	PASSAT '93-96 РАДИАТОР ОХЛАЖДЕН (NISSENS)						524 379 32
						PASSAT IV 1,6I/CL/GL	1588AEK	G	A		9/93-9/96	
PASSAT IV 1,6TD	1588	D				M		10/93-9/96				
PASSAT IV 1,8I/CL/GL/GT	1781ADZ	G				A		9/94-9/96				
PASSAT IV 1,8I/CL/GL/GT	1781ABS	G				A		10/93-9/94				
PASSAT IV 1,9 TURBO D	1896AAZ	D				M		10/93-9/96				
PASSAT IV 1,9D	1896 1Y	D				M	*/-	10/93-9/96				
PASSAT IV 1,9TDI	1896 1Z	D				M		10/93-9/96				
PASSAT IV 2,0I/CL/GL	1998AEP	G				A		2/95-9/96				
PASSAT IV 2,0I/CL/GL	1998ACX	G				A		3/94-1/95				
PASSAT IV 2,0I/CL/GL/GT	1984 2E	G				A		10/93-9/96				
PASSAT IV 2,0I/CL/GL/GT	1998ADY	G				A		10/94-9/96				
PASSAT IV 2,0I/GL/GT/16V	1984ABF	G				A		1/94-9/96				
VWPAS93-915	3A0121253C/E/T	65252				PASSAT '93-96 РАДИАТОР ОХЛАЖДЕН						722 377 33
			PASSAT IV 1,6I/CL/GL	1588AEK	G	M	*	09/93-09/96				
			PASSAT IV 1,8I/CL/GL	1781ABS	G	M	*	09/93-09/96				
			PASSAT IV 1,8I/CL/GL/GT	1781ABS	G	M	*	10/93-09/94				
			PASSAT IV 1,8I/CL/GL/GT	1781ADZ	G	M	*	09/94-09/96				
			PASSAT IV 2,0I/CL/GL	1998AEP	G	M	*	02/95-09/96				
			PASSAT IV 2,0I/CL/GL	1984ACX	G	M	*	03/94-01/95				
			PASSAT IV 2,0I/CL/GL/GT	1984 2E	G	M	*	10/93-09/96				
			PASSAT IV 2,0I/CL/GL/GT	1998ADY	G	M	*	10/94-09/96				
			PASSAT IV 2,0I/GL/GT/16V	1984ABF	G	M	*	01/94-09/96				
			PASSAT IV 2,8I/GL/GLS/GT/VR6	2792AAA	G	M	*/-	10/93-09/96				
			PASSAT IV SYNCRO 2,0I/CL/GL/G	1984 2E	G	M	*	01/94-09/94				
			PASSAT IV SYNCRO 2,0I/CL/GL/G	1998ADY	G	M	*	10/94-09/96				
			PASSAT IV SYNCRO 2,9I/VR6	2861ABV	G	M	*/-	10/93-09/96				

№ФОРВАРДА	№ OEM	№ NISSENS	МОДЕЛЬ	ТИП ДВИГАТЕЛЯ	БЕН/Д ИЗ	ТИП КП	КОНД ИЦИ	ГОД	ПРИМЕЧА НИЕ
VWPLC96-910	6K0121253A/Q/C	63997	POLO CLASSIC '96- {IBIZA/CORDOBA 93-99} РАДИАТОР ОХЛАЖДЕН (NISSENS)						628 322 22
VWPLC96-913	6K0121253A/Q	63997	POLO CLASSIC '96- {IBIZA/CORDOBA 93-99} РАДИАТОР ОХЛАЖДЕН						628 322 22
			CORDOBA 1,8 16V CORDOBA 2,0GLX/GT IBIZA II 1,8 16V IBIZA II 1,9D IBIZA II 2,0GLX/GT IBIZA II 2,0GT 16V POLO CLASSIC 1,6S	1781 1984 1781ADL 1896 1Y 1984 2E/AGG 1984 2E 1598AFT	G G G D G G G	M M M M M M M	* * * * * * *	10/94- 12/93- 10/94-8/96 10/94-8/96 3/93-8/99 12/93-7/97 3/96-	
VWPLC96-911	6K0121253L/IHM121253D	65255A	POLO CLASSIC '96- {IBIZA 93-99/COLF III 92-97/CADDY} РАДИАТОР ОХЛАЖДЕН						625 379 32
			CADDY II 1,9SDI CORDOBA 1,4CL/CLX/GLX CORDOBA 1,6CLX/GLX GOLF III 2,8 VR6 MEX IBIZA II 1,4CL/CLX/GLX IBIZA II 1,6CLX/GLX INCA 1,6I INCA 1,9SDI POLO CLASSIC 1,4 POLO CLASSIC 1,9SDI	1896AEY 1391 1595 2792AAA 1391APG/ABD/AEX/AKV 1595 1595 1896AEY 1398AEX 1896AEY	D G G G G G D G D	M M M M M M M M M	* * * * * * * * *	10/95- 12/93-6/99 12/93- 1/92- 9/93-8/99 5/93- 4/95- 10/95- 3/96- 3/96-	
VWPLC96-912	6K0121253M/IHO121253C/P	65244A	POLO CLASSIC '96- {COLF III 91-/CORDOBA/IBIZA/INCA/CADDY} РАДИАТОР ОХЛАЖДЕН (NISSENS)						625 379 32
			CADDY II 1,6 CADDY II 1,9D CORDOBA 1,8 16V CORDOBA 1,8CLX/GLX CORDOBA 1,9 TURBO D CORDOBA 1,9D CORDOBA 2,0GLX/GT GOLF III 1,9D MEX IBIZA II 1,8 16V IBIZA II 1,8CLX/GLX IBIZA II 1,9 TURBO D IBIZA II 1,9D IBIZA II 1,9D IBIZA II 1,9D IBIZA II 2,0GLX/GT INCA 1,9D POLO CLASSIC 1,6 POLO CLASSIC 1,6S POLO CLASSIC 1,9D	1595 1F 1896 1Y 1781 1781ABS/ADL 1896 1896 1984 2E 1Y 1781ADL 1781ABS/ADZ 1896AAZ 1896 1Y 1896 1Y 1984 2E/AGG 1896 1Y 1598 1F 1598AFT 1896 1Y	G D G G D D G D D G G D D D G D G G D	M M M M M M M M M M M M M M M M M M M	* * * * * * * * * * * * * * * * *	10/95- 10/95- 10/94- 12/93- 12/93- 12/93- 12/93- 9/91- 10/94-8/96 3/93-8/99 3/93-8/96 4/93-8/96 10/94-8/96 3/93-8/99 4/95- 3/96- 3/96- 3/96-	
VWPL094-910	6N0121253M	65233A	POLO '94-99 РАДИАТОР ОХЛАЖДЕН (NISSENS)						626 377 32
			POLO IV 1,3 POLO IV 1,4/1,4 16V POLO IV 1,4/1,4 16V POLO IV 1,6 POLO IV 1,6 POLO IV 1,9D	1272ADX 1398AEX/AFH 1398AEX/AFH 1598AEA/AEE/AHS 1598AEA/AEE/AHS 1896AEF	G G G G G D	M M A M M M	* * * * * *	10/94- 10/94- 10/94- 10/94- 10/94- 10/94-	

№ ФОРВАРДА	№ OEM	№ NISSENS	МОДЕЛЬ	ТИП ДВИГАТЕЛЯ	БЕН/Д ИЗ	ТИП КП	КОНД ИЦИ	ГОД	ПРИМЕЧА НИЕ
VW PLO96-910	6N0121253K/AE	65234	POLO '97- {+LUPO 98-} РАДИАТОР ОХЛАЖДЕН						430 359 22
			AROSA (97-) 1.0 i	AER/AEX/AUC/ANV/ALL/AI	G	M	-	02/97 - 09/99	
			AROSA (97-) 1.4 i	AEX/AUD/APQ/ANW/AKV/A	G	M	-	02/97 - 11/97	
			AROSA (97-) 1.4 i 16V	AQQ/AUB	G	M	-	10/99 - 09/00	
			AROSA (97-) 1.4 Tdi	AMF	D	M	-	10/99 - 05/03	
			AROSA (97-) 1.7 Sdi	AKU	D	M	-	08/97 - 05/03	
			AROSA (03-) 1.4 i 16V	AUB	G	M	-	05/03 -	
			AROSA (03-) 1.4 Tdi	AMF	D	M	-	05/03 -	
			AROSA (03-) 1.7 Sdi	AKU	D	M	-	05/03 - 10/03	
			LUPO (98-) 1.0 i	AER/AUC/ANV/ALL/ALD/AI	G	M	-	01/99 - 05/00	
			LUPO (98-) 1.4 i	AUD	G	M	-	09/00 - 05/03	
			LUPO (98-) 1.4 i 16V	AFK/BBY/AUB/AUA/AQQ/AI	G	M	-	05/00 - 10/00	
			LUPO (98-) 1.7 Sdi	AKU	D	M	-	10/98 - 05/03	
			LUPO (03-) 1.0 i	ALD/AUC	G	M	-	06/03 -	
			LUPO (03-) 1.2 Tdi	AYZ	D	M	-	06/03 -	
			LUPO (03-) 1.4 i	AUD	G	M	-	06/03 -	
			LUPO (03-) 1.4 i 16V	AHW/AUB	G	M	-	06/03 -	
			LUPO (03-) 1.4 i 16V	BBY	D	M	-	06/03 -	
			LUPO (03-) 1.4 Tdi	AMF	D	M	-	06/03 -	
			LUPO (03-) 1.7 Sdi	AKU	D	M	-	06/03 -	
			POLO (94-) 1.0	AER/ALL	G	M	-	07/96 - 12/99	
POLO (94-) 1.5	AEV	G	M	-	10/94 - 06/96				
POLO (94-) 1.3	ADX	G	M	-	10/94 - 04/97				
POLO (94-) 1.4 i	ANX/APQ/AKV/AEX	G	M	-	01/98 - 12/99				
POLO (94-) 1.4 i 16V	AFH	G	M	-	04/96 - 12/99				
POLO (94-) 1.6 i	AEA/AEE	G	M	-	10/94 - 07/95				
POLO (94-) 1.7 Sdi	AHG/AKU	D	M	-	04/97 - 12/99				
POLO (94-) 1.9 Sdi	AGD	D	M	-	07/96 - 12/99				
POLO (99-) 1.0 i	ALD/AUC	G	M	-	05/00 - 09/01				
POLO (99-) 1.4 i	AKK/AUD/AKP	G	M	-	10/99 - 09/01				
POLO (99-) 1.4 i 16V	AFK/AUB/AHW/AUA	G	M	-	10/99 - 09/01				
POLO (99-) 1.7 Sdi	AKU	D	M	-	10/99 - 04/00				
POLO (99-) 1.9 Sdi	AGD/ASX	D	M	-	10/99 - 09/01				
VW TRN90-910	701121253/B	65184	TRANSPORTER '90-91 РАДИАТОР ОХЛАЖДЕН (NISSENS)						720 302 33
VW TRN90-911		65184	TRANSPORTER '90-91 РАДИАТОР ОХЛАЖДЕН						720 302 33
			TRANSPORTER T4 (90-) 1.8 i	PD	G	M	-	09/90 - 07/92	
			TRANSPORTER T4 (90-) 1.9 D	IX	D	M	-	09/90 - 07/94	
			TRANSPORTER T4 (90-) 2.0 i	AAC	G	M	+/-	09/90 - 07/94	
			TRANSPORTER T4 (90-) 2.4 D	AAB	D	M	-	09/90 - 07/94	
			TRANSPORTER T4 (90-) 2.5 i	ACU	G	M/A	-	02/94 - 07/94	
			TRANSPORTER T4 (90-) 2.5 i	AAF	G	M/A	-	09/90 - 12/93	
VW TRN91-910	701121253D/K/F	65242A	TRANSPORTER '91-96 РАДИАТОР ОХЛАЖДЕН (NISSENS)						718 359 32
VW TRN91-911		65242	TRANSPORTER '91-96 РАДИАТОР ОХЛАЖДЕН						718 359 32
			TRANSPORTER T4 (90-) 1.8 i	PD	G	M	-	09/90 - 07/92	
			TRANSPORTER T4 (90-) 1.9 D	IX	D	M	-	09/90 - 12/95	
			TRANSPORTER T4 (90-) 1.9 TD	ABL	D	M	+/-	10/92 - 06/03	
			TRANSPORTER T4 (90-) 2.0 i	AAC	G	M/A	+/-	09/90 - 06/03	
			TRANSPORTER T4 (90-) 2.4 D	AJA	D	M/A	+/-	04/97 - 06/03	
			TRANSPORTER T4 (90-) 2.4 D	AAB	D	M	+/-	09/90 - 04/98	
			TRANSPORTER T4 (90-) 2.5 i	ACU/AAF/AVT/APL/AEU/AE	G	M/A	+/-	02/94 - 10/96	
			TRANSPORTER T4 (90-) 2.5 Tdi	ACV/AJT/AHY	D	M	+/-	09/95 - 06/03	
			TRANSPORTER T4 (90-) 2.5 Tdi	ACV/AUF	D	A	+/-	05/98 - 06/03	
TRANSPORTER T4 (90-) 2.8 i V6	AMV	G	A	+/-	05/00 - 06/03				

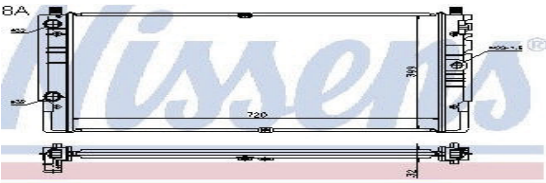
№ ФОРВАРДА	№ OEM	№ NISSENS	МОДЕЛЬ	ТИП ДВИГАТЕЛЯ	БЕН/Д ИЗ	ТИП КП	КОНД ИЦИ	ГОД	ПРИМЕЧА НИЕ
VWTRN96-910	7D0121253	65238A	TRANSPORTER '96- РАДИАТОР ОХЛАЖДЕН (NISSENS)						720 399 32
VWTRN96-911		65238	TRANSPORTER '96- РАДИАТОР ОХЛАЖДЕН						720 399 32
				TRANSPORTER T4 (90-) 1.9 TD	ABL	D	M	+/-	09/96 - 06/03
				TRANSPORTER T4 (90-) 2.0 i	AAC	G	M/A	+/-	09/96 - 06/03
				TRANSPORTER T4 (90-) 2.4 D	AJA	D	M/A	+/-	04/97 - 06/03
				TRANSPORTER T4 (90-) 2.4 D	AAB	D	M	+/-	09/96 - 04/98
				TRANSPORTER T4 (90-) 2.5 i	AET/AVT/APL/AEU	G	M/A	+/-	08/96 - 06/03
				TRANSPORTER T4 (90-) 2.5 Tdi	ACV/AJT/AYY	D	M	+/-	09/96 - 06/03
				TRANSPORTER T4 (90-) 2.5 Tdi	AUF	D	A	+/-	11/99 - 06/03
				TRANSPORTER T4 (90-) 2.5 Tdi	AYC	D	M/A	+/-	04/01 - 06/03
				TRANSPORTER T4 (90-) 2.8 i V6	AMV	G	A	+/-	05/00 - 06/03
				TRANSPORTER T4 (90-) 2.8 i VR6	AES	G	M/A	+/-	01/96 - 05/00

КОНДЕНСАТОРЫ КОНДИЦИОНЕРА

№ ФОРВАРДА	№ OEM	№ NISSENS	МОДЕЛЬ	ТИП ДВИГАТЕЛЯ	БЕН/Д ИЗ	ТИП КП	КОНД ИЦИ	ГОД	ПРИМЕЧА НИЕ
AI08092-930	8A0260403AA	94209	AUDI 80 '92-94 КОНДЕНСАТОР КОНДИЦ (NISSENS)						605 350 25
AI08092-931	8A0260403AA	94209	AUDI 80 '92-94 КОНДЕНСАТОР КОНДИЦ						605 350 25
				80/90 1,6	1595ADA	G	M	*	93/9-95/7
				80/90 1,6 i	1588ABB	G	M	*	92/3-93/5
				80/90 2,0i	1984ABK	G	M	*	91/9-95/7
				80/90 2,0i	1984ABK	G	A	*/-	91/9-95/7
				80/90 2,0i	1984ABT	G	M	*	91/9-95/6
				80/90 2,0i	1984ABT	G	A	*/-	91/9-95/6
				80/90 2,0i	1984ADW	G	M	*	93/12-95/6
				80/90 2,0i	1984ADW	G	A	*/-	93/12-95/9
				80/90 2,6 i V6	2598ABC	G	M	*/-	92/7-95/7
				80/90 2,6 i V6	2598ABC	G	A	*/-	92/7-95/7
				80/90 2,6 i V6	2598ACZ	G	M	*/-	92/7-95/7
				80/90 2,6 i V8	2771AHH	G	M	*/-	91/9-95/7
				80/90 2,6 i V8	2771AHH	G	A	*/-	91/9-95/7
				80/90 QUATTRO 2,0E	1994ABK	G	M	*	91/9-94/12
				80/90 QUATTRO 2,6E	2598ABC	G	M	*/-	92/7-94/12
				80/90 QUATTRO 2,8E	2771AAH	G	M	*/-	91/9-94/12
				CABRIOLET 1,8 i	1781ADR	G	M	*/-	97/4-00/8
				CABRIOLET 1,8 i	1781ADR	G	A	*/-	97/4-00/8
				CABRIOLET 2,0	1994ABK	G	M	*	93/1-98/9
				CABRIOLET 2,0	1994ACE	G	M	*/-	95/5-96/7
				CABRIOLET 2,6i V6	2598ABC	G	M	*/-	94/1-00/8
				CABRIOLET 2,6i V6	2598ABC	G	A	*/-	94/1-00/8
				CABRIOLET 2,8i V6	2771AAH	G	M	*/-	92/11-00/8
				CABRIOLET 2,8i V6	2771AAH	G	A	*/-	92/11-00/8
				COUPE 2,0 I	1984ABK	G	M	*	91/8-95/12
COUPE 2,0 I	1984ABK	G	A	*/-	91/8-95/12				
COUPE 2,0 I	1984ACE	G	M	*	92/8-95/12				
COUPE 2,6 i V6	2598ABC	G	M	*/-	92/8-95/12				
COUPE 2,6 i V6	2598ABC	G	A	*/-	92/8-95/12				
COUPE 2,8 i V6	2771 AAH	G	M	*/-	91/8-95/12				
COUPE 2,8 i V6	2771AAH	G	A	*/-	91/8-95/12				
COUPE QUATTRO 2,6iV6	2598ABC	G	M	*/-	88/11-94/7				
COUPE QUATTRO 2,8iV6	2771AHH	G	M	*/-	88/11-94/7				

№ ФОРВАРДА	№ OEM	№ NISSENS	МОДЕЛЬ	ТИП ДВИГАТЕЛЯ	БЕН/Д ИЗ	ТИП КП	КОНД ИЦИ	ГОД	ПРИМЕЧА НИЕ
A10A396-930	1J0820413D	94310	AUDI A3 '96- {OCTAVIA/COLFIV/TOLEDO 98-/BORA} КОНДЕНСАТОР КОНДИЦ						590 361 16
A10A396-931	1J0820413A/B/D/E	94310	AUDI A3 '96- {OCTAVIA/COLFIV/TOLEDO 98-/BORA} КОНДЕНСАТОР КОНДИЦ (NISSENS)						590 361 16
			AUDI A3/S3 1,6i	1588 AEH	G	M/A	*/-	96/9-	
			AUDI A3/S3 1,6i	1588 AKL	G	M/A	*/-	96/9-	
			AUDI A3/S3 1,6i	1588 AVU	G	M/A	*/-	96/9-	
			AUDI A3/S3 1,6i	1588 APF	G	M/A	*/-	96/9-	
			AUDI A3/S3 1,6i	1588 BFQ	G	M/A	*/-	96/9-	
			AUDI A3/S3 1,8 i 20V	1781 AGN	G	M/A	*/-	96/9-	
			AUDI A3/S3 1,8 i 20V	1781 APG	G	M/A	*/-	96/9-	
			AUDI A3/S3 1,8 i TURBO 20V	1781 AGU	G	A	*/-	96/9-	
			AUDI A3/S3 1,8 i TURBO 20V	1781 AMK	G	M/A	*/-	96/9-	
			AUDI A3/S3 1,8 i TURBO 20V	1781 AQA	G	M/A	*/-	96/9-	
			AUDI A3/S3 1,8 i TURBO 20V	1781 ARX	G	M/A	*/-	96/9-	
			AUDI A3/S3 1,8 i TURBO 20V	1781 APY	G	M/A	*/-	96/9-	
			AUDI A3/S3 1,8 i TURBO 20V	1781 AUL	G	M/A	*/-	96/9-	
			AUDI A3/S3 1,8 i TURBO 20V	1781 AUM	G	M/A	*/-	96/9-	
			AUDI A3/S3 1,8 i TURBO 20V	1781 AUQ	G	M/A	*/-	96/9-	
			AUDI A3/S3 1,8 i TURBO 20V	1781 AJQ	G	M/A	*/-	96/9-	
			AUDI A3/S3 1,8 i TURBO 20V	1781 APP	G	M/A	*/-	96/9-	
			AUDI A3/S3 1,8 i TURBO 20V	1781 APY	G	M/A	*/-	96/9-	
			AUDI A3/S3 1,8 i TURBO 20V	1781 ARZ	G	M/A	*/-	96/9-	
			AUDI A3/S3 1,8 i TURBO 20V	1781 BAM	G	M/A	*/-	96/9-	
			AUDI TT 1,8 i TURBO 20V	1781 AJQ	G	M/A	*/-	98/10-	
			AUDI TT 1,8 i TURBO 20V	1781 BVP	G	M/A	*/-	98/10-	
			AUDI TT 1,8 i TURBO 20V	1781 APP	G	M/A	*/-	98/10-	
			AUDI TT 1,8 i TURBO 20V	1781 BVR	G	M/A	*/-	98/10-	
			AUDI TT 1,8 i TURBO 20V	1781 APX	G	M/A	*/-	98/10-	
			AUDI TT 1,8 i TURBO 20V	1781 ARY	G	M/A	*/-	98/10-	
			AUDI TT 1,8 i TURBO 20V	1781 AUM	G	M/A	*/-	98/10-	
			AUDI TT 1,8 i TURBO 20V	1781 AUQ	G	M/A	*/-	98/10-	
			AUDI TT 1,8 i TURBO 20V	1781 AUQ	G	M/A	*/-	98/10-	
			AUDI TT 1,8 i TURBO 20V	1781 BAM	G	M/A	*/-	98/10-	
			AUDI TT 1,8 i TURBO 20V	1781 BFV	G	M/A	*/-	98/10-	
			AUDI TT 3,2 V6	3189 BHE	G	M/A	*/-	98/10-	
			AUDI TT 3,2 V6	3189 BPF	G	M/A	*/-	98/10-	
			SEAT LEON 1,6 i	1595 AEH	G	M/A	*/-	98/11-02/5	
			SEAT LEON 1,8 20V	1781 AGN	G	M/A	*/-	98/10-03/12	
			SEAT LEON 1,8 20V	1781 APG	G	M/A	*/-	00/6-02/5	
			SEAT TOLEDO 1,6 i	1595 AEH	G	A	*	98/11-02/5	
			SEAT TOLEDO 1,8 i 20V	1781 AGN	G	M/A	*/-	98/10-03/12	
			SEAT TOLEDO 1,8 i 20V	1781 AGN	G	M/A	*/-	98/10-03/12	
			SEAT TOLEDO 1,8 i 20V	1781 APG	G	M/A	*/-	00/6-02/5	
			SEAT TOLEDO 1,8 i 20V	1781 APG	G	M/A	*/-	00/6-03/5	
			OCTAVIA 2,0 i	1984 AEG	G	M/A	*	00/8-	
			OCTAVIA 2,0 i	1984 APK	G	M/A	*	00/8-	
			OCTAVIA 2,0 i	1984 AQY	G	M/A	*	00/8-	
			OCTAVIA 2,0 i	1984 AZH	G	M/A	*	00/8-	
			OCTAVIA 2,0 i	1984 AZJ	G	M/A	*	00/8-	
			OCTAVIA 1,8i 20V TURBO	1781 AGU	G	M/A	*/-	99/4-	
			OCTAVIA 1,8i 20V TURBO	1781 ARX	G	M/A	*/-	99/4-	
			OCTAVIA 1,8i 20V TURBO	1781 AUM	G	M/A	*/-	99/4-	



№ФОРВАРДА	№ OEM	№ NISSENS	МОДЕЛЬ	ТИП ДВИГАТЕЛЯ	БЕН/Д ИЗ	ТИП КП	КОНД ИЦИ	ГОД	ПРИМЕЧА НИЕ
			OCTAVIA 1,8i 20V TURBO	1781 AUQ	G	M/A	*/-	99/4-	
			OCTAVIA 1,8i 20V TURBO	1781 ARZ	G	M/A	*/-	99/9-	
			BORA 1,6 i 8V	1595 AEH	G	A	*	98/9-01/4	
			BORA 1,6 i 8V	1595 AKL	G	A	*/-	98/9-01/4	
			BORA 1,6 i 8V	1595 APF	G	A	*/-	99/5-00/9	
			BORA 1,6 i 8V	1595 AVU	G	A	*/-	00/9-01/4	
			BORA 1,8 i 20V	1781 AGN	G	A	*/-	99/2-00/10	
			BORA 1,8 i 20V TURBO	1781 AGU	G	A	*/-	00/5-01/4	
			BORA 1,8 i 20V TURBO	1781 AUQ	G	A	*/-	02/5-	
			GOLF IV 1,6 i	1595 AEH	G	M/A	*	98/1-	
			GOLF IV 1,6 i	1595 AKL	G	M/A	*	97/10-	
			BORA 1,8 i 20V TURBO	1781 ARX	G	A	*/-	00/9-01/4	
			GOLF IV 1,6 i	1595 APF	G	M/A	*	99/5-	
			BORA 1,8 i 20V TURBO	1781 AUM	G	A	*/-	00/9-01/4	
			GOLF IV 1,6 i	1595 AVU	G	M/A	*	01/05-02	
			BORA 2,0i	1984 APK	G	A	*	98/11-01/4	
			GOLF IV 1,6 i	1595 BFQ	G	M/A	*	02/5-	
			BORA 2,0i	1984 AQY	G	A	*	98/9-01/4	
			BORA 2,0i	1984 AVH	G	A	*/-	01/2-01/4	
			GOLF IV 1,8 i 20V	1781 AGN	G	M/A	*/-	97/10-	
			BORA 2,0i	1984 AZS	G	A	*/-	01/2-01/4	
			BORA 2,0i	1984 AZN	G	A	*	00/4-01/4	
			GOLF IV 1,8 i 20V TURBO	1781 AGU	G	M/A	*/-	97/10-	
			BORA 2,3 i V5	2324 AGZ	G	A	*/-	98/9-01/2	
			GOLF IV 1,8 i 20V	1781 AUM	G	M/A	*/-	00/9-	
			BORA 2,3 i V5	2324 AQN	G	A	*/-	00/9-01/4	
			GOLF IV 2,0 i	1998 APK	G	M/A	*	98/8-	
			BORA 2,8 i V6	2792 AQP	G	A	*	99/9-00/5	
			GOLF IV 2,0 i	1998 AQY	G	M/A	*	98/8-	
			GOLF IV 2,0 i	1998 AZG	G	M/A	*	01/5-	
			BORA 2,8 i VR6	2792 AUE	G	A	*	00/5-01/4	
			GOLF IV 2,0 i	1998 AZH	G	M/A	*	98/8-	
			GOLF IV 2,0 i	1998 AZJ	G	M/A	*	01/5-	
			GOLF IV 2,0 i	1998 BEH	G	M/A	*	02/5-	
			GOLF IV 2,3 i V5	2324 AGZ	G	M/A	*/-	97/10-	
			GOLF IV 2,3 i V5	2324 AQN	G	M/A	*/-	00/9-	
			GOLF IV 2,8 i V6	2792 AQP	G	M/A	*/-	99/5-00/5	
			GOLF IV 2,8 i V6	2792 AUE	G	M/A	*/-	00/1-01/4	
			GOLF IV 2,8 i V6	2792 BDE	G	M/A	*/-	01/5-	
			GOLF IV 3,2 i V6	3198 BFH	G	M/A	*/-	02/6-	
			GOLF IV 3,2 i V6	3198 BML	G	M/A	*/-	03/10-	
AI0A401-930	8E0260403B	94583	AUDI A4 '01-03 [+A6 01-04] КОНДЕНСАТОР КОНДИЦ						605 401 16

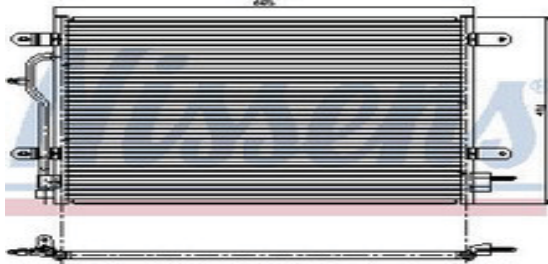

A4/S4 1,6 I 16V	ALZ	G	*	M	00/12-
A4/S4 1,8 TURBO 20V	AMB	G	*	M	01/7-
A4/S4 1,8 TURBO 20V	AMB	G	*	A	01/7-
A4/S4 1,8 TURBO 20V	AVJ	G	*	M	00/12-02/6
A4/S4 1,8 TURBO 20V	AVJ	G	*	A	00/12-02/6
A4/S4 1,8 TURBO 20V	BEX	G	*	M	02/11-
A4/S4 1,8 TURBO 20V	BEX	G	*	A	02/11-
A4/S4 1,8 TURBO 20V	BFB	G	*	M	02/7-03/5
A4/S4 1,8 TURBO 20V	BFB	G	*	A	02/7-03/5
A4/S4 2,0 TFSi	BGB	G	*	M	00/12-
A4/S4 2,0 TFSi	BGB	G	*	A	00/12-
A4/S4 2,0 i 16 V	ALT	G	*	M	00/12-
A4/S4 2,0 i 16 V	ALT	G	*	A	00/12
A4/S4 2,0 i 16 V	BRE	G	*	M	00/12
A4/S4 2,0 i 16 V	BRE	G	*	A	00/12

№ФОРВАРДА	№ OEM	№ NISSENS	МОДЕЛЬ	ТИП ДВИГАТЕЛЯ	БЕН/Д ИЗ	ТИП КП	КОНД ИЦИ	ГОД	ПРИМЕЧА НИЕ
		A4/S4 2,0 i 16 V		BRF	G	*	M	00/12	
		A4/S4 2,0 i 16 V		BRF	G	*	A	00/12	
		A4/S4 2,0 Fsi		AWA	G	*	M	02/7-	
		A4/S4 2,0 Fsi		AWA	G	*	A	02/7-	
		A4/S4 2,4 V6		AMM	G	*	M	01/9-03/5	
		A4/S4 2,4 V6		AMM	G	*	A	01/9-03/5	
		A4/S4 2,4 V6		BDV	G	*	M	01/9-03/5	
		A4/S4 2,4 V6		BDV	G	*	A	01/9-03/5	
		A4/S4 3,0 V6		ASN	G	*	M	00/12-03/5	
		A4/S4 3,0 V6		ASN	G	*	A	00/12-03/5	
		A4/S4 3,2 i V6		AUK	G	*	M	05/1-	
		A4/S4 3,2 i V6		AUK	G	*	A	05/1-	
		A4/S4 3,0 V6		AVK	G	*	A	01/9-02/6	
		A4/S4 3,0 V6		BBJ	G	*	M	01/4-03/5	
		A4/S4 3,0 V6		BBJ	G	*	A	01/4-03/5	
		A4/S4 1,9 Tdi		AVB	D	*	M	01/4-04/5	
		A4/S4 1,9 Tdi		AVF	D	*	M	01/4-	
		A4/S4 1,9 Tdi		AVF	D	*	A	01/4-	
		A4/S4 1,9 Tdi		AWX	D	*	M	00/12-03/6	
		A4/S4 2,5 Tdi		AKE	D	*	A	00/12-03/5	
		A4/S4 2,5 Tdi		AKE	D	*	A	00/12-03/5	
		A4/S4 2,5 Tdi		AYM	D	*	M	01/4-02/6	
		A4/S4 2,5 Tdi		AYM	D	*	A	01/4-02/6	
		A4/S4 2,5 Tdi		BFC	D	*	M	02/7-03/5	
		A4/S4 2,5 Tdi		BFC	D	*	A	02/07-03/5	
		A6/S6 2,0 E		1984 ALT	G	*	M	01/6-04/5	
		A6/S6 2,0 E		1984 ALT	G	*	A	01/6-04/5	
		A6/S6 3,0 E 30V		2976 ASN	G	*/-	M	01/6-04/5	
		A6/S6 3,0 E 30V		2976 ASN	G	*/-	A	01/6-04/5	
		A6/S6 3,0 E 30V		2976 BBJ	G	*/-	M	01/6-04/5	
		A6/S6 3,0 E 30V		2976 BBJ	G	*/-	A	01/6-04/5	
		A6 ALLROAD 4,2 V8		4172 BAS	G	*/-	A	03/4-	

A10A401-931	8E0260401D/403D	94665	AUDI A4 '01-'04 КОНДЕНСАТОР КОНДИЦ						605 401 16
--------------------	------------------------	--------------	---	--	--	--	--	--	-------------------

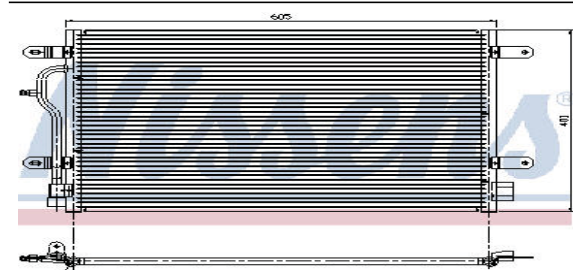

A 4 / S 4 1.6 i 16V	ALZ	G	M	+	12/00 -
A 4 / S 4 1.8 I 20V TURBO	AMB	G	M	+	07/01 -
A 4 / S 4 1.8 I 20V TURBO	AMB	G	A	+	07/01 -
A 4 / S 4 1.8 I 20V TURBO	BEX	G	M	+	11/02 -
A 4 / S 4 1.8 I 20V TURBO	BEX	G	A	+	11/02 -
A 4 / S 4 1.8 I 20V TURBO	BFB	G	M	+	07/02 - 05/03
A 4 / S 4 1.8 I 20V TURBO	BFB	G	A	+	07/02 - 05/03
A 4 / S 4 1.9 TDi	AVB	D	M	+	04/01 - 05/04
A 4 / S 4 1.9 TDi	AVF	D	M	+	04/01 -
A 4 / S 4 1.9 TDi	AVF	D	A	+	04/01 -
A 4 / S 4 1.9 TDi	AWX	D	M	+	12/00 - 06/03
A 4 / S 4 1.9 TDi	BKE/BRB	D	M	+	06/04 -
A 4 / S 4 2.0 FSi	AWA	G	M	+	07/02 -
A 4 / S 4 2.0 FSi	AWA	G	A	+	07/02 -
A 4 / S 4 2.0 I 16V	ALT/BRE/BRF	G	M	+	12/00 -
A 4 / S 4 2.0 I 16V	ALT/BRE/BRF	G	A	+	12/00 -

№ФОРВАРДА	№ OEM	№ NISSENS	МОДЕЛЬ	ТИП ДВИГАТЕЛЯ	БЕН/Д ИЗ	ТИП КП	КОНД ИЦИ	ГОД	ПРИМЕЧА НИЕ
			A 4 / S 4 2.0 PD TDi	BLB/BNA/BPW/BRD/BVA/BV	D	M	+	12/00 -	
			A 4 / S 4 2.0 PD TDi	BLB/BNA/BPW	D	A	+	12/00 -	
			A 4 / S 4 2.0 PD TDi	BRC/BRC/BRD/BVA/BVF	G	A	+	12/00 -	
			A 4 / S 4 2.0 TFSi	BGB/BPG/BPJ/BUL/BWE/BW	G	M	+	12/00 -	
			A 4 / S 4 2.0 TFSi	BGB/BPG/BPJ/BUL/BWE/BW	G	A	+	12/00 -	
			A 4 / S 4 2.4 i V6	AMM/BDV	G	M	+	09/01 - 05/03	
			A 4 / S 4 2.4 i V6	AMM/BDV	G	A	+	09/01 - 05/03	
			A 4 / S 4 2.5 TDi	AKE/AKE	D	A	+	12/00 - 05/03	
			A 4 / S 4 2.5 TDi	BAU/BCZ/BDG/BDH	D	A	+	06/03 -	
			A 4 / S 4 2.5 TDi	BAU/BCZ/BDG/BDH	D	M	+	06/03 -	
			A 4 / S 4 2.5 TDi	BFC	D	M	+	07/02 - 05/03	
			A 4 / S 4 2.5 TDi	BFC	D	A	+	07/02 - 05/03	
			A 4 / S 4 2.7 TDi	BPP/BSG	D	M/A	+	06/03 -	
			A 4 / S 4 3.0 i V6	ASN	G	M	+	12/00 - 05/03	
			A 4 / S 4 3.0 i V6	ASN	G	A	+	12/00 - 05/03	
			A 4 / S 4 3.0 i V6	BBJ	G	M	+	04/01 - 05/03	
			A 4 / S 4 3.0 i V6	BBJ	G	A	+	04/01 - 05/03	
			A 4 / S 4 3.0 TDi	ASB/BKN	D	M/A	+	06/03 -	
AI0A494-930	8DO260401A	94207	AUDI A4 '94-96 КОНДЕНСАТОР КОНДИЦ (NISSENS)						615 421 16
AI0A494-931	8DO260401A	94207	AUDI A4 '94-96 КОНДЕНСАТОР КОНДИЦ						615 421 16



A4 1,6i	1595 ADP	D	M	*	96/8-
A4 1,6i	1595 ADP	D	A	*/-	96/8-
A4 1,6i	1595 AHL	D	M	*	95/1-
A4 1,6i	1595 AHL	D	A	*/-	95/1-
A4 1,8 i 20V	1781 ADR	G	M	*	94/11-
A4 1,8 i 20V	1781 ADR	G	A	*/-	94/11-
A4 1,8 i 20V	1781 AFY	G	M	*	95/7-
A4 1,8 i 20V	1781 AFY	G	A	*/-	95/7-
A4 1,8 i TURBO 20V	1781 AEB	G	M	*	95/10-
A4 1,8 i TURBO 20V	1781 AEB	G	A	*/-	95/10-
A4 1,9 TDI	1896 AFF	D	M	*	96/3-
A4 1,9 TDI	1896 AFN	D	M	*	96/2-
A4 1,9 TDI	1896 AFN	D	A	*/-	96/2-
A4 1,9 TDI	1896AHH	D	M	*	97/4-
A4 1,9 TDI	1896 AHU	D	M	*	96/8-
A4 1,9 TDI	1896 AHU	D	A	*/-	96/8-
A4 1,9 TDI	1896 IZ	D	M	*	95/1-
A4 1,9 TDI	1896 IZ	D	A	*/-	95/1-
A4 2,4 i V6	2393 AFM	G	M	*/-	95/7-
A4 2,6 i V6	2598 ABC	G	M	*/-	94/11-
A4 2,6 i V6	2598 ABC	G	M	*/-	94/11-
A4 2,6 i V6	2598 ACZ	G	A	*/-	94/11-
A4 2,6 i V6	2598 ACZ	G	M	*/-	96/1-
A4 2,8 i V6	2771 AAH	G	A	*/-	96/1-
A4 2,8 i V6	2771 AHH	G	M	*/-	94/11-
A4 2,8 i V6	2771 ACK	G	M	*/-	96/3-
A4 2,8 i V6	2771 ACK	G	A	*/-	96/3-
A4 2,8 i V6	2771 ACK	G	M/A	*/-	96/3-

№ФОРВАРДА	№ OEM	№ NISSENS	МОДЕЛЬ	ТИП ДВИГАТЕЛЯ	БЕН/Д ИЗ	ТИП КП	КОНД ИЦИ	ГОД	ПРИМЕЧА НИЕ
A10A494-932	8D0260403E/H	94594	AUDI A4 '94-{'+ PASSAT 96- } КОНДЕНСАТОР КОНДИЦ						565 420 20
A10A497-931	8B0260403E/H	94594	AUDI A4 '97-00 КОНДЕНСАТОР КОНДИЦ						565 420 20

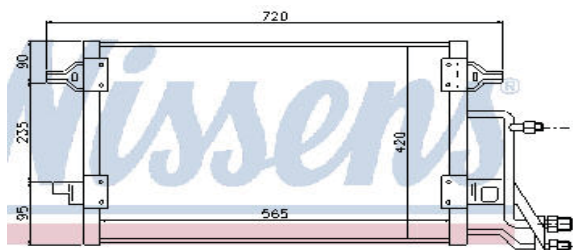

A4 / S 4 1.6i	ADP	G	M	+/-	11/94 -
A4 / S 4 1.6i	ADP	G	A	+/-	11/94 -
A4 / S 4 1.6i	AHL	G	M	+	10/96 -
A4 / S 4 1.6i	AHL	G	A	+/-	06/96 -
A4 / S 4 1.6i	ALZ	G	M	+	06/00 -
A4 / S 4 1.6i	ANA	G	M	+	08/98 -
A4 / S 4 1.6i	ANA/ARM	G	A	+/-	08/98 -
A4 / S 4 1.6i	ARM	G	M	+	08/98 -
A4 / S 4 1.8 i 20V	ADR	G	A	+/-	11/94 -
A4 / S 4 1.8 i 20V	ADR	G	M	+	11/94 -
A4 / S 4 1.8 i 20V	AFY	G	M	+	07/95 -
A4 / S 4 1.8 i 20V	AFY	G	A	+/-	07/95 -
A4 / S 4 1.8 i 20V	APT	G	M	+	04/99 -
A4 / S 4 1.8 i 20V	APT	G	A	+/-	04/99 -
A4 / S 4 1.8 i 20V	ARG	G	M	+	08/98 -
A4 / S 4 1.8 i 20V	ARG	G	A	+/-	08/98 -
A4 / S 4 1.8 i 20V	AVV	G	A	+/-	06/00 -
A4 / S 4 1.8 i 20V	AVV	G	M	+	06/00 -
A4 / S 4 1.8 i TURBO 20V	AEB	G	M	+	10/95 -
A4 / S 4 1.8 i TURBO 20V	AEB	G	A	+/-	10/95 -
A4 / S 4 1.8 i TURBO 20V	AJL	G	M	+	08/97 -
A4 / S 4 1.8 i TURBO 20V	ANB	G	M	+	01/99 -
A4 / S 4 1.8 i TURBO 20V	ANB	G	A	+/-	01/99 -
A4 / S 4 1.8 i TURBO 20V	APU	G	M	+	04/98 -
A4 / S 4 1.8 i TURBO 20V	APU	G	A	+/-	04/98 -
A4 / S 4 1.8 i TURBO 20V	ARK	G	M	+	08/98 -
A4 / S 4 1.8 i TURBO 20V	ARK	G	A	+/-	08/98 -
A4 / S 4 1.8 i TURBO 20V	AWT	G	M	+	06/00 -
A4 / S 4 1.8 i TURBO 20V	AWT	G	A	+	06/00 -
A4 / S 4 2.4 i V6	AFM	G	M	+/-	07/95 -
A4 / S 4 2.4 i V6	AGA/AJG/ALF	G	M	+/-	08/97 -
A4 / S 4 2.4 i V6	AGA/AJG/ALF	G	A	+/-	08/97 -
A4 / S 4 2.4 i V6	AML	G	A	+/-	08/98 -
A4 / S 4 2.4 i V6	AML	G	M	+/-	08/98 -
A4 / S 4 2.4 i V6	AMM	G	A	+/-	06/00 -
A4 / S 4 2.4 i V6	AMM	G	M	+/-	06/00 -
A4 / S 4 2.4 i V6	APS/APZ/ARJ	G	M	+/-	08/98 -
A4 / S 4 2.4 i V6	APS/APZ/ARJ	G	A	+/-	08/98 -
A4 / S 4 2.6 i V6	ABC	G	M	+/-	11/94 -
A4 / S 4 2.6 i V6	ABC	G	A	+/-	11/94 -
A4 / S 4 2.6 i V6	ACZ	G	M	+/-	01/96 -
A4 / S 4 2.6 i V6	ACZ	G	A	+/-	01/96 -
A4 / S 4 2.8 i V6	AAH	G	M	+/-	11/94 -
A4 / S 4 2.8 i V6	AAH	G	A	+/-	11/94 -
A4 / S 4 2.8 i V6	ACK	G	A	+/-	03/96 -
A4 / S 4 2.8 i V6	ACK	G	M	+/-	03/96 -
A4 / S 4 2.8 i V6	ALG	G	M	+/-	08/97 -
A4 / S 4 2.8 i V6	ALG	G	A	+/-	08/97 -
A4 / S 4 2.8 i V6	AMX/APR/AQD	G	M	+/-	08/98 -
A4 / S 4 2.8 i V6	AMX/APR/AQD	G	A	+/-	08/98 -

№ФОРВАРДА	№ OEM	№ NISSENS	МОДЕЛЬ	ТИП ДВИГАТЕЛЯ	БЕН/Д ИЗ	ТИП КП	КОНД ИЦИ	ГОД	ПРИМЕЧА НИЕ
		A 4 / S 4 2.8 i V6		ATX	G	M	+/-	03/99 -	
		A 4 / S 4 2.8 i V6		ATX	G	A	+/-	03/99 -	
		A 4 / S 4 1.9 TDi		AFN	D	M	+	02/96 -	
		A 4 / S 4 1.9 TDi		AFN	D	A	+/-	02/96 -	
		A 4 / S 4 1.9 TDi		AHH	D	M	+	04/97 -	
		A 4 / S 4 1.9 TDi		AHU	D	A	+/-	08/96 -	
		A 4 / S 4 1.9 TDi		AHU	D	M	+	08/96 -	
		A 4 / S 4 1.9 TDi		ATJ	D	A	+/-	01/00 -	
		A 4 / S 4 1.9 TDi		AVG	D	M	+	08/99 -	
		A 4 / S 4 1.9 TDi		AVG	D	A	+/-	08/99 -	
		A 4 / S 4 1.9 TDi		IZ	D	A	+/-	01/95 -	
		A 4 / S 4 1.9 TDi		IZ	D	M	+	01/95 -	
		PASSAT 1.6 i		ADP	G	M	+	01/97 - 10/97	
		PASSAT 1.6 i		ADP	G	A	+/-	01/97 - 10/97	
		PASSAT 1.6 i		AHL	G	M	+	10/96 - 08/00	
		PASSAT 1.6 i		AHL	G	A	+/-	10/96 - 08/00	
		PASSAT 1.6 i		ANA	G	M	+	07/99 - 08/00	
		PASSAT 1.6 i		ANA	G	A	+/-	07/99 - 08/00	
		PASSAT 1.6 i		ARM	G	M	+	01/99 - 08/00	
		PASSAT 1.8 i		ADR	G	A	+/-	12/96 - 01/99	
		PASSAT 1.8 i		ADR	G	M	+	12/96 - 01/99	
		PASSAT 1.8 i		AFY	G	M	+	01/97 - 04/00	
		PASSAT 1.8 i		AFY	G	A	+/-	01/97 - 04/00	
		PASSAT 1.8 i		APT	G	A	+/-	01/99 - 08/00	
		PASSAT 1.8 i		APT	G	M	+	01/99 - 08/00	
		PASSAT 1.8 i		ARG	G	A	+/-	02/99 - 08/00	
		PASSAT 1.8 i		ARG	G	M	+	02/99 - 08/00	
		PASSAT 1.8 i 20V TURBO		AEB	G	M	+	10/96 - 12/98	
		PASSAT 1.8 i 20V TURBO		AEB	G	A	+/-	10/96 - 12/98	
		PASSAT 1.8 i 20V TURBO		ANB	G	A	+/-	01/99 - 08/00	
		PASSAT 1.8 i 20V TURBO		ANB	G	M	+	01/99 - 08/00	
		PASSAT 1.8 i 20V TURBO		APU	G	M	+	01/99 - 08/00	
		PASSAT 1.8 i 20V TURBO		APU	G	A	+/-	01/99 - 08/00	
		PASSAT 1.9 TDi		AFN	D	A	+/-	10/96 - 08/99	
		PASSAT 1.9 TDi		AFN	D	M	+	03/96 - 08/99	
		PASSAT 1.9 TDi		AHH	D	M	+	05/98 - 08/00	
		PASSAT 1.9 TDi		AHH	D	A	+/-	05/98 - 08/00	
		PASSAT 1.9 TDi		AHU	D	M	+	10/96 - 08/00	
		PASSAT 1.9 TDi		AHU	D	A	+/-	10/96 - 08/00	
		PASSAT 1.9 TDi		AVG	D	M	+	08/99 - 08/00	
		PASSAT 1.9 TDi		AVG	D	A	+/-	08/99 - 08/00	
		PASSAT 2.3 i V5		AGZ	G	M	+/-	09/97 - 08/00	
		PASSAT 2.3 i V5		AGZ	G	A	+/-	09/97 - 08/00	
		PASSAT 2.8 i V6		ACK	G	M	+/-	06/97 - 12/98	
		PASSAT 2.8 i V6		ACK	G	A	+/-	06/97 - 12/98	
		PASSAT 2.8 i V6		AGE	G	M	+/-	05/97 - 09/99	
		PASSAT 2.8 i V6		AGE	G	A	+/-	05/97 - 09/99	
		PASSAT 2.8 i V6		ALG	G	M	+/-	06/97 - 08/00	
		PASSAT 2.8 i V6		ALG	G	A	+/-	06/97 - 08/00	
		PASSAT 2.8 i V6		APR	G	M	+/-	01/99 - 08/00	
		PASSAT 2.8 i V6		APR	G	A	+/-	01/99 - 08/00	
		PASSAT 2.8 i V6		AQD/ATX	G	M	+/-	09/99 - 08/00	
		PASSAT 2.8 i V6		AQD/ATX	G	A	+/-	09/99 - 08/00	

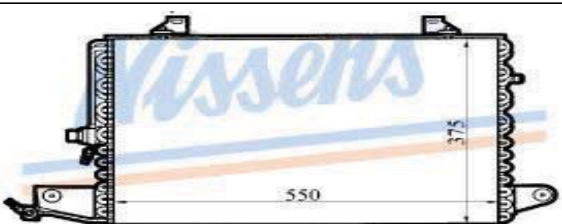
№ФОРВАРДА	№ OEM	№ NISSENS	МОДЕЛЬ	ТИП ДВИГАТЕЛЯ	БЕН/Д ИЗ	ТИП КП	КОНД ИЦИ	ГОД	ПРИМЕЧА НИЕ
AI0A694-930	4AO260403AC	94213	AUDI A6 '94-96 КОНДЕНСАТОР КОНДИЦ (NISSENS)						550 375 25
AI0A694-931	4AO260403AC	94213	AUDI A6 '94-96 КОНДЕНСАТОР КОНДИЦ						550 375 25
				100 1,6 i	1588ABB	G	M	*-/	92/3-94/7
				100 2,0E	1984ADD	G	M	*-/	90/12-92/12
				100 2,0E	1984ADD	G	A	*-/	90/12-92/12
				100 2,0E	1984AAE	G	M	*-/	90/12-94/7
				100 2,0E	1984ABK	G	M	*-/	93/1-94/7
				100 2,0E	1984ABK	G	A	*-/	93/1-94/7
				100 2,0E	1984ADW	G	M	*-/	93/12-94/7
				100 2,0E	1984ADW	G	A	*-/	93/12-94/7
				100 2,3E	2309AAR	G	M	*-/	90/12-94/7
				100 2,3E	2309AAR	G	A	*-/	90/12-94/7
				100 2,4D	2370AAS	D	M	*-/	90/12-94/7
				100 2,5TDI	2460AAT	D	M	*-/	90/12-94/7
				100 2,5TDI	2460AAT	D	A	*-/	90/12-94/7
				100 2,6E	2598ABC	G	M	*-/	92/3-94/7
				100 2,6E	2598ABC	G	A	*-/	92/3-94/7
				100 2,6E	2598ACZ	G	M	*-/	93/1-94/7
				100 2,6E	2598ACZ	G	A	*-/	93/1-94/7
				100 2,8E	2771AAH	G	M	*-/	92/1-94/7
				100 2,8E	2771AAH	G	A	*-/	92/1-94/7
				100 4,2E	4172ABH	G	M	*-/	92/10-94/7
				100 QUATTRO 2,0E	1994ADD	G	M	*-/	90/12-94/7
				100 QUATTRO 2,2 S4	2226AAN	G	M	*-/	91/8-94/7
				100 QUATTRO 2,2 SE	2226AAN	G	A	*-/	91/8-94/7
				100 QUATTRO 2,3E	2309AAR	G	M	*-/	90/12-94/7
				100 QUATTRO 2,6E	2598ABC	G	M	*-/	92/3-94/7
				100 QUATTRO 2,6E	2598ABC	G	A	*-/	92/3-94/7
				100 QUATTRO 2,6E	2598ACZ	G	M	*-/	93/1-94/7
				100 QUATTRO 2,6E	2598ACZ	G	A	*-/	93/1-94/7
				100 QUATTRO 2,8E	2771AAH	G	M	*-/	91/12-94/7
				100 QUATTRO 2,8E	2771AAH	G	A	*-/	90/12-94/7
100 QUATTRO 4,2E	4172ABH	G	M/A	*-/	92/10-94/7				
A6/S6 1,8 20V	1781ADR	G	M	*-/	95/10-96/6				
A6/S6 1,8 20V	1781ADR	G	M	*-/	96/7-97/10				
A6/S6 1,8 20V	1781ADR	G	A	*-/	95/10-96/6				
A6/S6 1,8 20V	1781ADR	G	A	*-/	96/7-97/10				
A6/S6 2,0i	1984AAE	G	M	*-/	94/6-97/10				
A6/S6 2,0i	1984AAE	G	A	*-/	94/6-97/10				
A6/S6 2,0i	1984ABK	G	M	*-/	94/6-97/10				
A6/S6 2,0i	1984ABK	G	A	*-/	94/6-97/10				
A6/S6 2,0i	1984ACE	G	M	*-/	94/6-97/10				
A6/S6 2,0i	1984ACE	G	M	*-/	94/6-97/10				
A6/S6 2,0i	1984ADW	G	M	*-/	96/7-97/10				
A6/S6 2,0i	1984 ADW	G	M	*-/	94/6-96/7				
A6/S6 2,0i	1984ADW	G	A	*-/	96/7-97/10				

№ФОРВАРДА	№ OEM	№ NISSENS	МОДЕЛЬ	ТИП ДВИГАТЕЛЯ	БЕН/Д ИЗ	ТИП КП	КОНД ИЦИ	ГОД	ПРИМЕЧА НИЕ
		A6/S6 2,0i		1984ADW	G	A	*/-	94/6-96/7	
		A6/S6 2,2i		2226AAN	G	M	*/-	96/7-97/7	
		A6/S6 2,2i		2226ANN	G	A	*/-	96/7-97/7	
		A6/S6 2,3 20V		AAR	G	M	*/-	94/6-96/6	
		A6/S6 2,3 20V		AAR	G	A	*/-	94/6-96/7	
		A6/S6 2,4 V6		2393AFM	G	A	*/-	95/7-96/6	
		A6/S6 2,5TDI		2460AAT	D	M	*/-	94/6-97/10	
		A6/S6 2,5TDI		2460ATT	D	A	*/-	94/6-97/10	
		A6/S6 2,5TDI		2460AEL	D	M	*/-	94/6-97/10	
		A6/S6 2,5TDI		2460AEL	D	A	*/-	94/6-97/10	
		A6/S6 2,6V6		2598ABC	G	M	*/-	94/6-96/6	
		A6/S6 2,6V6		2598ABC	G	M	*/-	96/7-97/10	
		A6/S6 2,6V6		2598ABC	G	A	*/-	94/6-96/6	
		A6/S6 2,6V6		2598ABC	G	A	*/-	96/7-97/10	
		A6/S6 2,6V6		2598ACZ	G	M	*/-	94/6-96/6	
		A6/S6 2,6V6		2598ACZ	G	M	*/-	96/7-97/10	
		A6/S6 2,6V6		2598ACZ	G	A	*/-	94/6-96/6	
		A6/S6 2,6V6		2598ACZ	G	A	*/-	96/7-97/10	
		A6/S6 2,8V6		2771AAH	G	M	*/-	94/6-96/6	
		A6/S6 2,8V6		2771AAH	G	M	*/-	96/7-97/10	
		A6/S6 2,8V6		2771AAH	G	A	*/-	94/6-96/6	
		A6/S6 2,8V6		2771AAH	G	A	*/-	96/7-97/10	
		A6/S6 2,8V6		2771ACK	G	M	*/-	94/6-97/10	
		A6/S6 2,8V6		2771ACK	G	A	*/-	94/6-97/10	
		A6/S6 2,8V6		2771AEJ	G	M	*/-	94/6-97/10	
		A6/S6 2,8V6		2771AEJ	G	A	*/-	94/6-97/10	
		A6/S6 4,2 V8		4172AEC	G	M/A	*/-	96/7-97/10	

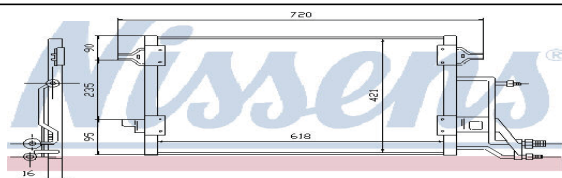

AI0A697-930 4B0260401F/T/S 94593 AUDI A6 '97- КОНДЕНСАТОР КОНДИЦ. (NISSENS) 618 421 16



AUDI A6 1,8 E 20V TURBO	1781AWT	G	*	A	01/6-04/5
AUDI A6 2,4 E 30V	2393AGA	G	*/-	A	4/97-1/99
AUDI A6 2,4 E 30V	2393AJG	G	*/-	A	4/97-1/99
AUDI A6 2,4 E 30V	2393ALF	G	*/-	A	6/97-1/99
AUDI A6 2,4 E 30V	2393ALW	G	*/-	A	8/97-1/99
AUDI A6 2,4 E 30V	2393AML	G	*/-	A	6/00-5/01
AUDI A6 2,4 E 30V	2393AMM	G	*/-	A	6/00-4/01
AUDI A6 2,4 E 30V	2393AMM	G	*/-	A	01/6-04/5
AUDI A6 2,4 E 30V	2393APC	G	*/-	A	4/98-4/01
AUDI A6 2,4 E 30V	2393APC	G	*/-	A	4/98-4/01
AUDI A6 2,4 E 30V	2393 APZ	G	*/-	A	11/98-00/5
AUDI A6 2,4 E 30V	2393 ARJ	G	*/-	A	11/98-01/4
AUDI A6 2,4 E 30V	2393 BDV	G	*/-	A	01/6-04/5
AUDI A6 2,7 E 30V	2393 ARE	G	*/-	A	01/6-02/3
AUDI A6 2,7 E 30V	2393ARE	G	*/-	A	01/6-02/3
AUDI A6 2,7 E 30V	2671 BES	G	*/-	A	02/7-04/5
AUDI A6 2,7 E 30V	2671 BES	G	*/-	A	02/7-04/5
AUDI A6 2,7 i V6	2671 ARE	G	*/-	M/A	00/5-
AUDI A6 2,7 i V6	2671 BES	G	*/-	M/A	00/5-
AUDI A6 2,8 E 30V	2771 ACK	G	*/-	A	97/4-99/1
AUDI A6 2,8 E 30V	2771 AGE	G	*/-	A	97/10-00/5
AUDI A6 2,8 E 30V	2771 ALG	G	*/-	A	97/6-99/1
AUDI A6 2,8 E 30V	2771 AMX	G	*/-	A	00/6-01/4
AUDI A6 2,8 E 30V	2771 APR	G	*/-	A	98/11-01/4
AUDI A6 2,8 E 30V	2771AQD	G	*/-	A	98/11-01/4
AUDI A6 2,8 E 30V	2771 ATX	G	*/-	A	99/7-01/4

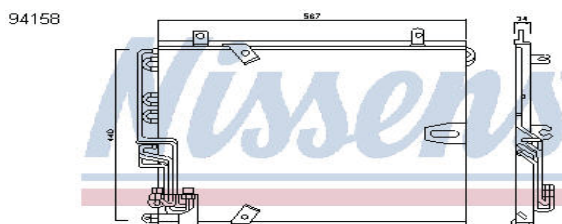

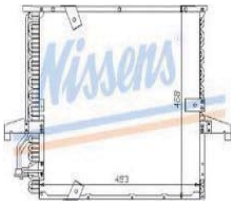
№ ФОРВАРДА	№ OEM	№ NISSENS	МОДЕЛЬ	ТИП ДВИГАТЕЛЯ	БЕН/Д ИЗ	ТИП КП	КОНД ИЦИ	ГОД	ПРИМЕЧА НИЕ
ВМ0Х500-930	6914216/8381543	94605	X5 '00- КОНДЕНСАТОР КОНДИЦ. (NISSENS)						540 391 16
			BMW X5 E 53 3,0 D	2926 M57	D	*/-	M	00/09-03/09	
			BMW X5 E 53 3,0 D	2926 M57	D	*/-	A	00/09-03/09	
			BMW X5 E 53 3,0 D	2926 M57N	D	*/-	M/A	04/10-	
			BMW X5 E 53 3,0i	2979	G	*/-	M	00/9-	
			BMW X5 E 53 3,0i	2979	G	*/-	A	00/9-	
			BMW X5 E 53 4 i	4398	G	*/-	A	00/9-	
			BMW X5 E 53 4 i	4398	G	*/-	A	03/10-	
			BMW X5 E 53 4,6i	4398	G	*/-	M/A	00/09-04/03	
			BMW X5 E 53 4,8i	4398	G	*/-	M/A	00/09-	

№ ФОРВАРДА	№ OEM	№ NISSENS	МОДЕЛЬ	ТИП ДВИГАТЕЛЯ	БЕН/Д ИЗ	ТИП КП	КОНД ИЦИ	ГОД	ПРИМЕЧА НИЕ
ВМЕ3487-930	6965952/8391316	94158	E34 '88- (+E32 (88-05/94)) КОНДЕНСАТОР КОНДИЦ						570 453 30
			5 E 34 (88-) 518 i	M40	G	M/A	+	01/88 - 05/94	
			5 E 34 (88-) 518 i	M43	G	M/A	+	01/88 - 11/95	
			5 E 34 (88-) 520 i	M20	G	A	+	06/87 - 06/88	
			5 E 34 (88-) 520 i	M20	G	M	+	06/87 - 11/95	
			5 E 34 (88-) 520 i	M20	G	A	+	06/88 - 11/95	
			5 E 34 (88-) 520 i	M50	G	M	+	09/89 - 11/95	
			5 E 34 (88-) 520 i	M50	G	A	+	09/89 - 09/92	
			5 E 34 (88-) 520 i	M50	G	A	+	09/92 - 11/95	
			5 E 34 (88-) 525 i	M20	G	A	+	06/87 - 06/88	
			5 E 34 (88-) 525 i	M20	G	M	+	06/87 - 08/90	
			5 E 34 (88-) 525 i	M20	G	A	+	06/88 - 08/90	
			5 E 34 (88-) 525 i	M50	G	M	+	01/89 - 11/95	
			5 E 34 (88-) 525 i	M50	G	A	+	01/89 - 09/92	
			5 E 34 (88-) 525 i	M50	G	A	+	09/92 - 11/95	
			5 E 34 (88-) 525 ix	M50	G	M	+	04/91 - 11/95	
			5 E 34 (88-) 525 ix	M50	G	A	+	04/91 - 09/92	
			5 E 34 (88-) 525 ix	M50	G	M	+	09/92 - 11/95	
			5 E 34 (88-) 525 ix	M50	G	A	+	09/92 - 11/95	
			5 E 34 (88-) 530 i	M30	G	M	+	06/87 - 08/91	
			5 E 34 (88-) 530 i	M30	G	A	+	06/87 - 08/91	
			5 E 34 (88-) 530 i	M60	G	A	+	03/92 - 09/93	
			5 E 34 (88-) 530 i	M60	G	M	+	03/92 - 06/94	
			5 E 34 (88-) 530 i	M60	G	M	+	06/94 - 11/95	
			5 E 34 (88-) 530 i	M60	G	A	+	09/93 - 11/95	
			5 E 34 (88-) 535 i	M30	G	M	+	03/87 - 12/93	
			5 E 34 (88-) 535 i	M30	G	A	+	03/87 - 12/93	
			5 E 34 (88-) 540 i	M60	G	A	+	09/92 - 11/95	
			5 E 34 (88-) 524 td	M21	D	M	+	07/87 - 11/95	
			5 E 34 (88-) 524 td	M21	D	A	+	07/87 - 11/95	
			5 E 34 (88-) 525 td	M51	D	M	+	04/93 - 11/95	
			7 E 32 (86-) 730 i	M30	G	A	+	07/86 - 07/94	

№ФОРВАРДА	№ OEM	№ NISSENS	МОДЕЛЬ	ТИП ДВИГАТЕЛЯ	БЕН/Д ИЗ	ТИП КП	КОНД ИЦИ	ГОД	ПРИМЕЧА НИЕ
		7 E 32 (86-) 730 i		M30	G	M	+	07/86 - 07/94	
		7 E 32 (86-) 735 i		M30	G	M	+	10/85 - 02/92	
		7 E 32 (86-) 735 i		M30	G	A	+	10/85 - 02/92	
		7 E 32 (86-) 735 i		M30	G	A	+	10/85 - 02/92	
		7 E 32 (86-) 735 iL		M30	G	M	+	10/85 - 02/92	
		7 E 32 (86-) 735 iL		M30	G	M	+	10/85 - 02/92	
		7 E 32 (86-) 735 iL		M30	G	A	+	10/85 - 02/92	
		7 E 32 (86-) 740 i		M60	G	M/A	+	06/90 - 05/94	
		7 E 32 (86-) 750 i		M70	G	A	+	09/86 - 05/94	
		7 E 32 (86-) 750 iL		M70	G	A	+	09/86 - 05/94	
		7 E 32 (86-) 730 i		M60	G	A	+	03/91 - 05/94	
		7 E 32 (86-) 730 iL		M60	G	M	+	03/91 - 05/94	
		7 E 32 (86-) 730 iL		M30	G	A	+	06/86 - 07/94	
		7 E 32 (86-) 730 iL		M30	G	M	+	06/86 - 07/94	
		7 E 32 (86-) 730 iL		M30	G	A	+	06/86 - 07/94	
		7 E 32 (86-) 730 iL		M30	G	M	+	06/86 - 07/94	
		7 E 32 (86-) 730 iL		M60	G	A	+	03/91 - 05/94	
		7 E 32 (86-) 730 iL		M60	G	M	+	03/91 - 05/94	
		7 E 32 (86-) 730 iL		M60	G	M	+	03/91 - 05/94	
		7 E 32 (86-) 730 iL		M60	G	M	+	03/91 - 05/94	
		7 E 32 (86-) 730 iL		M60	G	A	+	03/91 - 05/94	
ВМЕ3690-930	1385165	94166	Е36 '90-92 КОНДЕНСАТОР КОНДИЦ (NISSENS)						483 468 25
			E36 316 i M40	M40	G	A	*	11/90-9/92	
			E36 318 i M40	M40	G	A	*	11/90-9/92	
			E36 320 i M50	M50	G	A	*	11/90-9/92	
			E36 325 i	M50	G	A	*	11/89-9/92	
			E36 325 td	M50	D	A	*	11/90-9/92	
ВМЕ3692-930	8369105/391406/367946/390250	94157	Е36 '92-00 КОНДЕНСАТОР КОНДИЦ (NISSENS)						483 468 26
ВМЕ3692-931	8373004	94157	Е36 92-00 КОНДЕНСАТОР КОНДИЦ						483 468 26
			3 E36 316 i	M40	G	M	*	90/9-	
			3 E36 316 i	M40	G	A	*	90/9-	
			3 E36 316 i	M43	G	M	*	90/9-	
			3 E36 316 i	M43	G	A	*	90/9-	
			3 E36 318 i	M40	G	M	*	90/9-	
			3 E36 318 i	M40	G	A	*	9/92-95	
			3 E36 318 i	M43	G	M	*	90/9-	
			3 E36 318 is	M43	G	A	*	90/9-	
			3 E36 318 is	M42	G	M	*	90/9-	
			3 E36 318 is	M42	G	A	*	90/9-	
			3 E36 318 is	M44	G	M	*	90/9-	

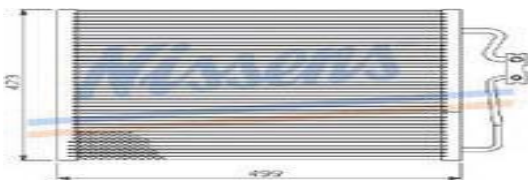
№ФОРВАРДА	№ OEM	№ NISSENS	МОДЕЛЬ	ТИП ДВИГАТЕЛЯ	БЕН/Д ИЗ	ТИП КП	КОНД ИЦИ	ГОД	ПРИМЕЧА НИЕ
		3 E36 318 is		M44	G	A	*	90/9-	
		3 E36 318 tds		M41	D	M	*	90/9-	
		3 E36 320 i		M50	G	M/A	*	92/9-	
		3 E36 320 i		M50	G	M/A	*	92/9-	
		3 E36 320 i		M50	G	M/A	*	92/9-	
		3 E36 320 i		M50	G	M	*	90/9-	
		3 E36 320 i		M50	G	A	*	92/9-	
		3 E36 320 i		M50	G	A	*	90/9-	
		3 E36 320 i		M52	G	M/A	*	90/9-	
		3 E36 320 i		M52	G	M/A	*	90/9-	
		3 E36 320 i		M52	G	M/A	*	90/9-	
		3 E36 323 i		M52	G	M/A	*	90/9-	JAPAN
		3 E36 323 i		M52	G	M/A	*	90/9-	AUS
		3 E36 323 i		M52	G	M/A	*	90/9-	TROPIC
		3 E36 323 i		M52	G	M	*	90/9-	
		3 E36 323 i		M52	G	A	*	90/9-	
		3 E36 325 i		M50	G	M/A	*	90/9-	
		3 E36 325 i		M50	G	M/A	*	90/9-	
		3 E36 325 i		M50	G	M/A	*	90/9-	
		3 E36 325 i		M50	G	M	*	90/9-	
		3 E36 325 i		M50	G	A	*	92/9-	
		3 E36 325 td		M51	D	M	*	90/9-	
		3 E36 325 td		M51	D	A	*	90/9-93/9	
		3 E36 325 td		M51	D	A	*	93/9-	
		3 E36 328 i		M52	G	M/A	*	90/9-	
		3 E36 328 i		M52	G	M/A	*	90/9-	
		3 E36 328 i		M52	G	M/A	*	90/9-	AUS
		3 E36 328 i		M52	G	M/A	*	90/9-	TROPIC
		3 E36 COMPACT 316g		M43	G	M	*	94/3-	
		3 E36 COMPACT 316i		M43	G	M	*	94/3	
		3 E36 COMPACT 316i		M43	G	A	*	94/3-	
		3 E36 COMPACT 318i		M42	G	M	*	94/3-	
		3 E36 COMPACT 318i		M42	G	A	*	94/3-	
		3 E36 COMPACT 318i		M44	G	M	*	94/3-	
		3 E36 COMPACT 318i		M44	G	A	*	94/3-	
		3 E36 COMPACT 318tds		M41	D	M	*	94/3-	
		3 E36 COMPACT 323 i		M52	G	M	*	94/3-	
ВМЕ3894-930	8373924/391126	94275	Е38 '94-97 КОНДЕНСАТОР КОНДИЦ (NISSENS)						498 427 16
ВМЕ3894-931	8373924/391126	94275	Е38 '94-97 КОНДЕНСАТОР КОНДИЦ						498 427 16
		7E 38 728i		M52	G	M/A	*/-	94/10-98/9	
		7E 38 728i		M60	G	M/A	*/-	94/10-	
		7E 38 728i		M62	G	M/A	*/-	94/1098/9	
		7E 38 728iL		M52	G	M/A	*/-	94/10-98/9	
		7E 38 728iL		M60	G	M/A	*/-	94/10	
		7E 38 735iL		M62	G	M/A	*/-	94/10-98/9	
		7E 38 740i		M62	G	M/A	*	94/10-98/9	
		7E 38 750i		M73	G	M/A	*	94/10-98/9	
		7E 38 750iL		M73	G	M/A	*	94/10-98/9	

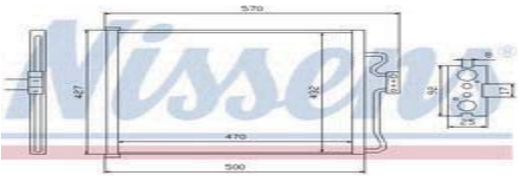
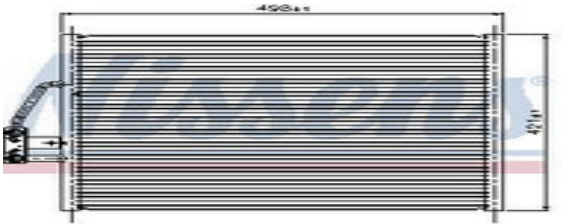

№ФОРВАРДА	№ OEM	№ NISSENS	МОДЕЛЬ	ТИП ДВИГАТЕЛЯ	БЕН/Д ИЗ	ТИП КП	КОНД ИЦИ	ГОД	ПРИМЕЧА НИЕ	
ВМЕ3897-930	8378439	94528	Е38 '97- КОНДЕНСАТОР КОНДИЦ (NISSENS)						470 432 25	
			7 E 38 728 i	M52	G	M/A	*/-	94/10-98/9		
			7 E 38 728 i	M52	G	M/A	*/-	98/9-		
			7 E 38 728 i	M62	G	M/A	*/-	94/10-98/9		
			7 E 38 728 IL	M52	G	M/A	*/-	98/9-		
			7 E 38 735 i	M62	G	M/A	*/-	98/9-		
			7 E 38 735 IL	M62	G	M/A	*/-	94/10-98/9		
			7 E 38 735 IL	M62	G	M/A	*/-	98/9-		
			7 E 38 735 IL	M62	G	M/A	*/-	98/9-		
			7 E 38 740 i	M62	G	M/A	*	94/10-98/9		
			7 E 38 740 i	M62	G	M/A	*	98/9-		
			7 E 38 740 i	M62	G	M/A	*	98/9-		
			7 E 38 750 i	M73	G	M/A	*	94/10-98/9		
			7 E 38 750 i	M73	G	M/A	*	98/9-		
			8 E 38 728 IL	M52	G	M/A	*/-	94/10-98/9		
			8 E 38 735 i	M62	G	M/A	*/-	98/9-		
7 E 38 750 IL	M73	G	M/A	*	94/10-98/9					
7 E 38 750 IL	M73	G	M/A	*	98/9-					
ВМЕ3998-930	8378438	94529	Е39 '98-03 КОНДЕНСАТОР КОНДИЦ						498 421 16	
			5E 39 520 i	M52	G	*	M/A	95/9-98/9		
			5E 39 520 i	M52	G	*	M/A	98/9-		
			5E 39 520 i	M52	G	*	M/A	95/9-98/9		
			5E 39 520 i	M54	G	*	M/A	98/9-		
			5E 39 523 i	M52	G	*	M/A	95/9-98/9		
			5E 39 523 i	M52	G	*	M/A	98/9-		
			5E 39 523 i	M52	G	*	M/A	95/9-98/9		
			5E 39 525 i	M52	G	*	M/A	98/9-		
			5E 39 528 i	M52	G	*	M/A	95/9-98/9		
			5E 39 528 i	M52	G	*	M/A	98/9-		
			5E 39 528 i	M52	G	*	M/A	95/9-98/9		
			5E 39 530 i	M52	G	*	M/A	98/9-		
			5E 39 535 i	M62	G	*	M/A	95/9-98/9		
			5E 39 535 i	M62	G	*	M/A	98/9-		
			5E 39 540 i	M62	G	*	M/A	95/9-98/9		
5E 39 540 i	M62	G	*	M/A	98/9-					
5E 39 540 i	M63	G	*	M/A	98/9-					
ВМЕ4698-930	8377614	94431	Е46 '98-04 КОНДЕНСАТОР КОНДИЦ						560 421 16	
ВМЕ4698-931	64538377614	94431	Е46 98-04 КОНДЕНСАТОР КОНДИЦ (NISSENS)						560 421 16	
			3 E 46 316 i		G	*	M	98/2-		
			3 E 46 318 i		G	*	M	98/2-		
			3 E 46 320 i		G	*	M	98/2-		
			3 E 46 323 i		G	*	M	98/2-		
			3 E 46 325 i		G	*	M/A	98/2-		
			3 E 46 328 i		G	*	M	98/2-		
			3 E 46 330 i		G	*	M/A	98/2-		
			3 E 46 M3		G	*	M	98/2-		
			3 E 46 СОМРАСТ 316 ti		G	*	M	01/6-		
			3 E 46 СОМРАСТ 318 ti	N42	G	*	M/A	01/6-		
			3 E 46 СОМРАСТ 318ti	N46	G	*	M	01/6-		
			3 E 46 СОМРАСТ 325 ti		G	*	M	01/6-		

№ФОРВАРДА	№ OEM	№ NISSENS	МОДЕЛЬ	ТИП ДВИГАТЕЛЯ	БЕН/Д ИЗ	ТИП КП	КОНД ИЦИ	ГОД	ПРИМЕЧА НИЕ
CNXSA97-930	6455AV/V9	94313	XSARA '97-00 КОНДЕНСАТОР КОНДИЦ						580 341 16
			XSARA 1,4 i	1360 TU3JP	G	M	*	97/9-98/10	
			XSARA 1,4 i	1360 TU3JP	G	M	*	98/8-00/8	
			XSARA 1,6 i	1587 TU5JP	G	M	*	97/9-98/10	
			XSARA 1,6 i	1587 TU5JP	G	M	*	98/8-00/8	
			XSARA 1,8 i	1761 XU7JB	G	M	*/-	97/9-98/10	
			XSARA 1,8 i	1761 XU7JB	G	M	*/-	98/8-00/8	
			XSARA 1,8 i	1761 XU7JB	G	A	*/-	97/9-98/9	
			XSARA 1,8 i	1761 XU7JB	G	A	*/-	97/12-98/10	
			XSARA 1,8 i	1761 XU7JB	G	A	*/-	98/10-00/8	
			XSARA 1,8 i 16V	1762 XU7JP4	G	M	*/-	97/9-98/10	
			XSARA 1,8 i 16V	1762 XU7JP4	G	M	*/-	98/8-00/8	
			XSARA 1,8 i 16V	1762 XU7JP4	G	A	*/-	97/9-98/9	
			XSARA 2,0 i 16V	1998 XU10J4R	G	M	*/-	98/1-98/10	
			XSARA 2,0 i 16V	1998 XU10J4R	G	M	*/-	98/9-00/8	
			XSARA 2,0 i 16V	1998 XU10J4RS	G	M	*/-	98/1-98/10	
			XSARA 2,0 i 16V	1998 XU10J4RS	G	M	*/-	98/9-00/8	
			306 1,4 i	1360 TU3JP	G	M	*	97/4-98/10	
			306 1,4 i	1360 TU3JP	G	M	*	98/11-	
			306 1,4 i	1360 TU3JP	G	A	*	96/0-	
			306 1,6 i	1587 TU7JP	G	M	*	98/11-	
		306 1,8 i	1762 XU7JP	G	M	*/-	97/4-98/10		
		306 1,8 i	1762 XU7JP	G	M	*/-	98/11-		
		306 1,8 i	1762 XU7JP	G	A	*/-	97/4-98/10		
		306 1,8 i	1762 XU7JP	G	A	*/-	98/11-		
		306 1,8 i 16V	1762 XU7JP4	G	M	*/-	97/4-98/10		
		306 1,8 i 16V	1762 XU7JP4	G	M	*/-	98/11-		
		306 2,0 GTI	1998 XU10J4RS	G	M	*/-	97/4-98/10		
		306 2,0 GTI	1998 XU10J4RS	G	M	*/-	97/4-98/10		
		306 2,0 i 16V	1998 XU10J4R	G	M	*/-	97/4-98/10		
		306 2,0 i 16V	1998 XU10J4R	G	M	*/-	98/11-		
		306 2,0 i 16V	1998 XU10J4R	G	A	*/-	97/4-98/10		
		306 2,0 i 16V	1998 XU10J4R	G	A	*/-	98/11-		

CRSTR95-930	4883536/5011395AB	94264	STRATUS '95-00 КОНДЕНСАТОР КОНДИЦ						670 378 22
			CIRRUS 2,0 i	2,00	G	*/-	M/A	95/2-	
			SEBRING CABRIO 2,0i	2,00	G	*/-	M/A	95/2-	
			STRATUS 2,0 i	2,00	G	*/-	M/A	95/2-	
			STRATUS 2,0 i	2,00	G	*/-	M/A	95/2-	
			BREEZE 2,0 i	2,00	G	*/-	M/A	95/2-	

№ФОРВАРДА	№ OEM	№ NISSENS	МОДЕЛЬ	ТИП ДВИГАТЕЛЯ	БЕН/Д ИЗ	ТИП КП	КОНД ИЦИ	ГОД	ПРИМЕЧА НИЕ
FDFOC98-930	1062380/11129663/1136949	94432	FOCUS '98- КОНДЕНСАТОР КОНДИЦ. (NISSENS)						668 361 16
FDFOC98-931	1062380/11129663/1136949	94432	FOCUS '98- КОНДЕНСАТОР КОНДИЦ.						668 361 16

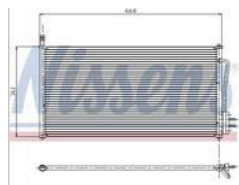

FOCUS 1,4 EFI	1388ZH14	G	*	M	8/98-
FOCUS 1,6 EFI	1596ZH16	G	*	M	8/98-
FOCUS 1,6 EFI	1596ZH16	G	*/-	A	8/98-
FOCUS 1,8 EFI	1796ZH18	G	*/-	M	8/98-
FOCUS 1,8 TD	1753LD18	D	*/-	M	99/1-
FOCUS 1,8 TDCi	1753FFDA	D	*/-	M	01.окт
FOCUS 1,8 TDCi	1753BHDA	D	*/-	M	98/8-
FOCUS 1,8 TDCi	1753BHDB	D	*/-	M	98/8
FOCUS 2,0 EFI	1988ZH20	G	*/-	M	8/98-
FOCUS 2,0 EFI	1988ZH20	G	*/-	A	8/98-
FOCUS ST 170		G	*/-	M	00/6-
FOCUS ST200		G	*/-	M	99/8-

FDMON93-930	1022447/7012068/93BW19710AG	94189	MONDEO '93-96 КОНДЕНСАТОР КОНДИЦ (NISSENS)						593 400 26
FDMON93-931	1022447/7012068/93BW19710AG	94189	MONDEO '93-96 КОНДЕНСАТОР КОНДИЦ						593 400 26



MONDEO 1,6 i 16V	1598ZH16	G	A	*/-	92/11-96/8
MONDEO 1,8 i 16V	1796ZH18	G	A	*/-	92/11-96/8
MONDEO 2,0 i 16V	1988ZH20	G	A	*/-	92/11-96/8
MONDEO 2,5 i V6 24V	2544MP25	G	A	*/-	92/11-96/8

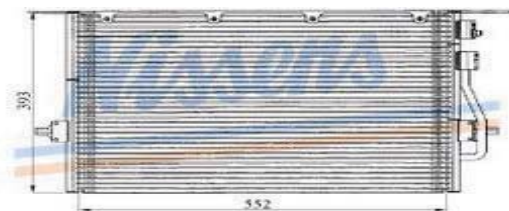

FDMON97-930	1022553/55189/60440/97BW19710BA/B	94308	MONDEO '97-99 (COUGAR 99-) КОНДЕНСАТОР КОНДИЦ (NISSENS)						584 385 16
--------------------	--	--------------	--	--	--	--	--	--	-------------------

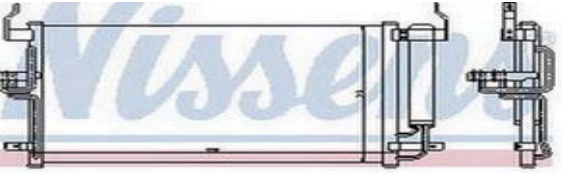
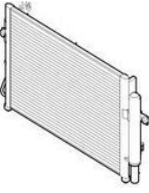
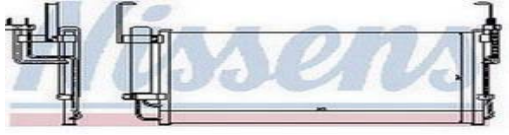
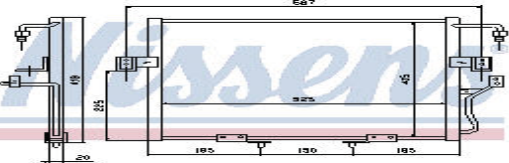

COUGAR 2,0 i 16V	1988ZH20	G	A	*/-	98/8-
COUGAR 2,5 Efi V6 24V	2544MP25	G	A	*/-	98/8
MONDEO 1,6 i 16V	1598ZH16	G	A	*/-	98/10-00/9
MONDEO 1,8 i 16V	1796ZH18	G	A	*/-	98/10-00/9
MONDEO 2,0 i 16V	1988ZH20	G	A	*/-	98/10-00/9
MONDEO 2,5 i V6 24V	2544MP25	G	A	*/-	97/11-00/9

№ФОРВАРДА	№ OEM	№ NISSENS	МОДЕЛЬ	ТИП ДВИГАТЕЛЯ	БЕН/Д ИЗ	ТИП КП	КОНД ИЦИ	ГОД	ПРИМЕЧА НИЕ
FDMON00-930	1152429/1232915/1311098/1348012	94586	MONDEO 00- {670x361mm} КОНДЕНСАТОР КОНДИЦ (NISSENS)						670 361 16
	MONDEO 1.8 i 16V	CGBA/CGBB	G	M/A	+/-	10/00 -			
	MONDEO 2.0 i 16V	CJBA/CGBB	G	M/A	+/-	10/00 -			
	MONDEO 2.0 TDCi		D	M/A	+/-	10/00 - 05/02			
	MONDEO 2.0 TDCi		D	M/A	+/-	05/02 - 05/03			
	MONDEO 2.0 TDCi		D	M/A	+/-	10/00 - 05/02			
	MONDEO 2.0 TDCi		D	M/A	+/-	05/02 - 05/03			
	MONDEO 2.5 i V6 24V	LCBD	G	M/A	+/-	10/00 -			
	MONDEO 2.5 i V6 24V	REBA	G	M/A	+/-	05/02 -			
	MONDEO ST 220	MEBA	G	M/A	+/-	05/02 -			
FDSCR86-930	1018361/93GW19710BC/BD	94271	SCORPIO '86-98 КОНДЕНСАТОР КОНДИЦ						510 415 26
	GRANADA 2,0 TWIN CAM	1998 DH20	G	A	*/-	89/9-92/2			
	GRANADA 2,0 i	1993 TL20	G	A	*/-	85/3-89/9			
	GRANADA 2,0 TWIN CAM	1998 DH20	G	A	*/-	89/9-92/2			
	GRANADA 2,4 i	2394 TV24	G	A	*/-	86/2-92/2			
	GRANADA 2,9 EFI V6	2933 TV29	G	A	*/-	86/2-92/2			
	SCORPIO CE 2,0	1993 TL20	G	A	*/-	85/3-89/9			
	SCORPIO CE 2,0 TWIN CAM	1998 DH20	G	A	*/-	89/9-92/2			
	SCORPIO CE 2,0 iTWIN CAM	1998 DH20	G	A	*/-	89/9-92/2			
	SCORPIO CE 2,4i	2394 TV24	G	A	*/-	86/2-92/2			
	SCORPIO CE 2,9 EFI V6	2933 TV29	G	A	*/-	86/2-92/2			
	SCORPIO DE 2,0 EFI	1998DH20	G	A	*/-	92/10-94/10			
	SCORPIO DE 2,4 i	2394 TV24	G	A	*/-	92/10-94/10			
	SCORPIO DE 2,9 EFI V6	2933 TV29	G	A	*/-	92/10-94/10			
	SCORPIO FE 2,0 Efi	1998 DL20	G	A	*	94/10-98/7			
SCORPIO FE 2,3 i	2295 DH23	G	A	*	94/10-98/7				
SCORPIO FE 2,9 Efi V6	2933 TV29	G	M/A	*	94/10-98/7				
SCORPIO FE 2,9 V6 COSWORTH	2935 CP29	G	M/A	*	94/10-				
HDCVC93-931	80110SR1A23/A13/023	94289	CIVIC '93-95 КОНДЕНСАТОР КОНДИЦ (NISSENS)						344 342 16
	CIVIC 1,3 i	D15B2	G	M	*/-	11/91-9/95			
	CIVIC 1,5 i	D15B2	G	M	*/-	11/91-9/95			
	CIVIC 1,5 i	D15B2	G	A	*/-	91/11-			
	CIVIC 1,5 i	D15Z6	G	M	*/-	11/91-			
	CIVIC 1,5 i	D15Z7	G	A	*/-	11/91-			
	CIVIC 1,6 Vti	D16A	G	M	*/-	11/91-9/95			
	CIVIC 1,6 Vti	D16A	G	A	*/-	8/91-9/95-			
HDCRV02-930	80101SCAA01/S9A003	94772	CR-V '02- КОНДЕНСАТОР КОНДИЦ						
	CR-V 2,4 i 16V	K24A	G	A	*/-	02/7-			

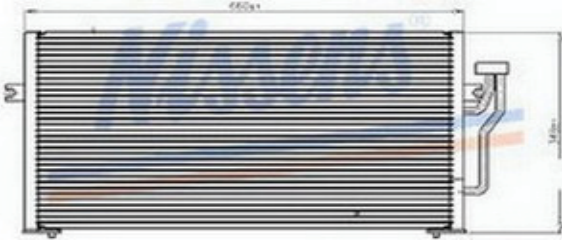
№ФОРВАРДА	№ OEM	№ NISSENS	МОДЕЛЬ	ТИП ДВИГАТЕЛЯ	БЕН/Д ИЗ	ТИП КП	КОНД ИЦИ	ГОД	ПРИМЕЧА НИЕ
HNELA00-930	976062D500	94448	ELANTRA '00- КОНДЕНСАТОР КОНДИЦ (NISSENS)						600 346 17
			ELANTRA 1,6i	1599	G	*/-	M	00/04-	
			ELANTRA 1,6i	1599	G	*/-	A	00/04-	
			ELANTRA 2,0 CDRi		D	*/-	M	00/04-	
			ELANTRA 2,0 CDRi		D	*/-	A	00/04-	
			ELANTRA 2,0 i	1975	G	*/-	M	00/04-	
			ELANTRA 2,0 i	1975	G	*/-	A	00/04-	
			LANTRA 1,5 I	1495	G	*/-	M	00/04-	
			LANTRA 1,5 I	1495	G	*/-	A	00/04-	
			LANTRA 1,6 i 16V	1599	G	*/-	M	00/04-	
			LANTRA 1,6 i 16V	1599	G	*/-	A	00/04-	
		LANTRA 2,0 i 16V	1975	G	*/-	M	00/04-		
		LANTRA 2,0 i 16V	1975	G	*/-	A	00/04-		
HNGEZ02-930	976061C200	94647	GETZ '02- КОНДЕНСАТОР КОНДИЦ (NISSENS)						503 350 18
			GETZ 1,1i	1086	G	*/-	M	02/09-	
			GETZ 1,3i	1341	G	*/-	M	02/09-	
			GETZ 1,4i	1399	G	*/-	M	02/09-	
			GETZ 1,6i	1594	G	*/-	M	02/09-	
HNSFE00-930	9760626000	94451	SANTA FE '00- КОНДЕНСАТОР КОНДИЦ (NISSENS)						630 345 20
			SANTA FE 2,0 CDRi	1991	D	*/-	M	00/6-	
			SANTA FE 2,0 CDRi	1991	D	*/-	A	00/6-	
			SANTA FE 2,0 i 16V	1975	G	*/-	M	00/6-	
			SANTA FE 2,4 i 16V	2351	G	*/-	M	00/6-	
			SANTA FE 2,4 i 16V	2351	G	*/-	A	00/6-	
			SANTA FE 2,7 i V6	2656	G	*/-	M	00/6-	
		SANTA FE 2,7 i V6	2656	G	*/-	A	00/6-		
KASPR94-930	0K01161480C/D/G/L	94416	SPORTAGE 94-97 КОНДЕНСАТОР КОНДИЦ 2 (NISSENS)						480 395 20
			CUTBACK 2.0 i 16V		G	M	+/-	00/00 -	
			CUTBACK 2.0 i 16V		G	A	+/-	00/00 -	
			SPORTAGE 2.0 i 16V	FE	G	M	+/-	09/93 -	
			SPORTAGE 2.0 i 16V	FE	G	A	+/-	09/93 -	
			SPORTAGE 2.0 TD	RF	D	M	+/-	09/93 -	

№ФОРВАРДА	№ OEM	№ NISSENS	МОДЕЛЬ	ТИП ДВИГАТЕЛЯ	БЕН/Д ИЗ	ТИП КП	КОНД ИЦИ	ГОД	ПРИМЕЧА НИЕ
МBCAR95-930	MB958166/MR460269	94433	CARISMA '95-04 КОНДЕНСАТОР КОНДИЦ (NISSENS)						660 348 16
			CARISMA 1,6 i 16V	4G92	G	A	*/-	95/6-	
			CARISMA 1,8 i 16V	4G93	G	A	*/-	95/5-	
			SPACE STAR 1,3 i 16V	4G13	G	A	*/-	98/9-	
			SPACE STAR 1,6 i 16V	4G16	G	A	*/-	98/9-	
			SPACE STAR 1,8 i 16V	4G18	G	A	*/-	98/9-	
			SPACE STAR 1,8 i 16V	4G93	G	A	*/-	98/9-	
									
МВGAL93-930	MB813733MR116930MR239950	94183	GALANT '93-96 КОНДЕНСАТОР КОНДИЦ (NISSENS)						630 330 26
МВLAN92-931	MR116930/MR239950	94183	LANCER '93-96 {COLT 92-96} КОНДЕНСАТОР КОНДИЦ						630 330 26
			GALANT (93-) 1.8 i 16V	4G93	G	A	+/-	01/93 - 12/96	
			GALANT (93-) 1.8 i 16V	4G93	G	M	+/-	01/93 - 12/96	
			GALANT (93-) 2.0 i 16V	4G93	G	M	+/-	01/93 - 12/96	
			GALANT (93-) 2.0 i 16V	4G93	G	A	+/-	01/93 - 12/96	
			GALANT (93-) 2.0 i V6 24V	6A12	G	M	+/-	01/93 - 12/96	
			GALANT (93-) 2.0 i V6 24V	6A12	G	A	+/-	01/93 - 12/96	
			GALANT (93-) 2.5 i V6 24V	6G73	G	M	+/-	01/93 - 12/96	
			GALANT (93-) 2.5 i V6 24V	6G73	G	A	+/-	01/93 - 12/96	
			GALANT (93-) 2.0 TD	4D68T	D	M	+/-	01/93 - 12/96	
			SPACE WAGON (92-) 2.0 i 16V	4G63	G	A	+/-	06/93 - 00/00	
			SPACE WAGON (92-) 2.0 i 16V	4G63	G	M	+/-	06/93 - 00/00	
			SPACE WAGON (92-) 2.0 TD	4D68T	D	M	+/-	06/92 - 00/00	
									
МВLAN96-930	MR218428	94357	LANCER '96-02 {COLT} КОНДЕНСАТОР КОНДИЦ (NISSENS)						658 312 20
			COLT 1,3 i 12V	4G13	G	M	*/-	3/96-	
			COLT 1,5 i 16V	4G13	G	M	*/-	3/96-	
			COLT 1,6i 16V	4G92	G	M	*/-	95/8-	
			LANCER 1,3 i 12V	4G13	G	M	*/-	96/1-	
			LANCER 1,5 i 16V	4G13	G	M	*/-	96/1-	
			LANCER 1,6 i 16V	4G92	G	M	*/-	96/1-	
									

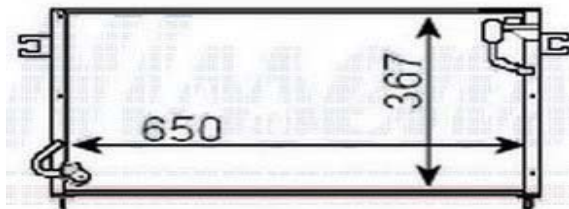

№ФОРВАРДА	№ OEM	№ NISSENS	МОДЕЛЬ	ТИП ДВИГАТЕЛЯ	БЕН/Д ИЗ	ТИП КП	КОНД ИЦИ	ГОД	ПРИМЕЧА НИЕ
МВРАЈ91-930	МВ918436/37	94784	РАЈЕРО '91- КОНДЕНСАТОР КОНДИЦ						
			РАЈЕРО 3,5 l V6 24V	6G74	G	М/А	*/-	94/5-	650 367 22

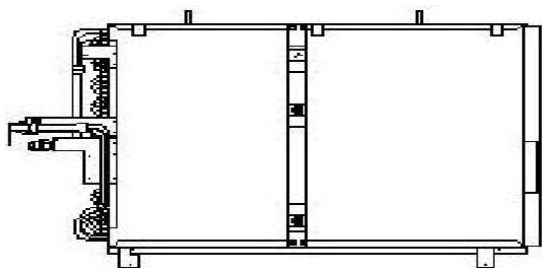

MD12483-930	1248301670	94377	W124 '83-94 КОНДЕНСАТОР КОНДИЦ (NISSENS)						540 428 26
MD12483-931		94377	W124 '83-94 КОНДЕНСАТОР КОНДИЦ (NISSENS)						540 428 26

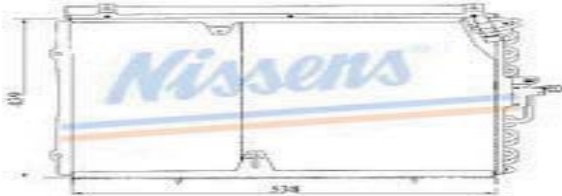

E-CLASS W 124 (84-) 260 E	M 103	G	M	+	09/84 - 06/93
E-CLASS W 124 (84-) 260 E	M 103	G	A	+	09/84 - 06/93
E-CLASS W 124 (84-) 260 E 4 MATIC	M 103	G	M	+	09/84 - 06/93
E-CLASS W 124 (84-) 260 E 4 MATIC	M 103	G	A	+	09/84 - 06/93
E-CLASS W 124 (84-) 280 E	M 104	G	M	+	08/92 - 06/93
E-CLASS W 124 (84-) 280 E	M 104	G	A	+	08/92 - 06/93
E-CLASS W 124 (84-) 300 CE	M 103	G	M	+	09/84 - 06/93
E-CLASS W 124 (84-) 300 CE	M 103	G	A	+	09/84 - 06/93
E-CLASS W 124 (84-) 300 E	M 103	G	M	+	09/84 - 06/93
E-CLASS W 124 (84-) 300 E	M 103	G	A	+	09/84 - 06/93
E-CLASS W 124 (84-) 300 E 24V	M 104	G	A	+	09/89 - 06/93
E-CLASS W 124 (84-) 300 E 24V	M 104	G	M	+	09/89 - 06/93
E-CLASS W 124 (84-) 300 E 4 MATIC	M 103	G	M	+	09/84 - 06/93
E-CLASS W 124 (84-) 300 E 4 MATIC	M 103	G	A	+	09/84 - 06/93
E-CLASS W 124 (84-) 300 E CABRIO	M 104	G	M	+	05/92 - 06/93
E-CLASS W 124 (84-) 300 E CABRIO	M 104	G	A	+	05/92 - 06/93
E-CLASS W 124 (84-) 320 CE	M 104	G	M/A	+	10/92 - 06/93
E-CLASS W 124 (84-) 320 E	M 104	G	M/A	+	10/92 - 06/93
E-CLASS W 124 (84-) 320 TE	M 104	G	M/A	+	10/92 - 06/93
E-CLASS W 124 (84-) E 280	M104	G	M	+	08/92 - 06/95
E-CLASS W 124 (84-) E 280	M104	G	A	+	08/92 - 06/95
E-CLASS W 124 (84-) E 320	M104	G	M	+	06/93 - 06/95
E-CLASS W 124 (84-) E 320	M104	G	A	+	06/93 - 06/95
E-CLASS W 124 (84-) E 320 4 MATIC	M104	G	M/A	+	06/93 - 06/95
E-CLASS W 124 (84-) E 320 CABRIO	M104	G	M/A	+	06/93 - 06/95
E-CLASS W 124 (84-) E 320 COUPE	M104	G	M/A	+	06/93 - 06/95
E-CLASS W 124 (84-) E 250 TD	OM 602	D	M	+/-	07/93 - 06/95
E-CLASS W 124 (84-) E 250 TD	OM 602	D	A	+/-	07/93 - 06/95
E-CLASS W 124 (84-) E 300 TD	OM 603	D	M/A	+	06/93 - 06/95

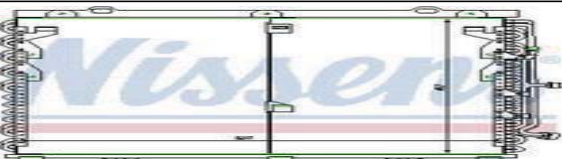
№ФОРВАРДА	№ OEM	№ NISSENS	МОДЕЛЬ	ТИП ДВИГАТЕЛЯ	БЕН/Д ИЗ	ТИП КП	КОНД ИЦИ	ГОД	ПРИМЕЧА НИЕ
MD12484-930	1248301070/1770	94162	W124 '84-95 КОНДЕНСАТОР КОНДИЦ (NISSENS)						538 439 26
			W124 200E	1996 M102	G	M	*	84/9-92/8	
			W124 230CE	2298M102	G	M	*	94/9-92/8	
			W124 230E	2298M102	G	M	*	84/9-92/8	
MD14091-930	1408300570	94330	W140 '91-92 КОНДЕНСАТОР КОНДИЦ					600 460 25	
			S-CLASS W 140 300 SE/SEL	M104990	G	M/A	*/-	91/2-92/12	
			S-CLASS W 140 300 SE/SEL	M104990	G	M/A	*/-	92/12-	
			S-CLASS W 140 300 SE/SEL	M104994	G	M/A	*/-	91/7-92/12	
			S-CLASS W 140 300 SE/SEL	M140994	G	M/A	*/-	92/12-	
MD14093-930	1408300070/0170/0670/0870	94270	W140 '93- КОНДЕНСАТОР КОНДИЦ					600 457 22	
			S-CLASS W140 S 280	M104944	G	M/A	*/-	93/5-	
			S-CLASS W140 S 320	M104990	G	M/A	*/-	93/7-	

№ФОРВАРДА	№ OEM	№ NISSENS	МОДЕЛЬ	ТИП ДВИГАТЕЛЯ	БЕН/Д ИЗ	ТИП КП	КОНД ИЦИ	ГОД	ПРИМЕЧА НИЕ
MD20182-930	2018302970/94314	94314	W201 82- КОНДЕНСАТОР КОНДИЦ						520 390 30
			190 W 201 (82-) 190 D 2.5	OM 602	D	A	+/-	05/85 - 08/93	
			190 W 201 (82-) 190 D 2.5	OM 602	D	M/A	+/-	05/85 - 08/93	
			C-CLASS W 201 (82-) 190 D 2.5	OM 602	D	A	+/-	05/85 - 08/93	
			C-CLASS W 201 (82-) 190 D 2.5	OM 602	D	M/A	+/-	05/85 - 08/93	

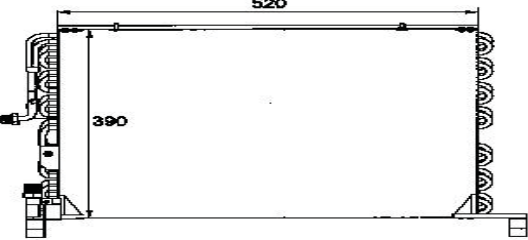

MD20293-930	2028300870	94284	W202 '93-00 КОНДЕНСАТОР КОНДИЦ (NISSENS)						
MD20293-931	2028300870	94284	W202 '93-00 КОНДЕНСАТОР КОНДИЦ						
			W202 C 200D	1997OM604	D	MA	*	10/96-5/00	
			W202 C 220D	2197OM604	D	MA	*	8/93-5/00	
			W202 C 240	2398M112.910	G	MA	*	6/97-5/00	
			W202 C 280	2799M104.941	G	MA	*	5/93-5/00	
			W202 C 280	2799M112.920	G	MA	*	6/97-5/00	
			W202 C 36 AMG	3606M104.941	G	MA	*	5/94-5/00	
			W202 C 43 AMG	4266M113.944	G	MA	*	8/97-5/00	
			W208 CLK 320	3199M112.940	G	M	*	3/97-	

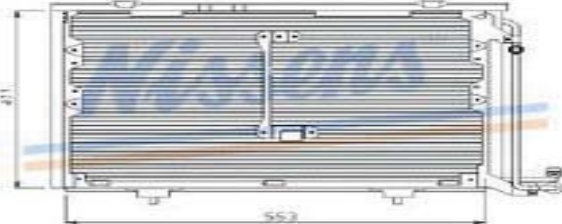

MD20300-930	2035000054/0554/0954/1254	94544	W203 00- {+W209 02-} КОНДЕНСАТОР КОНДИЦ (NISSENS)						640 374 16
			C-CLASS W 203 160 KOMPR.	M271.946	G	M/A	+/-	05/00 -	
			C-CLASS W 203 180	M111.951	G	M/A	+/-	09/00 -	
			C-CLASS W 203 180 KOMPR.	M271.946	G	M/A	+/-	05/00 -	
			C-CLASS W 203 200 CGI	M271.942	G	M/A	+/-	05/00 -	
			C-CLASS W 203 200 CGI KOMPR.	M271.942	G	A	+/-	05/00 -	
			C-CLASS W 203 200 KOMPR.	M111.955	G	M/A	+/-	05/00 -	
			C-CLASS W 203 230	M272.920	G	M/A	+/-	04/00 -	
			C-CLASS W 203 230 KOMPR.	M271.948	G	A	+/-	05/00 -	
			C-CLASS W 203 240	M112.946	G	M/A	+/-	04/00 -	
			C-CLASS W 203 240 4-MATIC	M112.946	G	M/A	+/-	04/00 -	
			C-CLASS W 203 280	M272.940	G	A	+/-	04/00 -	
			C-CLASS W 203 280 4-MATIC	M272.940	G	A	+/-	04/00 -	
			C-CLASS W 203 32 AMG KOMPR.	M112.961	G	A	+/-	04/00 -	
			C-CLASS W 203 320	M112.946	G	A	+/-	04/00 -	
			C-CLASS W 203 320 4-MATIC	M112.946	G	A	+/-	04/00 -	
			C-CLASS W 203 350	M272.960	G	A	+/-	04/00 -	

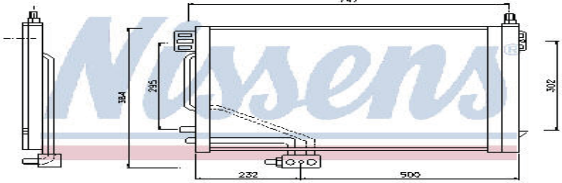

№ФОРВАРДА	№ OEM	№ NISSENS	МОДЕЛЬ	ТИП ДВИГАТЕЛЯ	БЕН/Д ИЗ	ТИП КП	КОНД ИЦИ	ГОД	ПРИМЕЧА НИЕ
			C-CLASS W 203 350 4-MATIC	M272.960	G	A	+/-	04/00 -	
			C-CLASS W 203 36 AMG	M272.940	G	A	+/-	04/00 -	
			C-CLASS W 203 55 AMG	M113.988	G	A	+/-	04/00 -	
			CLK-CLASS W 209 200 CGI	M271.942	G	M/A	+/-	06/02 -	
			CLK-CLASS W 209 200 KOMPR.	M271.940	G	M/A	+/-	06/02 -	
			CLK-CLASS W 209 240	M112.912	G	M/A	+/-	06/02 -	
			CLK-CLASS W 209 280	M272.940	G	M/A	+/-	06/02 -	
			CLK-CLASS W 209 300	M272.940	G	M/A	+/-	06/02 -	
			CLK-CLASS W 209 320	M112.955	G	M/A	+/-	06/02 -	
			CLK-CLASS W 209 350	M272.960	G	M/A	+/-	06/02 -	
			CLK-CLASS W 209 (02-)	M113.968/M203.967	G	M/A	+/-	06/02 -	
			CLK-CLASS W 209 55 AMG	M113.987	G	M/A	+	06/02 -	
			CLK-CLASS W 209 63 AMG	M156.982	G	M/A	+	06/02 -	

MD21095-930 2108300270/0510 94285 W210 '95-03 КОНДЕНСАТОР КОНДИЦ 622 480 16

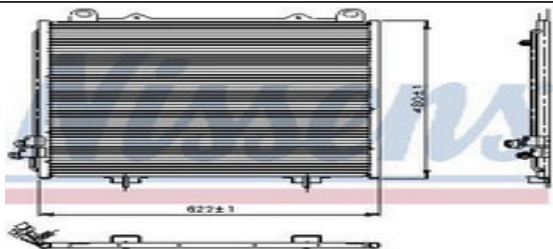

			E-CLASS W 210 E200	M111942	G	M/A	*	95/7-	
			E-CLASS W 210 E200	M111942	G	M/A	*	95/7-	
			E-CLASS W 210 E200	M111970	G	M/A	*	95/7-	
			E-CLASS W 210 E200	M111970	G	M/A	*	95/7-	
			E-CLASS W 210 E240	M112914	G	M/A	*/-	97/6-	
			E-CLASS W 210 E280	M1112921	G	M/A	*/-	97/6	
			E-CLASS W 210 E280	M1112921	G	M/A	*/-	95/7-97/5	
			E-CLASS W 210 E280 4-MATIC	M1112921	G	M/A	*/-	95/7-	
			E-CLASS W 210 E320	M112941	G	M/A	*/-	97/6-	
			E-CLASS W 210 E320	M112941	G	M	*/-	95/7-97/5	
			E-CLASS W 210 E320 4-MATIC	M112941	G	M/A	*/-	97/6-	
			E-CLASS W 210 E320 4-MATIC	M112941	G	M	*/-	95/7-97/5	
			E-CLASS W 210 E420	M119985	G	M/A	*/-	96/1-97/6	
			E-CLASS W 210 E430	M113940	G	M/A	*/-	97/6-	
			E-CLASS W 210 E430	M113940	G	M/A	*/-	98/4-	
			E-CLASS W 210 E430 4-MATIC	M113940	G	M/A	*/-	97/6-	
			E-CLASS W 210 E430 4-MATIC	M113940	G	M/A	*/-	98/4-	

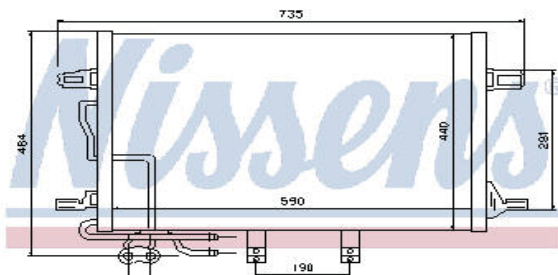

MD21102-930 2115000154/0254/0654/1154/1854 94614 W211 02- {+W219 05-} КОНДЕНСАТОР КОНДИЦ (NISSENS) 630 441 16



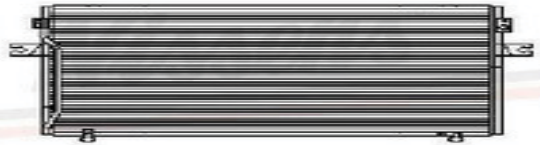
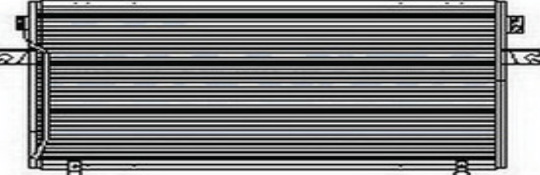

			CLS-CLASS W 219 320 CDI	M 642.920	D	M/A	+	01/05 -	
			CLS-CLASS W 219 350	M 272.964	G	M/A	+	10/04 -	
			CLS-CLASS W 219 350 CGI	722.906	G	M/A	+	01/05 -	
			CLS-CLASS W 219 500	M 113.967/M272.960	G	M/A	+	10/04 -	
			CLS-CLASS W 219 55 AMG	M 113.990	G	M/A	+	01/05 -	
			E-CLASS W 211 200	M271.946	G	M/A	+/-	09/02 -	
			E-CLASS W 211 CDI	M 646.820/M646.951	D	M/A	+/-	09/02 -	
			E-CLASS W 211 200 KOMPR.	M 271.941	G	M/A	+/-	09/02 -	
			E-CLASS W 211 220 CDI	M 646.821/M646.961	D	M/A	+/-	09/02 -	
			E-CLASS W 211 240	M 112.913	G	M/A	+/-	09/02 -	
			E-CLASS W 211 240 4-MATIC	M 112.917	G	A	+/-	09/02 -	
			E-CLASS W 211 270 CDI	M 647.961	D	M/A	+/-	09/02 -	
			E-CLASS W 211 280	M 272.943	G	M/A	+/-	09/02 -	
			E-CLASS W 211 280 4-MATIC	M 272.944	G	M/A	+/-	09/02 -	
			E-CLASS W 211 280 CDI	M 642.920/648.961	D	M/A	+/-	09/02 -	

№ФОРВАРДА	№ OEM	№ NISSENS	МОДЕЛЬ	ТИП ДВИГАТЕЛЯ	БЕН/Д ИЗ	ТИП КП	КОНД ИЦИ	ГОД	ПРИМЕЧА НИЕ
			E-CLASS W 211 280 CDI 4-MATIC	M 642.921	D	M/A	+/-	09/02 -	
			E-CLASS W 211 320	M 112.949	G	M/A	+/-	09/02 -	
			E-CLASS W 211 320 4-MATIC	M 112.954	G	A	+/-	09/02 -	
			E-CLASS W 211 320 CDI	M 642.920-M642.921	D	M/A	+/-	09/02 -	
			E-CLASS W 211 320 CDI 4-MATIC	M 642.921	D	M/A	+/-	09/02 -	
			E-CLASS W 211 350	M 272.964	G	M/A	+/-	09/02 -	
			E-CLASS W 211 350 4-MATIC	M 272.972	G	M/A	+/-	09/02 -	
			E-CLASS W 211 400 CDI	M 628.961	D	M/A	+/-	09/02 -	
			E-CLASS W 211 420 CDI	M 629.910	D	M/A	+/-	09/02 -	
			E-CLASS W 211 500	M 113.967/M273.960	G	M/A	+/-	09/02 -	
			E-CLASS W 211 500 4-MATIC	M 113.969	G	A	+/-	09/02 -	
			E-CLASS W 211 500 4-MATIC	M 273.962	G	M/A	+/-	09/02 -	
			E-CLASS W 211 55 AMG	M 113.990	G	M/A	+/-	09/02 -	
			E-CLASS W 211 63 AMG	M 113.990	G	M/A	+/-	09/02 -	
MD22098-930	2205000054/0154/0854/1054	94380	W220 '98- {+ W215 '99-} КОНДЕНСАТОР КОНДИЦ (NISSENS)						580 478 16
			CL-CLASS W 215 500	M113.960	G	A	+	03/99 -	
			CL-CLASS W 215 55 AMG	M113.960	G	A	+	10/99 -	
			CL-CLASS W 215 600	M113.960	G	A	+	03/99 -	
			CL-CLASS W 215 65 AMG	M275.980	G	A	+	09/03 -	
			S-CLASS W 220 280	M112.922	G	A	+/-	09/97 - 04/99	
			S-CLASS W 220 280	M112.922	G	A	+/-	04/99 -	
			S-CLASS W 220 320	M112.944	G	A	+/-	06/97 - 04/99	
			S-CLASS W 220 320	M112.944	G	A	+/-	04/99 -	
			S-CLASS W 220 320 CDI	OM613.960	D	A	+/-	01/00 -	
			S-CLASS W 220 350	M112.972	G	A	+/-	04/99 -	
			S-CLASS W 220 350 4-MATIC	M112.975	G	A	+/-	04/99 -	
			S-CLASS W 220 400 CDI	OM628.960	D	A	+/-	06/00 -	
			S-CLASS W 220 430	M113.941	G	A	+/-	02/98 - 04/99	
			S-CLASS W 220 430	M113.941	G	A	+/-	04/99 -	
			S-CLASS W 220 430 4-MATIC	M113.948	G	A	+/-	04/99 -	
			S-CLASS W 220 500	M113.960	G	A	+/-	02/98 - 04/99	
			S-CLASS W 220 500	M113.960	G	A	+/-	04/99 -	
			S-CLASS W 220 500 4-MATIC	M113.966	G	A	+/-	04/99 -	
			S-CLASS W 220 55 AMG	M 113.986	G	A	+/-	04/99 -	
			S-CLASS W 220 55 AMG KOMPR.	M 113.991	G	A	+/-	06/02 -	
			S-CLASS W 220 600	M137.970	G	A	+/-	01/00 -	
			S-CLASS W 220 65 AMG	M 275.980	G	A	+/-	03/04 -	
			SL-CLASS W 230 350	M 112.973	G	M/A	+	10/01 -	
			SL-CLASS W 230 500	M 113.963	G	M/A	+	10/01 -	
			SL-CLASS W 230 600	M 275.951	G	M/A	+	10/01 -	
			SL-CLASS W 230 55 AMG	M 113.992	G	M/A	+	10/01 -	
MZ32394-930	B02H61480B/C	94354	323 '94- КОНДЕНСАТОР КОНДИЦ (NISSENS)						647 298 20
			MAZDA 323 1,3i 16V	B3	G	*/-	M	4/94-	
			MAZDA 323 1,5i 16V	Z5	G	*/-	M	10/96-	
			MAZDA 323 1,5i 16V	Z5	G	*/-	A	4/94-	
			MAZDA 323 1,6i 16V	1,6	G	*/-	M	10/96-	
			MAZDA 323 1,6i 16V	1,6	G	*/-	A	10/96-	
			MAZDA 323 1,7 TD	4EET	D	*	M	4/94-	
			MAZDA 323 1,8i 16V	BP	G	*/-	M	4/94-	
			MAZDA 323 1,8i 16V	BP	G	*/-	A	4/94-	
			MAZDA 323 2,0 D	RF	D	*	M	8/95-	

№ФОРВАРДА	№ OEM	№ NISSENS	МОДЕЛЬ	ТИП ДВИГАТЕЛЯ	БЕН/Д ИЗ	ТИП КП	КОНД ИЦИ	ГОД	ПРИМЕЧА НИЕ
NNALM95-930	921102M112/110/111/122	94361	ALMERA '95-96 КОНДЕНСАТОР КОНДИЦ (NISSENS)						690 291 16
NNALM95-932	921102M112/110/111/122	94361	ALMERA '95-96 КОНДЕНСАТОР КОНДИЦ						690 291 16
				ALMERA N15 1,4i16V	GA14DE	G	M	*/-	95/9-99/12
				ALMERA N15 1,6 i 16V	GA16DE	G	M	*/-	95/99/12
				ALMERA N15 2,0D	CD20	D	M	*/-	95/9-99/12
NNMXQ95-930	9211040U20/31U10	94401	MAXIMA QX '95-97 КОНДЕНСАТОР КОНДИЦ (NISSENS)						695 365 25
NNMXQ95-931	9211040U20/31U10	94401	MAXIMA QX '95-97 КОНДЕНСАТОР КОНДИЦ						695 365 25
				MAXIMA QX 2,0 i V6 24V	VQ20DE	G	M/A	*	3/94-96
				MAXIMA QX 3,0 i V6 24V	VQ30DE	G	M/A		
NNMXQ96-930	921100L710	94297	MAXIMA QX '96-98 {7/96-12/97} КОДЕНСАТОР КОНДИЦ						697 388 16
NNMXQ96-931		94297	MAXIMA QX {7/96-12/97} КОНДЕНСАТОР КОНДИЦ						697 388 16
				MAXIMA QX 2,0 i V6 24V	VQ20DE	G	M/A	*	96/1-97/12
				MAXIMA QX 3,0 i V6 24V	VQ30DE	G	M/A	*	96/1-97/12

№ФОРВАРДА	№ OEM	№ NISSENS	МОДЕЛЬ	ТИП ДВИГАТЕЛЯ	БЕН/Д ИЗ	ТИП КП	КОНД ИЦИ	ГОД	ПРИМЕЧА НИЕ
NNP1090-930	9211060J00	94023	P10 '90-92 КОНДЕНСАТОР КОНДИЦ (R12) (NISSENS)						597 305 25
			PRIMERA P10 1,6i 16V	GA16DS	G	M	*/-	90/7-	
			PRIMERA P10 1,6i 16V	GA16DS	G	M	*/-	90/5	
			PRIMERA P10 1,8i 16V	SR18I	G	M	*/-	90/8-	
			PRIMERA P10 1,8i 16V	SR18I	G	A	*/-	90/8-	
			PRIMERA P10 2,0 D	CD20	D	M	*/-	90/12-	
			PRIMERA P10 2,0 GT	SR20DE EGI	G	M	*/-	90/7-	
			PRIMERA P10 2,0 I 16V	2,0	G	A	*/-	90/1-	
			PRIMERA P10 2,0 I 16V	SR20DE	G	M	*/-	90/8-	
			PRIMERA P10 2,0 I 16V	SR20DE	G	A	*/-	90/8-	
			PRIMERA P10 2,0 I 16V	SR20DI SPI	G	M	*/-	90/7-	
			PRIMERA W10 2,0 D	CD20	D	M	*/-	90/6-96/10	
			PRIMERA W10 2,0 D	CD20	D	A	*/-	90/6-96/10	
			PRIMERA W10 1,6 i 16V	CA16DS	G	M	*/-	90/6-96/10	
			NNP1197-930	921102F000/005/515	94299	P11 '97-99 КОНДЕНСАТОР КОНДИЦ (NISSENS)			
NNP1197-931	921102F005	94299	P11 97-99 {735x331mm} КОНДЕНСАТОР КОНДИЦ						735 331 16
			PRIMERA P 11 1,6 I 16V	GA16DE	G	*/-	M	10/96-	
			PRIMERA P 11 1,6 I 16V	GA16DE	G	*/-	A	10/96-	
			PRIMERA P 11 1,6 I 16V	GA16DE	G	*/-	M	10/96-	
			PRIMERA P 11 1,6 I 16V	GA16DE	G	*/-	A	10/96-	
			PRIMERA P 11 1,8 I 16V	GA18DE	G	*/-	M	10/96-	
			PRIMERA P 11 1,8 I 16V	GA18DE	G	*/-	A	10/96-	
			PRIMERA P 11 2,0 D	CD20T	D	*/-	M	10/96-	
			PRIMERA P 11 2,0 D	CD20T	D	*/-	A	10/96-	
			PRIMERA P 11 2,0 i 16V	SP20DE	G	*/-	M	10/96-	
			PRIMERA P 11 2,0 i 16V	SP20DE	G	*/-	A	10/96-	
			OPAST98-930	1850055/057/074/9119176	94384	ASTRA '98- КОНДЕНСАТОР КОНДИЦ (NISSENS)			
			ASTRA 2,2 I 16V	2198Z22SE	G	*	A	12/97-	
			ASTRA G 1,4 I 16V	1389X14XE	G	*	A	12/97-	
			ASTRA G 1,6 i	1598X16SZR	G	*	A	97/12-	
			ASTRA G 1,6 i	1598Z16YNG	G	*	A	97/12	
			ASTRA G 1,6 I 16V	1598X16XEL	G	*	A	12/97-	
			ASTRA G 1,6 I 16V	1598X16XE	G	*	A	12/97-	
			ASTRA G 1,8 I 16V	1796X18XE	G	*	A	12/97-	
			ASTRA G 2,0 I 16V	1998X20XEV	G	*	A	12/97-	
			ZAFIRA 1,6 I 16V	1598X16XEL	G	*	A	12/97-	
			ZAFIRA 1,6 I 16V	1598X16XE	G	*	A	12/97-	
			ZAFIRA 1,6 I 16V	1598Z16XE	G	*	A	12/97-	
			ZAFIRA 1,8 I 16V	1796X18XE	G	*	A	12/97-	
			ZAFIRA 2,0 I 16V	1998X20XEV	G	*	A	12/97-	
			ZAFIRA 2,2 I 16V	2198Z22SE	G	*	A	2/00-	

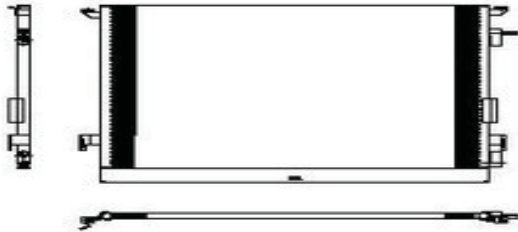
№ ФОРВАРДА	№ OEM	№ NISSENS	МОДЕЛЬ	ТИП ДВИГАТЕЛЯ	БЕН/Д ИЗ	ТИП КП	КОНД ИЦИ	ГОД	ПРИМЕЧА НИЕ
OPAST04-930	1850096/93178958	94767	ASTRA '04- (+ ZAFIRA 05-) КОНДЕНСАТОР КОНДИЦ (NISSENS)						555 382 12
			ASTRA H (04-) 1.2 i 16V	Z12XEP	G	M/A	+/-	03/04 -	
			ASTRA H (04-) 1.4 i 16V	Z14XEL	G	M/A	+/-	03/04 -	
			ASTRA H (04-) 1.4 i 16V	Z14XEP	G	M/A	+/-	03/04 -	
			ASTRA H (04-) 1.6 i	Z16SE	G	M	+/-	03/04 -	
			ASTRA H (04-) 1.6 i 16V	Z16XEP	G	M	+/-	03/04 -	
			ASTRA H (04-) 1.8 i 16V	Z18XE	G	M/A	+/-	03/04 -	
			ASTRA H (04-) 1.8 i 16V	Z18XER	G	M	+/-	03/04 -	
			ZAFIRA B (05-) 1.6 GAS	Z16YNG	G	M	+/-	09/05 -	
			ZAFIRA B (05-) 1.6 i 16V	Z16XEP	G	M	+/-	09/05 -	
			ZAFIRA B (05-) 1.8 i 16V	Z18XER	G	M	+/-	09/05 -	
			ASTRA H (04-) 1.2 i 16V	Z12XEP	G	M/A	+/-	03/04 -	
			ASTRA H (04-) 1.4 i 16V	Z14XEL	G	M/A	+/-	03/04 -	
			ASTRA H (04-) 1.4 i 16V	Z14XEP	G	M/A	+/-	03/04 -	
			ASTRA H (04-) 1.6 i	Z16SE	G	M	+/-	03/04 -	
			ASTRA H (04-) 1.6 i 16V	Z16XEP	G	M	+/-	03/04 -	
			ASTRA H (04-) 1.8 i 16V	Z18XE	G	M/A	+/-	03/04 -	
			ASTRA H (04-) 1.8 i 16V	Z18XER	G	M	+/-	03/04 -	
			ZAFIRA B (05-) 1.6 GAS	Z16YNG	G	M	+/-	09/05 -	
ZAFIRA B (05-) 1.6 i 16V	Z16XEP	G	M	+/-	09/05 -				
ZAFIRA B (05-) 1.8 i 16V	Z18XER	G	M	+/-	09/05 -				
OPOMB86-930	1850018	94231	OMEGA '86-93 {SENATOR} КОНДЕНСАТОР КОНДИЦ (NISSENS)						640 396 24
			CARLTON B 2,6I		G	M	*	10/86-	
			CARLTON B 3,0I/24V	2969 30NE/C30	G	M	*	10/86-	
			OMEGA A 2,6I	C26NE	G	M	*	10/86-2/94	
			OMEGA A 2,6I	C26NE	G	A	*	10/86-2/94	
			OMEGA A 3,0 i	30NE/LE/SE	G	M	*	10/86-2/94	
			OMEGA A 3,0 i	30NE/LE/SE	G	A	*	10/86-2/94	
			SENATOR 2,6I	C26NE	G	M	*	9/87-	
			SENATOR 2,6I	C26NE	G	A	*	9/87-	
			SENATOR 2,6I				*	9/87-	
			SENATOR 3,0I/24V				*	9/87-	
OPOMB86-931	185016/016	94229	OMEGA '86-94 КОНДЕНСАТОР КОНДИЦ (NISSENS)						640 396 24
			CARLTON B 1,8 N/S/I	1796 18NV/SV/E18	G	M	*/-	10/86-2/94	
			CARLTON B 2,6I		G	M	*	86/10-2/94	
			OMEGA A 2,0	20SE	G	M/A	*	10/86-2/94	R12
			OMEGA A 2,0i	C20NE	G	M/A	*	10/86-2/94	R12
			OMEGA A 2,4i	C24NE	G	M	*	10/86-94/5	

№ФОРВАРДА	№ OEM	№ NISSENS	МОДЕЛЬ	ТИП ДВИГАТЕЛЯ	БЕН/Д ИЗ	ТИП КП	КОНД ИЦИ	ГОД	ПРИМЕЧА НИЕ
ОРОМВ94-930	1850028	94232	OMEGA '94-99 КОНДЕНСАТОР КОНДИЦ (NISSENS)						665 425 25
ОРОМВ94-931	1850028	94232	OMEGA '94-99 КОНДЕНСАТОР КОНДИЦ						665 425 25
			OMEGA 2,0i	20SE/X20SE	G	M/A	*	94/4-	
			OMEGA 2,0i 16V	X20XEV	G	M/A	*/-	94/4-	
			OMEGA 2,5 i V6		G	M/A	*	94/4-	
			OMEGA 3,0 i V6		G	M/A	*	94/4-	
			OMEGA B 2,0 i	20SE/X20SE	G	M/A	*	3/94-	
			OMEGA B 2,0 i 16V	1998X20XEV	G	M/A	*	3/94-	
			OMEGA B 2,2 i 16V	2198Y22XE	G	M/A	*	99/8-	
			OMEGA B 2,2 i 16V	2198Z22XE	G	M/A	*	99/8-	
			OMEGA B 2,5 i V6 24V	2490X25XE	G	M/A	*	94/3-	
			OMEGA B 2,6 i V6 24V	2597Y26SE	G	M/A	*	00/9-	
		OMEGA B 3,0 i V6 24V	2698X30XE	G	M/A	*	94/3-		
		OMEGA B 3,2 i V6 24V	3175Y32SE	G	M/A	*	00/9-		
ОРVCA02-930	1850076	94597	VECTRA '02- {+SIGNUM} КОНДЕНСАТОР КОНДИЦ. (NISSENS)						660 411 16
			CROMA 2,2i 16V	194 A1 000	G	*/-	M	05/01-	
			CROMA 2,2i 16V	194 A1 000	G	*/-	A	05/01-	
			SIGNUM 1,8i 16V	1796 Z18XE	G	*	M	02/04-	
			SIGNUM 1,8i 16V	1796 Z18XEL	G	*	M	02/04-	
			SIGNUM 2,2i 16V	2198 Z22SE	G	*	M	02/04-	
			SIGNUM 2,2i 16V	2198 Z22SE	G	*	A	02/04-	
			SIGNUM 2,2i 16V	2198 Z22SE	G	*	A	02/04-	
			SIGNUM 2,2i 16V	2198 Z22YH	G	*	M	02/04-	
			SIGNUM 2,2i 16V	2198 Z22YH	G	*	A	02/04-	
			SIGNUM 3,2i V6 24V	3175 Z32SE	G	*	M	02/04-	
			SIGNUM 3,2i V6 24V	3175 Z32SE	G	*	A	02/04-	
			VECTRA C 1,6i 16V	1598 Z16XE	G	*	M	02/04-	
			VECTRA C 1,8i 16V	1796Z18XE	G	*	M	02/04-	
			VECTRA C 1,8i 16V	1796Z18XEL	G	*	M	02/04-	
			VECTRA C 2,2i 16V	2198 Z22SE	G	*	M	02/04-	
		VECTRA C 2,2i 16V	2198 Z22SE	G	*	A	02/04-		
		VECTRA C 2,2i 16V	2198 Z22SE	G	*	A	02/04-		
		VECTRA C 2,2i 16V	2198 Z22YH	G	*	M	02/04-		
		VECTRA C 2,2i 16V	2198 Z22YH	G	*	A	02/04-		
		VECTRA C 3,2i V6 24V	3175 Z32SE	G	*	M	02/04-		
		VECTRA C 3,2i V6 24V	3175 Z32SE	G	*	A	02/04-		
ОРVCA88-930	1850015	94227	VECTRA '88-95 {+CALIBRA 92-93} КОНДЕНСАТОР КОНДИЦ						622 358 16
			CALIBRA 2,0 TURBO	1998 C20LET	G	M	*	92/3-97/6	
			CALIBRA 2,0	1998 C20NE	G	M	*	90/3-	
			CALIBRA 2,0 i 16V	1998 C20XE	G	M	*	90/3-	
			CALIBRA 2,0 i 16V	1998 X20XEV	G	M	*	90/3-	
			VECTRA A 1,4	14NV	G	M	*	88/9-90/10	
			VECTRA A 1,4	14NV	G	M	*	88/9-90/10	
			VECTRA A 1,6i	C16NZ	G	M	*	88/9-95/9	
			VECTRA A 1,6i	C16NZ	G	M	*	88/9-95/9	
			VECTRA A 1,6i	X16SZ	G	M	*	88/9-95/9	
			VECTRA A 1,6i	X16SZ	G	M	*	88/9-95/9	
			VECTRA A 1,8i	C18NZ	G	M	*	88/9-95/9	
			VECTRA A 1,8i	C18NZ	G	M	*	88/9-95/9	
		VECTRA A 2,0 TURBO	C20LET	G	M	*/-	90/9-95/9		

№ФОРВАРДА	№ OEM	№ NISSENS	МОДЕЛЬ	ТИП ДВИГАТЕЛЯ	БЕН/Д ИЗ	ТИП КП	КОНД ИЦИ	ГОД	ПРИМЕЧА НИЕ
			VECTRA A 2,0 TURBO	C20LET	G	M	*/-	90/9-95/9	
			VECTRA A 2,0 i	20SEH	G	M	*	88/9-95/9	
			VECTRA A 2,0 i	20SEH	G	M	*	88/9-95/9	
			VECTRA A 2,0 i	C20NE	G	M	*	88/9-95/9	
			VECTRA A 2,0 i 16V	C20XE	G	M	*	88/9-95/9	
			VECTRA A 2,0 i 16V	C20XE	G	M	*	88/9-95/9	
			VECTRA A 2,0 i 16V	X20XEV	G	M	*	88/9-95/9	
			VECTRA A 2,0 i 16V	X20XEV	G	M	*	88/9-95/9	
			VECTRA A 2,5 i V6 24V	C25XE	G	M/A	*/-	92/9-95/9	
			VECTRA A 2,5 i V6 24V	C25XE	G	M/A	*/-	92/9-95/9	
OPVCA96-930	1850041	94234	VECTRA '96-99 КОНДЕНСАТОР КОНДИЦ (NISSENS)						605 360 25
OPVCA96-931	1850041	94234	VECTRA '96-99 КОНДЕНСАТОР КОНДИЦ						605 360 25
			VECTRA 1,6	1598X16SZR	G	M	*	95/10-02/3	
			VECTRA 1,6 i	1598X16XEL	G	M	*	95/10-99/1	
			VECTRA 1,6 i 16V	1598X16XEL	G	M	*	95/10-02/3	
			VECTRA 1,8 i 16V	1598X16XEL	G	M	*	95/10-02/3	
			VECTRA 2,0i	1998 20NEJ	G	M	*	95/10-00/6	
			VECTRA 2,0i 16V	1998 20NEJ	G	M	*	95/10-00/6	
			VECTRA B 1,6	1598 16LZ2	G	M	*	95/10-02/3	
			VECTRA B 1,6 i	1598X16SZR	G	M	*	95/10-99/1	
			VECTRA B 1,6 i 16V	1598Z16XE	G	M	*	95/10-02/3	
			VECTRA B 1,8 i 16 V	1796X18XE	G	M	*	95/10-02/3	
			VECTRA B 1,8 i 16 V	1796X18XE1	G	M	*	95/10-02/3	
			VECTRA B 1,8 i 16 V	1796Z18XE	G	M	*	95/10-02/3	
			VECTRA B 1,8 i 16 V	1796Z18XEL	G	M	*	95/10-02/3	
			VECTRA B 2,0i	1998 20NEJ	G	M	*	95/10-00/6	
			VECTRA B 2,0i 16V	1998 C20SEL	G	M	*	95/10-00/6	
			VECTRA B 2,0i 16V	1998X20XEV	G	M	*	95/10-00/6	
			VECTRA B 2,5 i V6 24V	2490X25XE	G	M	*	95/10-	
			VECTRA B 2,6 i V6 24V	2588Y26SE	G	M	*	95/10-	
			VECTRA B 1,6 i 16V	1598X16XEL	G	M	*	95/10-02/3	
			VECTRA B 1,6 i 16V	1598Y16XE	G	M	*	95/10-02/3	
PG40695-930	6455Y1/53V0	94224	406 '95-98 КОНДЕНСАТОР КОНДИЦ (NISSENS)						690 381 16
PG40695-931	6455Y1/53V0	94224	406 '95-98 КОНДЕНСАТОР КОНДИЦ						690 381 16
			406 1,8 i	1761 XU7JP	G	A	*	95/9-99/4	
			406 1,8 i 16V	1761 XU7JP4	G	A	*	96/7-99/3	
			406 2,0 i 16V	1998 XU10J4R	G	A	*	95/10-99/4	
			406 3,0 i V6 24V	2946 ES9J4	G	A	*/-	96/10-	
			406 COUPE 3,0 i V6 24V	ES9J4	G	A	*/-	99/4-	



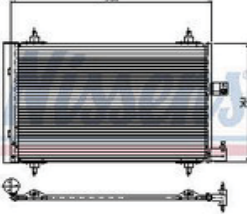
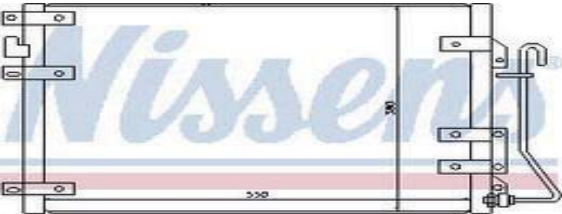



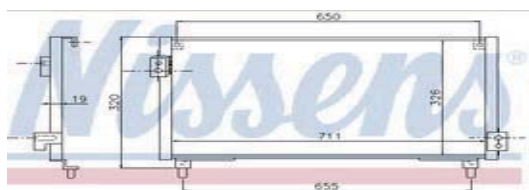
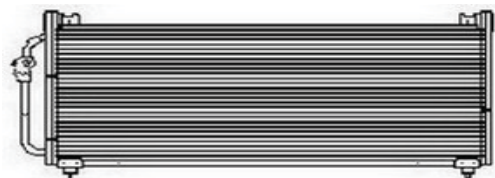
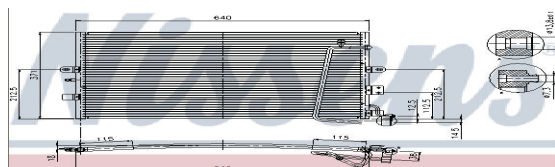

№ ФОРВАРДА	№ OEM	№ NISSENS	МОДЕЛЬ	ТИП ДВИГАТЕЛЯ	БЕН/Д ИЗ	ТИП КП	КОНД ИЦИ	ГОД	ПРИМЕЧА НИЕ
PG40699-930	6453EC/6455AS/6455/AQ	94534	406 '99- {+ 607 00-/CT XSARA 00-} КОНДЕНСАТОР КОНДИЦ. (NISSENS)						560 361 16
			PEUGEOT 406 1,6i	1580XU5JP	G	*	M	99/4-	TROPIC
			PEUGEOT 406 1,8i	1761XU7JB	G	*	M	99/4-	
			PEUGEOT 406 1,8i	1761XU7JP	G	*	M	99/4-	
			PEUGEOT 406 1,8i 16V	1749EW7J4	G	*	M	99/4-	
			PEUGEOT 406 1,8i 16V	1761XU7JP4	G	*	M	99/4-	
			PEUGEOT 406 2,0Hdi	1997DW10ATED/TD	D	*	M	99/4-	
			PEUGEOT 406 2,0Hdi	1997DW10ATED/TD	D	*/-	M	99/4-	
			PEUGEOT 406 2,0i 16V	1997EW10J4	G	*	M	99/4-	
			PEUGEOT 406 2,0i 16V	1997EW10J4	G	*	A	99/4-	
			PEUGEOT 406 2,0i 16V	1997XU10J4R	G	*	M	99/4-	
			PEUGEOT 406 2,0i 16V	1997XU10J4R	G	*	A	99/4-	
			PEUGEOT 406 2,2Hdi	2179DW12TED4	D	*	M	01/5-	
			PEUGEOT 406 2,2Hdi	2179DW12TED4	D	*/-	M	00/10-	
			PEUGEOT 406 2,2i 16V	2230EW12J4	G	*/-	M	00/5-	
			PEUGEOT 406 COUPE 2,0i 16V	EW10J4	G	*/-	M	99/4-	
			PEUGEOT 406 COUPE 2,0i 16V	EW10J4	G	*/-	A	99/4-	
			PEUGEOT 406 COUPE 2,2 Hdi	DW12TED4	D	*/-	M	99/4-	
			PEUGEOT 406 COUPE 2,2i 16V	EW10J4	G	*/-	M	99/4-	
			PEUGEOT 607 2,0 HDI	1997DW10ATED	D	*	M	00/5	
			PEUGEOT 607 2,0 HDI	1997DW10BTED4	D	*	M	00/5	
			PEUGEOT 607 2,0i 16V	1997EW10J4	G	*/-	M	00/5-	
			PEUGEOT 607 2,2 HDI	2179DW12TED4	D	*/-	M	00/5	
			PEUGEOT 607 2,2 HDI	2179DW12TED4	D	*/-	A	00/5	
			PEUGEOT 607 2,2i 16V	2230EW12J4	G	*/-	M	00/5-	
			PEUGEOT 607 2,2i 16V	2230EW12J4	G	*/-	A	00/5-	
			PEUGEOT 607 3,0i V6 24V	2946ES9J4S	G	*/-	M	00/5	
			PEUGEOT 607 3,0i V6 24V	2946ES9J4S	G	*/-	A	00/5	
			XSARA 2,0 HDi	1997DW10ATED	D	*/-	M	00/9-	
		XSARA 2,0 HDi	1997DW10TD	D	*/-	M	00/9-		
RNCLI01-930	7700428083	94439	CLIO '01- {+ SIMBOL 01-/KANGO 98-03} КОНДЕНСАТОР КОНДИЦ						550 380 19
			KUBISTAR 1,2 i	1149 D7F	G	M	*	03/8-	
			CLIO 1,0 i	999 D7D	G	A	*	00/5-	
			CLIO 1,2 i	1149 D7F	G	M/A	*	99/10-	
			CLIO 1,4 i 16V	1390 K4J	G	M/A	*	99/10-	
			CLIO 2,0 i 16V	1998 F4R	G	M	*	00/1-01/3	
			CLIO 1,2 i	1149 D7F	G	M/A	*	01/4-03/3	
			CLIO 1,2 i 16V	1149 D4D	G	M	*	01/4-	
			CLIO 1,2 i 16V	1149 D4F	G	M/A	*	01/4-03/3	
			CLIO 1,4 i	1390 K7J	G	A	*	01/4-	
			CLIO 1,4 i 16V	1390 K4J	G	M/A	*	01/4-03/3	
			CLIO 1,6 i 16V	1598 K4M	G	M/A	*	01/4-03/3	
			CLIO SYMBOL 1,4 i	1390 K7J	G	A	*	01/4-	
			CLIO SYMBOL 1,4 i 16 V	1390 K4J	G	M/A	*	01/4-03/3	
			THALIA 1,4 i	1390 K7J	G	A	*	01/4-	
			THALIA 1,4 i 16V	1390 K4J	G	M/A	*	01/4-03/3	
			CLIO 1,9 dTi	1870 F9Q	G	A	*	01/4-	
			KANGOO 1,2 i	1149 D7F	D	M	*	98/1-	
			KANGOO 1,2 i 16V	1149 D4D	G	M	*	98/1-	
			KANGOO 1,2 i 16V	1149 D4F	G	M	*	98/1-	
			KANGOO 1,5 Dci	1461 K9K	G	M	*	01/10-02/9	
		KANGOO 1,5 Dci	1461 K9K	G	M	*	02/9-03/3		
		KANGOO 1,6 i 16V	1598 K4M	G	M/A	*	02/1-		

№ФОРВАРДА	№ OEM	№ NISSENS	МОДЕЛЬ	ТИП ДВИГАТЕЛЯ	БЕН/Д ИЗ	ТИП КП	КОНД ИЦИ	ГОД	ПРИМЕЧА НИЕ
RNMEG03-930	8200115543	94626	MEGANE 03- {+ SCENIC 03-} КОНДЕНСАТОР КОНДИЦ (NISSENS)						598 401 16
RNMEG03-931	8200115543	94626	MEGANE '03- {+ SCENIC 03-} КОНДЕНСАТОР КОНДИЦ						598 401 16
			MEGANE 1.4 i 16V	K4J	G	M	+/-	09/02 -	
			MEGANE 1.5 dCi	K9K	D	M	+/-	09/02 -	
			MEGANE 1.6 i 16V	K4M	G	M	+/-	09/02 -	
			MEGANE 1.6 i 16V	K4M	G	A	+/-	09/02 -	
			MEGANE 1.9 dCi	F9Q	D	M	+/-	09/02 -	
			MEGANE 2.0 i 16V	F4R	G	M	+/-	09/02 -	
			MEGANE 2.0 i 16V	F4R	G	A	+/-	09/02 -	
			MEGANE 2.0 i 16V	F4R	G	M	+/-	06/02 - 08/02	
			SCENIC 1.4 i 16V	K4J	G	M	+/-	06/03 -	
			SCENIC 1.5 dCi	K9K	D	M	+/-	06/03 -	
			SCENIC 1.6 i 16V	K4M	G	A	+/-	06/03 -	
			SCENIC 1.6 i 16V	K4M	G	M	+/-	06/03 -	
			SCENIC 1.9 dCi	F9Q	D	M	+/-	06/03 -	
			SCENIC 2.0 i 16V	F4R	G	A	+/-	06/03 -	
		SCENIC 2.0 i 16V	F4R	G	M	+/-	06/03 -		
RV20095-930	JRB100310	94255	ROVER 200 '01- {+ 400 95-/25 99-/45 99-} КОНДЕНСАТОР КОНДИЦ (NISSENS)						600 291 16
			CIVIC (95-) 2.0 TD	20T2	D	M	+/-	01/96 - 09/98	
			ZR (01-) 1.4 i	14K4F	G	M	+	11/04 -	
			ZR (01-) 1.4 i	14K4F	G	M	+	09/01 - 11/04	
			ZR (01-) 1.6 i	16K4F	G	M	+	11/04 -	
			ZR (01-) 1.6 i	16K4F	G	M	+	09/01 - 11/04	
			ZR (01-) 1.8 i	18K4FL32	G	M/A	+/-	11/04 -	
			ZR (01-) 1.8 i	18K4FL32	G	M/A	+	09/01 - 11/04	
			ZR (01-) 2.0 D	20T2N10N	G	M	+/-	09/01 -	
			ZR (01-) 2.0 TD	20T2N10N	G	M	+/-	09/01 -	
			ZS (01-) 1.4 i	14K4F	G	M	+	09/01 -	
			ZS (01-) 1.4 i 16V	14K4F	G	M	+/-	09/01 -	
			ZS (01-) 1.6 i	16K4F	G	M	+	09/01 -	
			ZS (01-) 1.6 i 16V	16K4F	G	M	+/-	09/01 -	
			ZS (01-) 1.8 i	18K4F	G	M	+	09/01 -	
			ZS (01-) 1.8 i 16V	18K4F	G	M	+/-	09/01 -	
			ZS (01-) 2.0 i	20K4F	G	M	+/-	09/01 -	
			ZS (01-) 2.0 TD	20T2N10N	G	M	+/-	09/01 -	
			ZS (01-) 2.0 Tdi	20T2N10N	G	M	+/-	09/01 -	
			200 (95-) 1.4 i	14K14	G	M	+	09/95 - 11/99	
			200 (95-) 1.6 i	16K16	G	M	+	09/95 - 11/99	
			200 (95-) 1.6 i	16K16	G	A	+/-	09/95 - 11/99	
			200 (95-) 1.8 i	18K16	G	M/A	+	09/95 - 11/99	
			200 (95-) 2.0 D	20T2R	D	M	+/-	09/95 - 11/99	
			200 (95-) 2.0 TD	20T2N	D	M	+/-	09/95 - 11/99	
			25 (99-) 1.4 i	14K4F	G	M	+/-	11/04 -	
			25 (99-) 1.4 i	14K4F	G	M	+	07/99 - 11/04	
			25 (99-) 1.6 i	16K4F	G	M	+/-	11/04 -	
			25 (99-) 1.6 i	16K4F	G	M	+	07/99 - 11/04	
			25 (99-) 1.8 i	18K4F	G	M/A	+/-	11/04 -	
			25 (99-) 1.8 i	18K4F	G	M/A	+	07/99 - 11/04	
			25 (99-) 2.0 D	20T2N10N/20T2N10N/11N	D	M	+/-	07/99 -	
			25 (99-) 2.0 TD	20T2N10N	D	M	+/-	07/99 -	
			400 (95-) 1.4 i	14K14	G	M	+	09/95 - 11/99	
			400 (95-) 1.4 i 16V	14K14	G	M	+/-	09/95 - 11/99	
		400 (95-) 1.6 i	16K16	G	M	+	09/95 - 11/99		
		400 (95-) 1.6 i 16V	16K16	G	M	+/-	09/95 - 11/99		

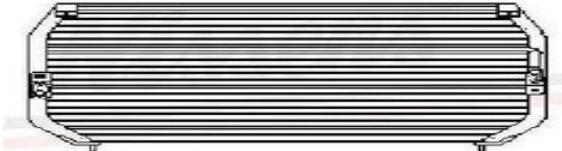
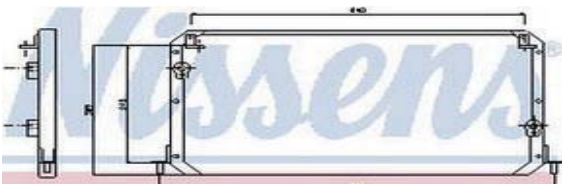
№ФОРВАРДА	№ OEM	№ NISSENS	МОДЕЛЬ	ТИП ДВИГАТЕЛЯ	БЕН/Д ИЗ	ТИП КП	КОНД ИЦИ	ГОД	ПРИМЕЧА НИЕ
		400 (95-) 1.8 i		18K4FL32	G	M	+	09/95 - 11/99	
		400 (95-) 1.8 i 16V		18K4FL32	G	M	+/-	09/95 - 11/99	
		400 (95-) 2.0 i		T16	G	M	+/-	09/95 - 11/99	
		400 (95-) 2.0 D		20T2R	D	M	+/-	09/95 - 11/99	
		400 (95-) 2.0 TD		20T2N	D	M	+/-	09/95 - 11/99	
		400 (95-) 2.0 Tdi		20T2N	D	M	+/-	09/95 - 11/99	
		45 (99-) 1.4 i		14K4F	G	M	+	09/99 -	
		45 (99-) 1.4 i 16V		14K4F	G	M	+/-	09/99 -	
		45 (99-) 1.6 i		16K4F	G	M	+	09/99 -	
		45 (99-) 1.6 i 16V		16K4F	G	M	+/-	09/99 -	
		45 (99-) 1.8 i		18K4F	G	M	+	09/99 -	
		45 (99-) 1.8 i 16V		18K4F	G	M	+/-	09/99 -	
		45 (99-) 2.0 i		20K4F	G	M	+/-	09/99 -	
		45 (99-) 2.0 TD		20T2N	D	M	+/-	09/99 -	
		45 (99-) 2.0 Tdi		20T2N	D	M	+/-	09/99 -	
SA09597-930	4541215	94301	SAAB 9-5 '97- КОНДЕНСАТОР КОНДИЦ (NISSENS)						640 371 16
SA09597-931		94301	SAAB 9-5 '97- КОНДЕНСАТОР КОНДИЦ (NISSENS)						640 371 16
			9-5 (97-) 2.0 i 16V TURBO	B205L	G	M	+/-	06/97 -	
			9-5 (97-) 2.0 i 16V TURBO	B205L	G	A	+/-	06/97 -	
			9-5 (97-) 2.0 i 16V TURBO	B205R	G	M	+/-	06/98 -	
			9-5 (97-) 2.0 i 16V TURBO	B205R	G	A	+/-	06/98 -	
			9-5 (97-) 2.2 TiD	D223L	D	M	+/-	06/97 -	
			9-5 (97-) 2.2 TiD	D223L	D	A	+/-	06/98 -	
			9-5 (97-) 2.3 i 16V TURBO	B235L	G	M	+/-	06/97 -	
			9-5 (97-) 2.3 i 16V TURBO	B235L	G	A	+/-	06/97 -	
			9-5 (97-) 3.0 i V6 24V TURBO	B308L	G	M	+	06/97 -	
			9-5 (97-) 3.0 i V6 24V TURBO	B308L	G	A	+	06/97 -	
			9-5 (97-) 3.0-TiD-V6	D308L	D	M	+/-	06/97 -	
			9-5 (97-) 3.0-TiD-V6	D308L	D	A	+/-	06/98 -	
SBIMP93-930	73210FA000	94364	IMPREZA '93-01 КОНДЕНСАТОР КОНДИЦ (NISSENS)						735 291 25
			IMPREZA 1,5 I 16V	EJ15	G	*/-	M	8/92-	
			IMPREZA 1,6 I 16V	EJ16	G	*/-	M	8/92-	
			IMPREZA 1,6 I 16V	EJ16	G	*/-	A	8/92-	
			IMPREZA 1,8 I 16V	EJ16	G	*/-	A	8/92-	
			IMPREZA 1,8 I 16V	EJ18	G	*/-	M	8/92-	
SBIMP93-931	73020G151	94365	IMPREZA '93-01 КОНДЕНСАТОР КОНДИЦ (NISSENS)						711 326 19
			IMPREZA 1,6 I 16V	EJ16	G	*/-	M	8/92-	
			IMPREZA 1,6 I 16V	EJ16	G	*/-	A	8/92-	
			IMPREZA 1,8 I 16V	EJ16	G	*/-	A	8/92-	
			IMPREZA 1,8 I 16V	EJ18	G	*/-	M	8/92-	
			IMPREZA 2,0 i	EJ20	G	*/-	M	8/95-7/98	
			IMPREZA 2,0 i	EJ21	G	*/-	A	8/95-7/98	

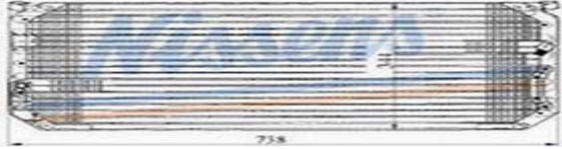

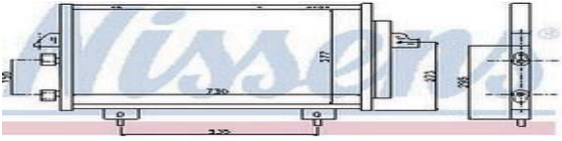
№ФОРВАРДА	№ OEM	№ NISSENS	МОДЕЛЬ	ТИП ДВИГАТЕЛЯ	БЕН/Д ИЗ	ТИП КП	КОНД ИЦИ	ГОД	ПРИМЕЧА НИЕ
SEIBZ93-930	6K0820413A/C	94204	IBIZA '93- {CORDOVA/POLO CLASSIC 96-/INCA} КОНДЕНСАТОР КОНДИЦ (NISSENS)						605 371 16
SEIBZ93-931	6K0820413A/C	94204	IBIZA '93- {CORDOVA/POLO CLASSIC 96-/INCA} КОНДЕНСАТОР КОНДИЦ						605 371 16
			CORDOVA 1,6 i	1595 1F	G	M/A	*	95/9-96/6	
			CORDOVA 1,6 i	1595 1F	G	M/A	*	94/5-96/6	
			CORDOVA 1,8 i	1781 ADZ	G	M/A	*/-	96/7-99/6	
			CORDOVA 1,8 i	1782 ADZ	G	M/A	*/-	96/7-99/6	
			CORDOVA 1,8 i	1781 ABS	G	M/A	*	93/2-94/8	
			CORDOVA 1,8 i	1781 ADZ	G	A	*	94/9-96/6	
			IBIZA 1,6i	1595 1F	G	M/A	*	94/5-99/6	
			IBIZA 1,8i	1781 ABS	G	M/A	*	93/2-94/8	
			IBIZA 1,8i	1781 ADZ	G	M/A	*	94/9-99/6	
			POLO CLASSIC 2,0 i	1984 ADS	G	M/A	*	99/8-99/8	
									
SETOL93-930	1L0820413B	94252	TOLEDO '93-98 КОНДЕНСАТОР КОНДИЦ (NISSENS)						580 281 21
			TOLEDO 1,6 i	1595 1F	G	M	*	91/5-93/9	
			TOLEDO 1,6 i	1595 1F	G	M	*	93/10-99/3	
			TOLEDO 1,6 i	1595 1F	G	M	*	95/9-99/3	
			TOLEDO 1,8i	1781 KR	G	M	*	91/5-92/11	
			TOLEDO 1,8i	1781 PL	G	M	*	91/5-94/3	
			TOLEDO 1,8i	1781 RP	G	M	*	91/5-93/11	
			TOLEDO 1,8i	1781 RP	G	M	*/-	91/5-93/11	
			TOLEDO 2,0	1984 2E	G	M/A	*	91/5-96/7	
			TOLEDO 2,1	1984 2E	G	M	*	91/5-96/7	
									
TYCAE93-930	8846020370/380	94331	CARINA E '93-97 КОНДЕНСАТОР КОНДИЦ (NISSENS)						705 344 25
TYCAE93-931	8846020370/380	94331	CARINA E '93-97 КОНДЕНСАТОР КОНДИЦ						705 344 25
			CARINA E 1,6 i 16V	4A-FE	G	M	*/-	92/2-97/9	
			CARINA E 1,6 i 16V	4A-FE	G	A	*/-	95/2-97/9	
			CARINA E 1,8 i 16V	7A-FE	G	M	*/-	95/2-97/9	
			CARINA E 1,8 i 16V	7A-FE	G	A	*/-	94/8-97/9	
			CARINA E 2,0 D	2,0 2C	D	M	*/-	92/4-97/9	
			CARINA E 2,0 D	2,0 2C	D	A	*/-	92/4-97/9	
			CARINA E 2,0 i 16V	3S-FE	G	M	*/-	92/2-97/9	
			CARINA E 2,0 i 16V	3S-FE	G	A	*/-	92/2-97/9	
			CARINA E 2,0 TD	2,0 C-T	D	M	*/-	92/4-97/9	
			CARINA E 2,0 TD	2,0 C-T	D	A	*/-	92/4-97/9	
									
TYCAM98-930	8846006050/06061	94514	CAMRY '98-01 КОНДЕНСАТОР КОНДИЦ						773 413 22
			LEXUS ES 300 3,0 i V6 24V	1MZFE	G	M/A	*/-	96/8-01/9	
			CAMRY 2,2 i 16V	5SFE	G	A	*/-	96/10-	
			CAMRY 3,0 i V6 24V	1MZFE	G	M/A	*/-	96/8-01/9	
			LEXUS ES 300	3,0 i V6 24V	G	M/A	*/-	96/8-01/9	
									

№ФОРВАРДА	№ OEM	№ NISSENS	МОДЕЛЬ	ТИП ДВИГАТЕЛЯ	БЕН/Д ИЗ	ТИП КП	КОНД ИЦИ	ГОД	ПРИМЕЧА НИЕ
TYCRL94-931	8846012460	94304	COROLLA '94-97 КОНДЕНСАТОР КОНДИЦ (R134A) (NISSENS)						738 344 22
			COROLLA 1,6 i 16V	4AFE	G	M	*/-	92/6-97/10	AE 10#
			COROLLA 1,6 i 16V	4AFE	G	M		92/6-97/4	AE 10#
			COROLLA 1,6 i 16V	4AFE	G	A	*/-	92/6-97/4	AE 10#
			COROLLA 1,8 i 16V	7AFE	G	M	*/-	92/6-97/10	AE 10#
			COROLLA 1,8 i 16V	7AFE	G	M	*/-	92/6-97/4	AE 10#
			COROLLA 1,8 i 16V	7AFE	G	A			AE 10#
TYLAN90-930	8846060060	94187	LANDCRUISER '90-93 КОНДЕНСАТОР КОНДИЦ (NISSENS)						721 330 26
			LANDCRUISER 80/90				*	1/90-5/93	FJ80
			LANDCRUISER 80/90				*	1/90-5/93	FZJ80
			LANDCRUISER 80/90				*	1/90-5/93	HDJ80
			LANDCRUISER 80/90				*	1/90-5/93	HZJ80
TYRV400-930	8846042070/42090	94741	RAV4 '00-05 КОНДЕНСАТОР КОНДИЦ						730 377 16
			RAV4 2,0 i 16V	1998 1AZFE	G	A	*/-	03/7-	
			RAV4 2,0 i 16V	1998 1AZFE	G	A	*/-	00/5-03/7	
			RAV4 2,4 i 16V	2388 2AZFE	G	A	*/-	03/7-	
TYRV494-930	8846042020	94370	RAV4 '94-97 КОНДЕНСАТОР КОНДИЦ (NISSENS)						801 310 22
TYRV494-931	8846042020	94370	RAV4 '94-97 КОНДЕНСАТОР КОНДИЦ						801 310 22
			RAV4 2,0 i 16V	1998 3SFE	G	M	*/-	5/94-8/97	
			RAV4 2,0 i 16V	1998 3SFE	G	M	*/-	9/97-8/00	

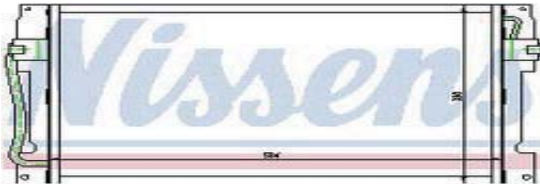
№ФОРВАРДА	№ OEM	№ NISSENS	МОДЕЛЬ	ТИП ДВИГАТЕЛЯ	БЕН/Д ИЗ	ТИП КП	КОНД ИЦИ	ГОД	ПРИМЕЧА НИЕ
VV85091-930	6849575/9171271	94182	850 '91-00 {+S70/V70/C70/XC70} КОНДЕНСАТОР КОНДИЦ. (NISSENS)						584 380 26
VV85091-931	6849575/9171271	94182	850 '91-00 {+S70/V70/C70/XC70} КОНДЕНСАТОР КОНДИЦ.						584 380 26
									
			VOLVO 850 2,0 10V	1984 B5202S	G	*/-	M	91/6-96/12	
			VOLVO 850 2,0 10V	1984 B5202S	G	*/-	A	91/6-96/12	
			VOLVO 850 2,0 20V	1984 B5202S	G	*/-	M	91/6-96/12	
			VOLVO 850 2,0 20V	1984 B5202S	G	*/-	A	91/6-96/12	
			VOLVO 850 2,0 TURBO 20V	1984 B5204T	G	*/-	M	93/9-96/12	
			VOLVO 850 2,0 TURBO 20V	1984 B5204T	G	*/-	A	93/9-96/12	
			VOLVO 850 2,3 20V	2319 B5234S	G	*/-	M	93/9-96/12	
			VOLVO 850 2,3 20V	2319 B5234S	G	*/-	A	93/9-96/12	
			VOLVO 850 2,3 TURBO 20V	2319 B5234T	G	*/-	M	93/9-96/12	
			VOLVO 850 2,3 TURBO 20V	2319 B5234T	G	*/-	A	93/9-96/12	
			VOLVO 850 2,5 10V	2435 B5252FS	G	*/-	M	91/6-96/12-	
			VOLVO 850 2,5 10V	2435 B5252FS	G	*/-	A	91/6-96/12-	
			VOLVO 850 2,5 10V	2435 B5252FS	G	*/-	M	91/6-96/12-	
			VOLVO 850 2,5 10V	2435 B5252FS	G	*/-	A	91/6-96/12-	
			VOLVO 850 2,5TDi	2461 D5252T	D	*/-	M	96/1-96/12	
			VOLVO 850 2,5TDi	2461 D5252T	D	*/-	A	96/1-96/12	
			VOLVO 850 2,5TURBO 20V	2435 B5254T	G	*/-	M	93/9-96/12	
			VOLVO 850 2,5TURBO 20V	2435 B5254T	G	*/-	A	93/9-96/12	
			VOLVO C70 2,0 T	1948 B5202T	G	*	M	91/01-00/01	
			VOLVO C70 2,0 T	1948 B5202T	G	*	A	91/01-00/01	
			VOLVO C70 2,3 T	2319 B5234T3	G	*	M	91/01-00/01	
			VOLVO C70 2,3 T	2319 B5234T3	G	*	A	91/01-00/01	
			VOLVO C70 2,4 T	2435 B5244T3	G	*/-	M	91/01-00/01	
			VOLVO C70 2,4 T	2435 B5244T3	G	*/-	A	91/01-00/01	
			VOLVO C70 2,4i	2435 B5244S	G	*	M	91/01-00/01	
			VOLVO C70 2,4i	2435 B5244S	G	*	A	91/01-00/01	
			VOLVO S70/V70 2,0 10V	1984 B5202S	G	*/-	M	96/12-98/12	
			VOLVO S70/V70 2,0 10V	1984 B5202S	G	*/-	M	99/01-00/01	
			VOLVO S70/V70 2,0 10V	1984 B5202S	G	*/-	A	96/12-98/12	
			VOLVO S70/V70 2,0 10V	1984 B5202S	G	*/-	A	99/01-00/01	
			VOLVO S70/V70 2,0T 20V	1948 B5202T	G	*/-	M	96/12-98/12	
			VOLVO S70/V70 2,0T 20V	1948 B5202T	G	*/-	M	99/01-00/01	
			VOLVO S70/V70 2,0T 20V	1948 B5202T	G	*/-	A	96/12-98/12	
			VOLVO S70/V70 2,0T 20V	1948 B5202T	G	*/-	A	99/01-00/01	
			VOLVO S70/V70 2,3 20V TURBO	2319 B5234T3	G	*/-	M	96/12-98/12	
			VOLVO S70/V70 2,3 20V TURBO	2319 B5234T3	G	*/-	M	99/01-00/01	
			VOLVO S70/V70 2,3 20V TURBO	2319 B5234T3	G	*/-	A	96/12-98/12	
			VOLVO S70/V70 2,3 20V TURBO	2319 B5234T3	G	*/-	A	99/01-00/01	
			VOLVO S70/V70 2,4i	2435 B5252	G	*/-	M	99/01-00/01	
			VOLVO S70/V70 2,4i	2435 B5252	G	*/-	A	99/01-00/01	
			VOLVO S70/V70 2,4T	2435 B5244T3	G	*/-	M	99/01-00/01	

№ФОРВАРДА	№ OEM	№ NISSENS	МОДЕЛЬ	ТИП ДВИГАТЕЛЯ	БЕН/Д ИЗ	ТИП КП	КОНД ИЦИ	ГОД	ПРИМЕЧА НИЕ
			VOLVO S70/V70 2,4T	2435 B5244T3	G	*/-	A	99/01-00/01	
			VOLVO S70/V70 2,5 10V	2435 B5252S	G	*/-	M	96/12-98/12	
			VOLVO S70/V70 2,5 10V	2435 B5252S	G	*/-	M	99/01-00/01	
			VOLVO S70/V70 2,5 10V	2435 B5252S	G	*/-	A	96/12-98/12	
			VOLVO S70/V70 2,5 10V	2435 B5252S	G	*/-	A	99/01-00/01	
			VOLVO S70/V70 2,5 10V	2435 B5252S	G	*/-	A	99/01-00/01	
			VOLVO S70/V70 2,5 10V	2435 B5252S	G	*/-	M	99/01-00/01	
			VOLVO S70/V70 2,5 20V	2435 B5252S	G	*/-	A	99/01-00/1	
			VOLVO S70/V70 2,5 20V	2435 B5254S	G	*/-	M	96/12-98/12	
			VOLVO S70/V70 2,5 20V	2435 B5254S	G	*/-	A	96/12-98/12	
			VOLVO S70/V70 2,5 20V TURBO	2435 B5254T	G	*/-	M	96/12-98/12	
			VOLVO S70/V70 2,5 20V TURBO	2435 B5254T	G	*/-	M	99/01-00/01	
			VOLVO S70/V70 2,5 20V TURBO	2435 B5254T	G	*/-	A	96/12-98/12	
			VOLVO S70/V70 2,5 20V TURBO	2435 B5254T	G	*/-	A	99/01-00/01	
			VOLVO S70/V70 2,5TDi	2461 D5252T	D	*/-	M	96/12-98/12	
			VOLVO S70/V70 2,5TDi	2461 D5252T	D	*/-	M	99/01-00/01	
			VOLVO S70/V70 2,5TDi	2461 D5252T	D	*/-	A	96/12-98/12	
			VOLVO S70/V70 2,5TDi	2461 D5252T	D	*/-	A	99/01-00/01	
			VOLVO XC 70 2,0 T	1948 B5202T	G	*/-	M	99/01-00/01	
			VOLVO XC 70 2,0 T	1948 B5202T	G	*/-	A	99/01-00/01	
			VOLVO XC 70 2,4 T	2435 B5244T3	G	*/-	M	99/01-00/01	
			VOLVO XC 70 2,4 T	2435 B5244T3	G	*/-	A	99/01-00/01	
			VOLVO XC 70 2,5 T	2435 B5254T	G	*/-	M	99/01-00/01	
			VOLVO XC 70 2,5 T	2435 B5254T	G	*/-	A	99/01-00/01	

VV94093-930 6848131/749 94216 940 '93- (+960 96-/S90/V90 96-) КОНДЕНСАТОР КОНДИЦ 605 410 24



940 2,0 i	B200F	G	*	M	90/9-96/12
940 2,0 i	B200F	G	*	A	90/9-96/12
940 2,0 i	B200F	G	*/-	M	92/9-96/12
940 2,0 i	B200F	G	*/-	A	92/9-96/12
940 2,0 i TURBO	B200FT	G	*	M/A	90/8-
940 2,3 i	B200F	G	*	M	90/9-96/12
940 2,3 i	B200F	G	*	A	90/9-96/12
940 2,3 i	B230F	G	*/-	M	92/9-96/12
940 2,3 i	B230F	G	*/-	A	92/9-96/12
940 2,0 i TURBO	B230FT	G	*	M/A	90/8-
940 2,4 D	D24	D		A	90/9-
S90 / V90 2,0 i TURBO	B200T	G	*/-	M	96/12-
S90 / V90 2,3 i TURBO	B200T	G	*/-	M	96/12-
S90 /V90 2,5 i	B6254FS	G	*/-	M	96/12-
S90 /V90 2,5 i	B6254FS	G	*/-	A	96/12-
S90 /V90 3,0 i	B6304S2	G	*/-	M	96/12-
S90 /V90 3,0 i	B6304S2	G	*/-	A	96/12-

VVS4095-930 30871579/30897260/4945635 94305 S40 '95- (+V40) КОНДЕНСАТОР КОНДИЦ (NISSENS) 660 348 16

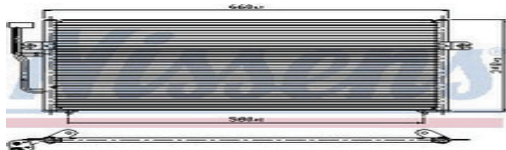

VOLVO S40/V40 1,6 i	1598B4164S	G	*/-	M	95/6-99/6
VOLVO S40/V40 1,8 i	1731B4184S	G	*/-	M	95/6-99/6
VOLVO S40/V40 1,9TDi	1866D4192T	D	*/-	M	95/6-99/6
VOLVO S40/V40 1,9TDi	D4192T2	D	*/-	M/A	99/6-01/6
VOLVO S40/V40 1,9TDi	D4192T3/T4	D	*/-	M/A	01/6-
VOLVO S40/V40 2,0i	1998B4204S	G	*/-	M	95/6-99/6
VOLVO S40/V40 2,0T	1948B4204T	G	*/-	M/A	95/6-

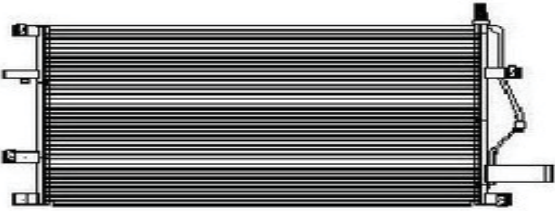
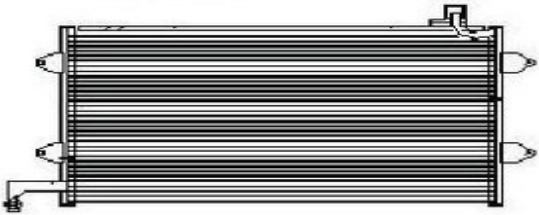
№ФОРВАРДА	№ OEM	№ NISSENS	МОДЕЛЬ	ТИП ДВИГАТЕЛЯ	БЕН/Д ИЗ	ТИП КП	КОНД ИЦИ	ГОД	ПРИМЕЧА НИЕ
VVS8098-930	6848889/9171651	94525	S80 '98- {(S70/V70/C70/XC70/S60 00-)} КОНДЕНСАТОР КОНДИЦ						635 425 20
			C70 2,0 T	1948 B5202T	G	*/-	M	00/2-	
			C70 2,0 T	1948 B5202T	G	*/-	M	00/2-	
			C70 2,3 T	2319 B5234T3	G	*/-	M	00/2-	
			C70 2,3 T	2319 B5234T3	G	*/-	M	00/9-	
			C70 2,4 T	2435 B5244T3	G	*/-	M	00/9-	
			C70 2,4 T	2435 B5244T3	G	*/-	M	00/9-	
			S60 2,0T	1998 B5204T5	G	*/-	M	00/9-	
			S60 2,0T	1998 B5204T5	G	*/-	M	00/9-	
			S60 T 5	2498 B5254T	G	*/-	M	00/9-	
			S80 2,0 T	1998 B5204T5	G	*/-	M	98/8-	
			S80 2,3 T	2332 B5234T	G	*/-	M	98/8-	
			S80 2,4 T	2435 B5244T3	G	*/-	M	98/8-	
			S80 2,4 T	2435 B5244T3	G	*/-	M	98/8-	
			S80 2,4 T	2435 B5244S	G	*/-	M	98/8-	
			S80 2,4 T	2435 B5244S	G	*/-	M	98/8-	
			S80 2,5 T	2498 B5254T	G	*/-	M	98/8-	
			S80 2,9 24V T6	2898 B6294T	G	*/-	M	98/9-	
			S80 2,9i 24V	2922 B6294S	G	*/-	M	98/8-	
			S70 / V70 2,0 T	1998 B5205T4	G	*/-	M	00/2-	
			S70 / V70 2,3 T	2332 B5234T	G	*/-	M	00/2-	
			S70 / V70 2,4 T	2435 B5244T3	G	*/-	M	00/2-	
		S70 / V70 2,4 i 10V	2435 B5252	G	*/-	M	00/2-		
		S70 / V70 2,4 i 20V	2435 B5254S4	G	*/-	M	00/2-		
		XC 70 2,3T	2332 B5234T	G	*/-	M	00/2-		
		XC 70 2,4T	2435 B5244T3	G	*/-	M	00/2-		
		XC 70 2,4D	2338 D5244T	G	*/-	M	00/2-		
VWGLF91-930	1H0820413	94164	GOLF '91-97 {+VENTO} КОНДЕНСАТОР КОНДИЦ						557 371 35
			GOLF III / VENTO 1,6 i	1595 AEK	G	M/A	*	94/10-95/12	
			GOLF III / VENTO 1,6 i	1595 AFT	G	M/A	*	95/7-97/12	
			GOLF III / VENTO 1,6 i	1595 AKS	G	M/A	*	95/7-97/12	
			GOLF III 1,8 i	1781 AAM	G	M	*	91/11-97/12	
			GOLF III 1,8 i	1781 AAM	G	A	*/-	91/11-97/12	
			VENTO 1,8 i	1781 AAM	G	M	*	91/11-97/12	
			VENTO 1,8 i	1781 AAM	G	A	*/-	91/11-97/12	
			GOLF III 1,8 i	1781 ABS	G	M/A	*	91/11-94/9	
			VENTO 1,8 i	1781 ABS	G	M/A	*	91/11-94/9	
			GOLF III 1,8 i	1781 ACC	G	M	*	95/4-97/12	
			GOLF III / VENTO 1,8 i	1781 ACC	G	M	*	95/4-97/12	
			GOLF III / VENTO 1,8 i	1781 ADZ	G	M/A	*	94/10-97/12	
			GOLF III / VENTO 2,0 i	1984 ABF	G	M	*	92/8-97/12	
			GOLF III / VENTO 2,0 i	1984 ADY	G	M/A	*	94/10-96/5	
			GOLF III 2,0 i	1984 AEP	G	M/A	*	95/1-97/12	
			GOLF III / VENTO 2,0 i	1984 AGG	G	M	*	95/7-97/12	
			GOLF III / VENTO 2,0 i	1984 AKR	G	M	*	97/5-97/12	
		GOLF III / VENTO 2,0 i	1984 2E	G	M/A	*	91/11-94/9		

№ФОРВАРДА	№ OEM	№ NISSENS	МОДЕЛЬ	ТИП ДВИГАТЕЛЯ	БЕН/Д ИЗ	ТИП КП	КОНД ИЦИ	ГОД	ПРИМЕЧА НИЕ
			GOLF III 2,8 VR6	2792 AAA	G	M	*	92/1-97/8	
			GOLF III 2,8 VR6	2792 AAA	G	M/A	*/-	92/1-97/12	
			GOLF III 2,9 VR6	2861 ABV	G	M	*	94/10-97/8	
			VENTO 2,8 i VR6	2792 AAA	G	M	*	92/1-98/9	
			VENTO 2,8 i VR6	2792 AAA	G	M/A	*/-	92/1-98/12	
			GOLF III 1,9 TD	1896 AAZ	D	M	*/-	91/11-97/12	
			GOLF III 1,9 TD	1896 AAZ	D	A	*/-	91/11-94/7	
			VENTO 1,9 TD	1896 AAZ	D	M	*/-	91/11-97/12	
			VENTO 1,9 TD	1896 AAZ	D	A	*/-	91/11-94/7	
			GOLF III /VENTO 1,9 TDi	1896 AFN	D	M/A	*/-	96/2-97/12	
			GOLF III /VENTO 1,9 TDi	1896 AHU	D	M/A	*	96/8-97/12	
			GOLF III /VENTO 1,9 TDi	1896 ALE	D	M	*	97/5-97/12	
			GOLF III /VENTO 1,9 TDi	1896 IZ	D	M/A	*	93/8-96/7	

VWGLF04-930 1K0820411F/H 94684 GOLF [+ AU A3 03-/SD OCTAVIA 04-] КОНДЕНСАТОР КОНДИЦ (NISSENS) 580 401 16

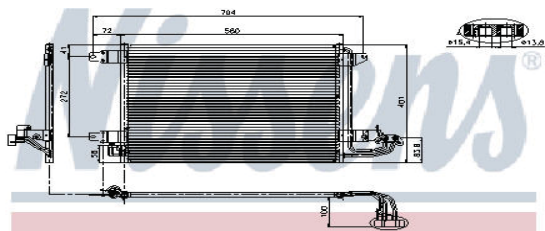

A 3 / S 3 (03-) 1.4 TSI	CAX	G	M	+/-	05/03 -
A 3 / S 3 (03-) 1.6 FSI	BAG/BLF/BLP	G	M	+/-	05/03 -
A 3 / S 3 (03-) 1.6 i 16V	BGU/BSE/BSF	G	M/A	+	05/03 -
A 3 / S 3 (03-) 1.8 FSI	BPT/BPU	G	M/A	+	05/03 -
A 3 / S 3 (03-) 1.8 TFSI	BYT/BZB	G	M/A	+	05/03 -
A 3 / S 3 (03-) 1.9 Tdi	BKC/BLS/BXE	G	M	+	05/03 -
A 3 / S 3 (03-) 2.0 Fsi	AXW/BVZ/BVY/BUY/BMB/B	G	M/A	+	05/03 -
A 3 / S 3 (03-) 2.0 PD Tdi	AZV/BMN/BMM/BKD	G	M/A	+	05/03 -
A 3 / S 3 (03-) 2.0 TFSi	AXX/CAW/BZC/BPY/BHZ	G	M/A	+	05/03 -
A 3 / S 3 (03-) 3.2 i V6	BDB/BUB/BMJ	G	M/A	+	05/03 -
ALTEA (04-) 1.4 i 16V	BXW	G	M	+/-	03/04 -
ALTEA (04-) 1.9 Tdi	BLS	D	M	+/-	09/05 -
ALTEA (04-) 1.4 TSI	CAX	G	M	+/-	03/04 -
ALTEA (04-) 1.6 i 16V	BGU/BSF/BSE	G	M	+/-	03/04 -
ALTEA (04-) 1.8 TFSI	BYT/BZB	G	M	+/-	03/04 -
ALTEA (04-) 1.9 Tdi	BJB/BKC/BXE	D	M	+/-	04/04 -
ALTEA (04-) 2.0 Fsi	BLR/BLY	G	M	+/-	05/04 -
ALTEA (04-) 2.0 Fsi	BLR/BLY/BVY/BVZ	G	A	+/-	05/04 -
ALTEA (04-) 2.0 TFSi	AXX/BWA	G	M/A	+/-	05/04 -
ALTEA (04-) 2.0 PD Tdi	AZV/BWA/BMN/BMM/BKD	D	M/A	+/-	04/04 -
LEON (05-) 1.4 i 16V	BCA/BXW/BUD	G	M	+/-	09/05 -
LEON (05-) 1.4 TSI	CAX	G	M/A	+/-	09/05 -
LEON (05-) 1.6 i 16V	BGU/BSF/BSE	G	M	+/-	09/05 -
LEON (05-) 1.8 TFSI	BZB	G	M/A	+/-	09/05 -
LEON (05-) 1.9 Tdi	BKC/BXE/BLS	D	M	+/-	09/05 -
LEON (05-) 2.0 Fsi	BLR/BVZ/BVY/BLY	G	M/A	+/-	09/05 -
LEON (05-) 2.0 PD Tdi	AZV/BMN	D	M/A	+/-	09/05 -
LEON (05-) 2.0 PD Tdi	BKD/BMM	G	M/A	+/-	09/05 -
LEON (05-) 2.0 TFSi	AXX/BWJ/BWA	G	M/A	+/-	09/05 -
TOLEDO (04-) 1.4 i 16V	BUD/BXW	G	M	+/-	03/04 -
TOLEDO (04-) 1.4 TSI	CAX	G	M/A	+/-	09/05 -
TOLEDO (04-) 1.6 i 16V	BGU/BSF/BSE	G	M	+/-	03/04 -
TOLEDO (04-) 1.8 TFSI	BYT/BZB	G	M/A	+/-	09/05 -
TOLEDO (04-) 1.9 Tdi	BJB/BXE/BLS/BKC	D	M	+/-	04/04 -
TOLEDO (04-) 2.0 Fsi	BLR/BVZ/BVY/BLY	G	M/A	+/-	05/04 -
TOLEDO (04-) 2.0 PD Tdi	AZV/BMN/BMM/BKD	D	M/A	+/-	04/04 -
TOLEDO (04-) 2.0 TFSi	AXX/BWA	G	M/A	+/-	05/04 -
OCTAVIA (04-) 1.4 i 16V	BCA/BUD	G	M	+/-	05/04 -

№ФОРВАРДА	№ OEM	№ NISSENS	МОДЕЛЬ	ТИП ДВИГАТЕЛЯ	БЕН/Д ИЗ	ТИП КП	КОНД ИЦИ	ГОД	ПРИМЕЧА НИЕ
			OCTAVIA (04-) 1.6 i 16V	BGU/BSE/BSF/BLF	G	M	+/-	05/04 -	
			OCTAVIA (04-) 1.6 i 16V	BGU/BSE/BSF/BLF	G	A	+	05/04 -	
			OCTAVIA (04-) 1.9 Tdi	BJB/BKC/BLS/BXE	D	M	+/-	05/04 -	
			OCTAVIA (04-) 1.9 Tdi	BKC	D	A	+/-	05/04 -	
			OCTAVIA (04-) 2.0 PD Tdi	AZV/BMM/BKD	D	M/A	+	05/04 -	
			OCTAVIA (04-) 2.0 TFSi	BWA	G	M	+	05/04 -	
			OCTAVIA (04-) 2.0 Fsi	BLR/BVZ/BVY/BLY/BVX/BL	G	M/A	+	11/04 -	
			EOS (06-) 1.6 FSI	BLF	G	M/A	+/-	05/06 -	
			EOS (06-) 2.0 Fsi	BVY/BVZ	G	M/A	+/-	05/06 -	
			EOS (06-) 2.0 PD Tdi	BMM	D	M/A	+/-	05/06 -	
			EOS (06-) 2.0 TFSi	BWA	G	M/A	+/-	05/06 -	
			EOS (06-) 3.2 i V6	BUB	G	M/A	+/-	05/06 -	
			GOLF V (03-) 1.4 FSI	BLN/BUD/BKG	G	M	+/-	10/03 -	
			GOLF V (03-) 1.4 i 16V	BCA/AHW	G	M	+/-	10/03 -	
			GOLF V (03-) 1.4 TSI	BLG/BMY	G	M	+/-	10/03 -	
			GOLF V (03-) 1.6 i 16V	BGU/BSF/BSE	G	M/A	+/-	01/04 -	
			GOLF V (03-) 1.6 FSI	BAG/BLP	G	M	+/-	10/03 -	
			GOLF V (03-) 1.6 FSI	BLF	G	M/A	+/-	10/03 -	
			GOLF V (03-) 2.0 Fsi	AXW/BVZ/BVY/BVX/BLY/B	G	M/A	+/-	10/03 -	
			GOLF V (03-) 2.0 TFSi	AXX/BYD/BWA/BPY	G	M/A	+/-	09/04 -	
			GOLF V (03-) 3.2 i V6	BUB	G	M/A	+/-	09/04 -	
			GOLF V (03-) 1.9 Tdi	BJB/BXF/BXE/BLS	D	M/A	+/-	10/03 -	
			GOLF V (03-) 2.5 i	BGP/BGQ/BTK	G	M/A	+/-	09/05 -	
			GOLF V (03-) 1.9 Tdi	BKC/BRU	D	M/A	+/-	10/03 -	
			GOLF V (03-) 2.0 SDI	BDK	D	M	+/-	01/04 -	
			GOLF V (03-) 2.0 PD Tdi	AZV/BVB/BMN/BMM/BKD	D	M/A	+/-	10/03 -	
			JETTA (05-) 1.4 TSI	BLG/BMY	G	M/A	+/-	09/05 -	
			JETTA (05-) 1.6 FSI	BLF	G	M	+/-	09/05 -	
			JETTA (05-) 1.6 FSI	BLF	G	A	+/-	09/05 -	
			JETTA (05-) 1.6 FSI	BSE/BSF	G	M/A	+/-	09/05 -	
			JETTA (05-) 1.9 Tdi	BKC/BXE/BRM/BLS	D	M/A	+/-	09/05 -	
			JETTA (05-) 2.0 Fsi	BLR/BVZ/BVY/BLY	G	M/A	+/-	09/05 -	
			JETTA (05-) 2.0 PD Tdi	AZV/BMM/BKD	D	M/A	+/-	09/05 -	
			JETTA (05-) 2.0 TFSi	BPY/BWA	G	M/A	+/-	09/05 -	
			JETTA (05-) 2.5 i	BGP/BTK/BGQ	G	M/A	+/-	09/05 -	
			TIGUAN (07-) 2.0 Fsi	AXW/BVZ/BVY/BVX/BLY/B	G	M/A	+/-	06/07 -	
			TIGUAN (07-) 2.0 PD Tdi	AZV/BVB/BMN/BMM/BKD	D	M/A	+/-	06/07 -	
			TIGUAN (07-) 2.0 TFSi	AXX/BYD/BWA/BPY	G	M/A	+/-	06/07 -	
VWPAS88-930	357820413A	94174	PASSAT '88-91 КОНДЕНСАТОР КОНДИЦ (NISSENS)						683 308 35
VWPAS88-931	357820413A	94174	PASSAT '88-91 КОНДЕНСАТОР КОНДИЦ						683 308 35
			PASSAT 1,6 i	1595 EZ	G	A	*	4/88-7/91	
			PASSAT 1,6 i	1595 RF	G	M/A	*	88/4-89/7	
			PASSAT 1,6 i	1595 1F	G	M/A	*	88/8-90/7	
			PASSAT 1,8 i	1781 ABS	G	M/A	*	91/8-93/10	
			PASSAT 1,8 i	1781 PB	G	M/A	*	88/4-90/7	
			PASSAT 1,8 i	1781 PF	G	M/A	*	88/4-90/7	
			PASSAT 1,8 i	1781 RP	G	M/A	*	88/4-91/7	
			PASSAT 1,8 i 16V	1781 KR	G	A	*	88/4-91/7	
			PASSAT 2,0 i	1984 2E	G	M/A	*	90/3-93/10	
			PASSAT 2,0 i	1984 9A	G	M/A	*	88/4-93/10	
			PASSAT 2,8 i VR6	2792 AAA	G	A	*/-	91/6-93/10	

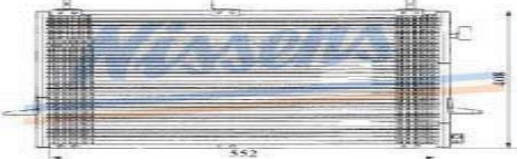

№ ФОРВАРДА	№ OEM	№ NISSENS	МОДЕЛЬ	ТИП ДВИГАТЕЛЯ	БЕН/Д ИЗ	ТИП КП	КОНД ИЦИ	ГОД	ПРИМЕЧА НИЕ
VWPAS93-930	3A0820413A	94179	PASSAT '93-96 КОНДЕНСАТОР КОНДИЦ (NISSENS)						682 333 35
			PASSAT 1,6 i 8V	1588 AEK	G	A	*	94/10-95/12	
			PASSAT 1,6 i 8V	1589 AEK	G	M	*	94/10-95/12	
			PASSAT 1,6 i 8V	1588 AFT	G	A	*	95/12-96/12	
			PASSAT 1,6 i 8V	1589 AFT	G	M	*	95/12-96/12	
			PASSAT 1,8 i 8V	1781AAM	G	A	*	93/10-96/12	
			PASSAT 1,8 i 8V	1781 ABS	G	M	*	93/10-94/9	
			PASSAT 1,8 i 8V	1781ABS	G	A	*	93/10-94/9	
			PASSAT 1,8 i 8V	1781ADZ	G	M	*	94/8-96/12	
			PASSAT 1,8 i 8V	1781ADZ	G	A	*	94/1-96/12	
			PASSAT 2,0 i	1984ABF	G	M	*	94/1-96/12	
			PASSAT 2,0 i	1984ACX	G	M	*	94/3-94/12	
			PASSAT 2,0 i	1998ACX	G	A	*	94/3-94/12	
			PASSAT 2,0 i	1998ADY	G	M	*	94/10-95/7	
			PASSAT 2,0 i	1998ADY	G	A	*	94/10-95/7	
			PASSAT 2,0 i	1998AEP	G	M	*	95/3-96/12	
			PASSAT 2,0 i	1998AEP	G	A	*	95/3-96/12	
			PASSAT 2,0 i	1984AGG	G	M	*	95/7-96/12	
			PASSAT 2,0 i	1984AGG	G	A	*	95/7-96/12	
			PASSAT 2,0 i	1984 2F	G	M	*	93/10-94/9	
			PASSAT 2,0 i	1985 2F	G	A	*	93/10-94/9	
			PASSAT 2,8 i VR6	2792 AAA	G	M	*/-	93/10-96/12	
			PASSAT 2,8 i VR6	2792AAA	G	A	*/-	93/10-96/12	
			PASSAT 1,9 TD	1896AAZ	D	M	*/-	93/10-96/12	
			PASSAT 1,9 Tdi	1896AFN	D	M/A	*	93/3-96/12	
			PASSAT 1,9 TDi	1896AHU	D	M/A	*	96/8-96/12	
PASSAT 1,9 TDi	1896 IZ	D	M/A	*	93/10-96/12				
PASSAT 2,9 i VR6	2861ABV	G	M	*/-	93/10-96/9				
VWPLO94-930	6N0820413A/B	94260	POLO '94-99 КОНДЕНСАТОР КОНДИЦ (NISSENS)						355 350 37
			AROSA 1,4 i	1390 AEX	G	A	*/-	97/2-97/11	
			AROSA 1,4 i	1390 AKK	G	A	*/-	99/7-00/10	
			AROSA 1,4 i	1390 AKV	G	A	*/-	97/5-99/9	
			AROSA 1,4 i	1390 ANW	G	A	*/-	99/7-00/10	
			AROSA 1,4 i	1390 APQ	G	A	*/-	97/12-98/8	
			LUPO 1,4 i 16V	1391 AHW	G	A	*/-	99/1-03/5	
			LUPO 1,4 i 16V	1391 AKQ	G	A	*/-	98/10-99/5	
			LUPO 1,4 i 16V	1391 APE	G	A	*/-	99/5-00/5	
			POLO 1,4 i	1390 AEX	G	A	*/-	95/7-97/12	
			POLO 1,4 i	1390 AKV	G	A	*/-	97/5-99/12	
			POLO 1,4 i	1390 ANX	G	A	*/-	98/1-99/12	
			POLO 1,4 i	1390 APQ	G	A	*/-	97/11-99/12	
			POLO 1,6 i	1598 AEE	G	A	*/-	95/7-99/12	

№ФОРВАРДА	№ OEM	№ NISSENS	МОДЕЛЬ	ТИП ДВИГАТЕЛЯ	БЕН/Д ИЗ	ТИП КП	КОНД ИЦИ	ГОД	ПРИМЕЧА НИЕ
VWSRN95-930	1008274/1009526/1015261/1029057/7266163	94251	SHARAN '95-00 {+ FD GALAXY/ST ALHAMBRA} КОНДЕНСАТОР КОНДИЦ						600 371 20
			GALAXY 2,0 i	1998	G	*/-	M/A	95/10-	
			GALAXY 2,3 i 16V	2295	G	*/-	M/A	95/10-	
			GALAXY 2,8 i V6	2792	G	*/-	M/A	95/10-	
			GALAXY 1,9 Tdi	1896	D	*/-	M/A	95/10-	
			ALHAMBRA 1,8 i 20V TURBO	1781 AJH	G	*/-	M/A	98/5-00/2	
			ALHAMBRA 2,0 i	1984 ADY	G	*/-	M/A	96/3-00/2	
			ALHAMBRA 1,9 Tdi	1896 AFN	D	*/-	M/A	97/9-00/2	
			ALHAMBRA 1,9 Tdi	1896 AHU	D	*/-	M	97/5-00/2	
			ALHAMBRA 1,9 Tdi	1896 1Z	D	*/-	M	96/3-96/7	
			SHARAN 1,8 i 20V TURBO	1781 AJH	G	*/-	M/A	97/11-00/2	
			SHARAN 2,0 i	1984 ADY	G	*/-	M	95/9-00/2	
			SHARAN 2,0 i	1984 ADY	G	*/-	A	95/9-00/2	
			SHARAN 2,8 i VR6	2792 AAA	G	*/-	M	95/9-98/3	
			SHARAN 2,8 i VR6	2792 AAA	G	*/-	A	95/9-98/3	
			SHARAN 2,8 i VR6	2792 AMY	G	*/-	M	98/4-00/2	
			SHARAN 2,8 i VR6	2792 AMY	G	*/-	A	98/00/2	
			SHARAN 1,9 Tdi	1896 AFN	D	*/-	M/A	96/12-99/7	
			SHARAN 1,9 Tdi	1896 AHU	D	*/-	M	96/8-00/2	
			SHARAN 1,9 Tdi	1896 ANU	D	*/-	M	99/3-00/2	
			SHARAN 1,9 Tdi	1896 AVG	D	*/-	M/A	99/8-00/2	
			SHARAN 1,9 Tdi	1896 1Z	D	*/-	M	95/9-96/7	



РАДИАТОРЫ ОТОПИТЕЛЯ

AI08087-900	893819031A/B	70221	AUDI 80 '87-94 {90 87-94 /A4 95-} РАДИАТОР ОТОПИТЕЛЯ ()					232 154 33
AI08087-901	893819031A/B	70221	AUDI 80 '87-94 {90 87-94 /A4 95-} РАДИАТОР ОТОПИТЕЛЯ (NISSENS)					232 154 33





80 III	9/86-8/91
90 II	9/86-9/91
A4	11/94-

AI10076-900	443819031B/C/030	70220	AUDI 100 '76-94 {200/A6 94-97/} РАДИАТОР ОТОПИТЕЛЯ (NISSENS)					272 150 30
AI10076-901	443819031A/B/C/443819030	70220	AUDI 100 '76-94 {200/A6 94-97/} РАДИАТОР ОТОПИТЕЛЯ					272 150 30

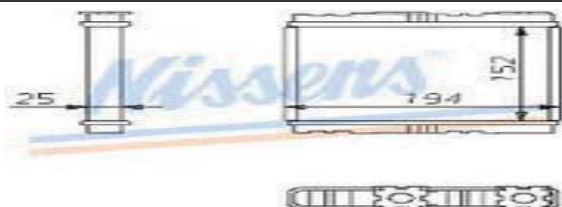
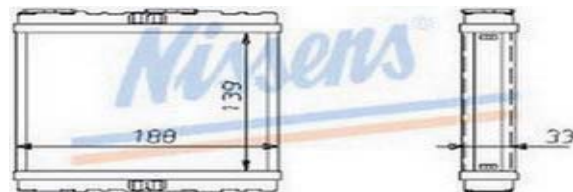

200	10/79-7/82
100 II	7/76-7/82
100 III	8/82-11/90
100 IV	12/90-7/94
200 II	8/83-
A6	7/94-
AUDI V8	11/90-

№ФОРВАРДА	№ OEM	№ NISSENS	МОДЕЛЬ	ТИП ДВИГАТЕЛЯ	БЕН/Д ИЗ	ТИП КП	КОНД ИЦИ	ГОД	ПРИМЕЧА НИЕ
FDSIE83-900	1652127	71761	SIERRA '83-93 {SCORPIO 85-/ESCORT 84-86 90-95} РАДИАТОР ОТОПИТЕЛЯ						249 132 33
			ESCORT II 1,3 LX/1,6LX ESCORT V 2,0EFI 16V RS GRANADA 85 SCORPIO SIERRA	1998 DH20	G			84-86 8/90-1/95 3/85- 4/85- 9/82-3/93	
MD20183-900	28355401	72002	W201 '83-93 РАДИАТОР ОТОПИТЕЛЯ (NISSENS)						293 152 40
			W201					9/83-6/93	
NNMX189-900		73700	MAXIMA '89-99 {SB LEGASY 89-99} РАДИАТОР ОТОПИТЕЛЯ (NISSENS)						140 190 25
			LEGACY MAXIMA		G			89-99 89-99	
NNP1090-900	5658030101/2714061J15	72200	P10 '90-96 РАДИАТОР ОТОПИТЕЛЯ (NISSENS)						139 188 33
			PRIMERA 4WD PRIMERA P10 SUNNY					8/91- 7/90- /91-	

№ФОРВАРДА	№ OEM	№ NISSENS	МОДЕЛЬ	ТИП ДВИГАТЕЛЯ	БЕН/Д ИЗ	ТИП КП	КОНД ИЦИ	ГОД	ПРИМЕЧА НИЕ
			VECTRA A (88-)	C18NZ	G	A	-	09/88 - 09/95	
			VECTRA A (88-)	20SEH/C20NE	G	M	-	09/88 - 09/95	
			VECTRA A (88-)	20SEH/C20NE	G	A	-	09/88 - 09/95	
			VECTRA A (88-)	C20XE/X20XEV	G	M	-	09/88 - 09/95	
			VECTRA A (88-)	C20XE/X20XEV	G	A	-	09/88 - 09/95	
			VECTRA A (88-)	17D/17DR	D	M	-	09/88 - 09/95	
			VECTRA A (88-)	17D/17DR	D	A	-	09/88 - 09/95	
			VECTRA A (88-)	TC4EC1	D	M	+/-	09/88 - 09/95	
			CAVALIER (88-)	14NV	G	M	-	09/88 -	
			CAVALIER (88-)	C16NZ/X16SZ	G	A	-	09/88 - 09/95	
			CAVALIER (88-)	C16NZ/X16SZ	G	M	-	09/88 - 09/95	
			CAVALIER (88-)	C18NZ	G	M	-	09/88 - 09/95	
			CAVALIER (88-)	C18NZ	G	A	-	09/88 - 09/95	
			CAVALIER (88-)	20SEH/C20NE	G	M	-	09/88 - 09/95	
			CAVALIER (88-)	20SEH/C20NE	G	A	-	09/88 - 09/95	
			CAVALIER (88-)	C20XE/X20XEV	G	M	-	09/88 - 09/95	
			CAVALIER (88-)	C20XE/X20XEV	G	A	-	09/88 - 09/95	
			CAVALIER (88-)	17D/17DR	D	M	-	09/88 - 09/95	
			CAVALIER (88-)	17D/17DR	D	A	-	09/88 - 09/95	
			CAVALIER (88-)	TC4EC1	D	M	+/-	09/88 - 09/95	
VWPAS88-900	1H1819031A/191819031F/B/C/D	73962	PASSAT '88-96 {CORDOBA/IBIZA/A3/GOLF(ВСЕ)VENT/POLO 96-} РАДИАТОР ОТОПИТЕЛЯ (NISSENS)						234 157 33
VWPAS88-901	1H1819031A/191819031B/C/D/F	73962	PASSAT '88-96 {CORDOBA/IBIZA/A3/GOLF(ВСЕ)VENT/POLO 96-} РАДИАТОР ОТОПИТЕЛЯ						234 157 33
			A3					9/96-	
			AROSA			MA	*/-	5/97-	
			CADDY II					10/95-	
			CORDOBA					12/93-	
			CORRADO					9/88-	
			GOLF II					9/83-8/91	
			GOLF III					9/91-	
			GOLF IV					11/97-	
			IBIZA II					5/93-	
			INCA					4/95-	
			JETTA II					3/84-	
			OCTAVIA					10/96-	
			PASSAT III					4/88-9/93	
			PASSAT IV					10/93-9/96	
			POLO IV					10/94-	
			SCIROCCO II					9/83-	
			TOLEDO					5/91-	
			VENTO					1/92-	
VWTRN90-900	701819031A/B	73965	TRANSPORTER '90- РАДИАТОР ОТОПИТЕЛЯ (NISSENS)						212 139 42
VWTRN90-901	701819031A/B	73965	TRANSPORTER '90- РАДИАТОР ОТОПИТЕЛЯ						212 139 42
			TRANSPORTER II					9/90-	

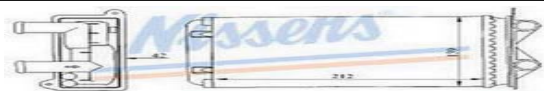
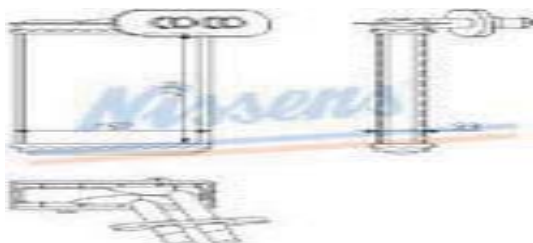

№ФОРВАРДА	№ OEM	№ NISSENS	МОДЕЛЬ	ТИП ДВИГАТЕЛЯ	БЕН/Д ИЗ	ТИП КП	КОНД ИЦИ	ГОД	ПРИМЕЧА НИЕ
СПИСОК СОКРАЩЕНИЙ ИСПОЛЪЗУЕМЫХ В КАТАЛОГЕ									
G	Бензиновый двигатель		ИТАЛИЯ или КИТАЙ						Страна производитель
D	Дизельный двигатель		(БРЭНД)						Производитель
V	V-образный тип двигателя		П/КОРРЕКТОР						Необходима обязат. установка электро корректора угла наклона фар
АилиАТ	Автоматическая коробка передач		БЕЗ КОРРЕКТОР						Регулировка угла наклона фар выполняется в ручную
МилиМТ	Механическая коробка передач		+/- КОРРЕКТОР						Установка электро корректора угла наклона фар не имеет значения
*	Наличие кондиционера		С РЕГ.МОТОРОМ						Электро корректор угла наклона фар установлен
-	Нет кондиционера		FLAT						Плоское зеркало
*/-	Наличие кондиционера не имеет значения		CONVEX						Выпуклое зеркало
USA	Только для Америка		ASPHERICAL						Двухзонное зеркало
ЯПОНИЯ	Только для Япония		ГРУНТ						Загрунтованно под покраску
+	Используется так же для...		LHD						Левый руль
HD	Для тяжелых условий работы		RHD						Правый руль
HP	Лошадиная сила		LD						Лево сторонее движение
КАТ	Катализатор		RD						Право сторонее движение
R12/R134A	Тип фреона		П/						Под
(БРЭНД-ТИП)	Тип производителя "оem"		ДВ						Дверь
WAFTC	Интеркулер		ЭКОНОМИЧНЫЙ						Используется другой типпластмасы